

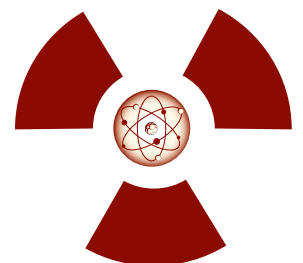

Rapid Radiochemical Methods for Selected Radionuclides in Water for Environmental Restoration Following Homeland Security Events

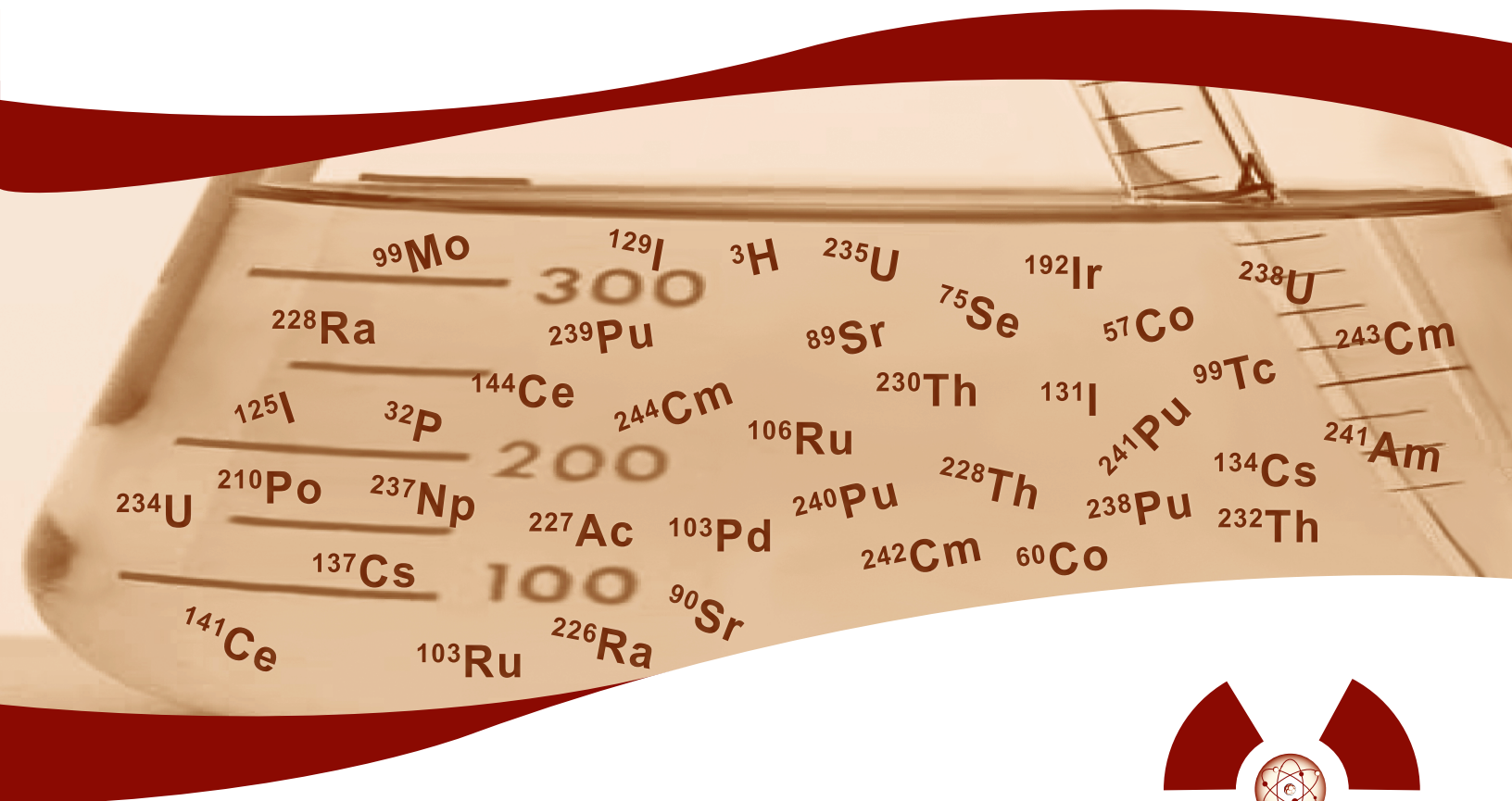

EPA 402-R-10-001
www.epa.gov/narel
February 2010
Revision 0

Rapid Radiochemical Methods for Selected Radionuclides in Water for Environmental Restoration Following Homeland Security Events

U.S. Environmental Protection Agency

**Office of Air and Radiation
Office of Radiation and Indoor Air
National Air and Radiation Environmental Laboratory
Montgomery, AL 36115**

**Office of Research and Development
National Homeland Security Research Center
Cincinnati, OH 45268**

This report was prepared for the National Air and Radiation Environmental Laboratory of the Office of Radiation and Indoor Air and the National Homeland Security Research Center of the Office of Research and Development, United States Environmental Protection Agency. It was prepared by Environmental Management Support, Inc., of Silver Spring, Maryland, under contracts 68-W-03-038, work assignment 43, and EP-W-07-037, work assignments B-41 and I-41, all managed by David Garman. Mention of trade names or specific applications does not imply endorsement or acceptance by EPA.

Preface

This compendium provides rapid radioanalytical methods for selected radionuclides in an aqueous matrix. These new methods were developed to expedite the analytical turnaround time necessary to prioritize sample processing while providing quantitative results that meet measurement quality objectives applicable to the intermediate and recovery phases of a nuclear or radiological incident of national significance, such as the detonation of an improvised nuclear device or a radiological dispersal device. It should be noted that these methods were not developed for compliance monitoring of drinking water samples, and they should not be considered as having EPA approval for that or any other regulatory program.

This is the first issue of rapid methods for americium-241, plutonium-238 and plutonium-239/240, isotopic uranium, radiostrontium (strontium-90), and radium-226. They have been single-laboratory validated in accordance with the guidance in *Method Validation Guide for Qualifying Methods Used by Radiological Laboratories Participating in Incident Response Activities, Validation and Peer Review of U.S. Environmental Protection Agency Radiochemical Methods of Analysis*, and Chapter 6 of *Multi-Agency Radiological Laboratory Analytical Protocols Manual (MARLAP)*. Depending on the availability of resources, EPA plans to perform multi-laboratory validations on these methods.

These methods are capable of achieving a required relative method uncertainty of 13% at or above a default analytical action level based on conservative risk or dose values for the intermediate and recovery phases. The methods also have been tested to determine the time within which a batch of samples can be analyzed. For these radionuclides, results for a batch of samples can be provided within a turnaround time of about 8 to 38 hours instead of the days to weeks required by some previous methods.

The need to ensure adequate laboratory infrastructure to support response and recovery actions following a major radiological incident has been recognized by a number of federal agencies. The Integrated Consortium of Laboratory Networks (ICLN), created in 2005 by 10 federal agencies,¹ consists of existing laboratory networks across the federal government. The ICLN is designed to provide a national infrastructure with a coordinated and operational system of laboratory networks that provide timely, high-quality, and interpretable results for early detection and effective consequence management of acts of terrorism and other events requiring an integrated laboratory response. It also designates responsible federal agencies (RFAs) to provide laboratory support across response phases for chemical, biological, and radiological agents. To meet its RFA responsibilities for environmental samples, EPA has established the Environmental Response Laboratory Network (ERLN) to address chemical, biological, and radiological threats. For radiological agents, EPA is the RFA for monitoring, surveillance, and remediation, and will share responsibility for overall incident response with the U.S. Department of Energy (DOE). As part of the ERLN, EPA's Office of Radiation and Indoor Air is leading an initiative to ensure that sufficient environmental radioanalytical capability and competency exist across a core set of laboratories to carry out EPA's designated RFA responsibilities.

¹ Departments of Agriculture, Commerce, Defense, Energy, Health and Human Services, Homeland Security, Interior, Justice, and State, and the U.S. Environmental Protection Agency.

EPA's responsibilities, as outlined in the *National Response Framework*, include response and recovery actions to detect and identify radioactive substances and to coordinate federal radiological monitoring and assessment activities. This document was developed to provide guidance to those radioanalytical laboratories that will support EPA's response and recovery actions following a radiological or nuclear incident of national significance.

As with any technical endeavor, actual radioanalytical projects may require particular methods or techniques to meet specific measurement quality objectives. Sampling and analysis following a radiological or nuclear incident will present new challenges in terms of types of matrices, sample representativeness, and homogeneity not experienced with routine samples. A major factor in establishing measurement quality objectives is to determine and limit the uncertainties associated with each aspect of the analytical process.

These methods supplement guidance in a planned series designed to present radioanalytical laboratory personnel, Incident Commanders (and their designees), and other field response personnel with key laboratory operational considerations and likely radioanalytical requirements, decision paths, and default data quality and measurement quality objectives for samples taken after a radiological or nuclear incident, including incidents caused by a terrorist attack.

Documents currently completed or in preparation include:

- *Radiological Laboratory Sample Analysis Guide for Incidents of National Significance – Radionuclides in Water* (EPA 402-R-07-007, January 2008)
- *Radiological Laboratory Sample Analysis Guide for Incidents of National Significance – Radionuclides in Air* (EPA 402-R-09-007, June 2009)
- *Radiological Laboratory Sample Screening Analysis Guide for Incidents of National Significance* (EPA 402-R-09-008, June 2009)
- *Method Validation Guide for Qualifying Methods Used by Radiological Laboratories Participating in Incident Response Activities* (EPA 402-R-09-006, June 2009)
- *Guide for Laboratories – Identification, Preparation, and Implementation of Core Operations for Radiological or Nuclear Incident Response* (EPA 402-R-10-002, June 2010)
- *A Performance-Based Approach to the Use of Swipe Samples in Response to a Radiological or Nuclear Incident* (in preparation)
- *Guide for Radiological Laboratories for the Control of Radioactive Contamination and Radiation Exposure* (in preparation)
- *Radiological Laboratory Sample Analysis Guide for Radiological or Nuclear Incidents – Radionuclides in Soil* (in preparation)

Comments on this document, or suggestions for future editions, should be addressed to:

Dr. John Griggs

U.S. Environmental Protection Agency

Office of Radiation and Indoor Air

National Air and Radiation Environmental Laboratory

540 South Morris Avenue

Montgomery, AL 36115-2601

(334) 270-3450

Griggs.John@epa.gov

Acknowledgments

These methods were developed by the National Air and Radiation Environmental Laboratory (NAREL) of EPA's Office of Radiation and Indoor Air (ORIA) in cooperation with and funding from the National Homeland Security Research Center (NHSRC) of the Office of Research and Development. Dr. John Griggs was the project lead for this document. Several individuals provided valuable support and input to this document throughout its development. Special acknowledgment and appreciation are extended to Kathy Hall, of NHSRC. We also wish to acknowledge the valuable suggestions provided by Cynthia White and her colleagues at Sanford Cohen & Associates' Southeastern Laboratory and Stephen Workman and his colleagues of ALS-Paragon Laboratories, who conducted the method-validation studies. Dr. Keith McCroan, of NAREL, provided significant assistance with the equations used to calculate minimum detectable concentrations and critical levels. A special thank you is extended to Dan Mackney, also of NAREL, for his review and comments. Numerous other individuals, both inside and outside of EPA, provided comments and criticisms of these methods, and their suggestions contributed greatly to the quality, consistency, and usefulness of the final methods. Technical support was provided by Dr. N. Jay Bassin, Dr. Anna Berne, Mr. David Burns, Dr. Carl V. Gogolak, Dr. Robert Litman, Dr. David McCurdy, Mr. Robert Shannon, and Ms. M. Leca Buchan of Environmental Management Support, Inc.

CONTENTS

Acronyms, Abbreviations, Units, and Symbols.....v
Radiometric and General Unit Conversions vii
Americium-241 in Water: Rapid Method for High-Activity Samples ²⁴¹Am – Page 1
Plutonium-238 and Plutonium-239/240 in Water: Rapid Method for High-Activity
Samples..... ^{238,239/240}Pu – Page 1
Radium-226 in Water: Rapid Method Technique for High-Activity Samples ²²⁶Ra – Page 1
Total Radiostrontium (Sr-90) in Water: Rapid Method for High-Activity Samples ⁹⁰Sr – Page 1
Isotopic Uranium in Water: Rapid Method for High-Activity Samples.....U-nat – Page 1

Acronyms, Abbreviations, Units, and Symbols

α	probability of a Type I decision error
AAL	analytical action level
ACS	American Chemical Society
ADL	analytical decision level
APS	analytical protocol specification
β	probability of a Type II decision error
Bq	becquerel
Ci	curie
cm	centimeter (10^{-2} meter)
cpm	counts per minute
cps	counts per second
CRM	certified reference material (see also SRM)
CSU	combined standard uncertainty
d	day
dpm	disintegrations per minute
DOE	Department of Energy
dps	disintegrations per second
DRP	discrete radioactive particle
EPA	U.S. Environmental Protection Agency
FWHM	full width at half maximum
g	gram
GPC	gas-flow proportional counter
h	hour
ICP-AES	inductively coupled plasma – atomic emission spectrometry
ICLN	Integrated Consortium of Laboratory Networks
ID	[identifier] [identification number]
I.D.	inside diameter
IND	improvised nuclear device
keV	kiloelectronvolts (10^3 electronvolts)
L	liter
LCS	laboratory control sample
m	meter
M	molar
MARLAP	<i>Multi-Agency Radiological Laboratory Analytical Protocols Manual</i>
MDC	minimum detectable concentration
MeV	megaelectronvolts (10^6 electronvolts)
min	minute
mg	milligram (10^{-3} gram)
mL	milliliter (10^{-3} liter)
mm	millimeter (10^{-3} meter)
MQO	measurement quality objective
NAREL	EPA's National Air and Radiation Environmental Laboratory, Montgomery, AL
NHSRC	EPA's National Homeland Security Research Center, Cincinnati, OH
NIST	National Institute of Standards and Technology
NRC	U.S. Nuclear Regulatory Commission

ORIA.....U.S. EPA Office of Indoor Air and Radiation
 ϕ_{MR}required relative method uncertainty
pCi.....picocurie (10^{-9} curie)
PPE.....personal protective equipment
ppmparts per million
QA.....quality assurance
QAPPquality assurance project plan
QC.....quality control
RDDradiological dispersal device
RFAresponsible federal agencies
ROI.....region of interest
SDWA.....Safe Drinking Water Act
ssecond
STS.....sample test source
 u_{MR} required method uncertainty
 μg microgram (10^{-6} gram)
 μm micrometer (10^{-6} meter)
 μL microliter (10^{-6} liter)
WCS.....working calibration source
y.....year

Radiometric and General Unit Conversions

To Convert	To	Multiply by	To Convert	To	Multiply by
years (y)	seconds (s)	3.16×10^7	s	y	3.17×10^{-8}
	minutes (min)	5.26×10^5	min		1.90×10^{-6}
	hours (h)	8.77×10^3	h		1.14×10^{-4}
	days (d)	3.65×10^2	d		2.74×10^{-3}
disintegrations per second (dps)	becquerels (Bq)	1	Bq	dps	1
Bq	picocuries (pCi)	27.0	pCi	Bq	3.70×10^{-2}
Bq/kg	pCi/g	2.70×10^{-2}	pCi/g	Bq/kg	37.0
Bq/m ³	pCi/L	2.70×10^{-2}	pCi/L	Bq/m ³	37.0
Bq/m ³	Bq/L	10^{-3}	Bq/L	Bq/m ³	10^3
microcuries per milliliter (μCi/mL)	pCi/L	10^9	pCi/L	μCi/mL	10^{-9}
disintegrations per minute (dpm)	μCi	4.50×10^{-7}	pCi	dpm	2.22
	pCi	4.50×10^{-1}	μCi		2.22×10^6
cubic feet (ft ³)	cubic meters (m ³)	2.83×10^{-2}	m ³	ft ³	35.3
gallons (gal)	liters (L)	3.78	L	gal	0.264
gray (Gy)	rad	10^2	rad	Gy	10^{-2}
roentgen equivalent man (rem)	sievert (Sv)	10^{-2}	Sv	rem	10^2

NOTE: Traditional units are used throughout this document instead of the International System of Units (SI). Conversion to SI units will be aided by the unit conversions in this table.

www.epa.gov
February 2010
Revision 0

Rapid Radiochemical Method for Americium-241 in Water for Environmental Restoration Following Homeland Security Events

U.S. Environmental Protection Agency

**Office of Air and Radiation
Office of Radiation and Indoor Air
National Air and Radiation Environmental Laboratory
Montgomery, AL 36115**

**Office of Research and Development
National Homeland Security Research Center
Cincinnati, OH 45268**

**AMERICIUM-241 IN WATER:
RAPID METHOD FOR HIGH-ACTIVITY SAMPLES**

1. Scope and Application

- 1.1. The method will be applicable to samples where radioactive contamination is either from known or unknown origins. If any filtration of the sample is performed prior to starting the analysis, those solids should be analyzed separately. The results from the analysis of these solids should be reported separately (as a suspended activity concentration for the water volume filtered), but identified with the filtrate results.
- 1.2. The method is specific for ^{241}Am in drinking water and other aqueous samples. However, if any isotopes of curium are present in the sample, they will be carried with americium during the analytical separation process and will be observed in the final alpha spectrum.
- 1.3. The method uses rapid radiochemical separation techniques for determining americium in water samples following a radiological or nuclear incident. Although the method can detect concentrations of ^{241}Am on the same order of magnitude as methods used for the Safe Drinking Water Act (SDWA), the method is not a substitute for SDWA-approved methods for ^{241}Am .
- 1.4. The method is capable of achieving a required method uncertainty for ^{241}Am of 1.9 pCi/L at an analytical action level of 15 pCi/L. To attain the stated measurement quality objectives (MQOs) (see Sections 9.3 and 9.4), a sample volume of approximately 200 mL and count time of at least 1 hour are recommended. The sample turnaround time and throughput may vary based on additional project MQOs, the time for analysis of the final counting form, and initial sample volume. The method must be validated prior to use following the protocols provided in *Method Validation Guide for Qualifying Methods Used by Radiological Laboratories Participating in Incident Response Activities* (EPA 2009, reference 16.5).
- 1.5. The method is intended to be used for water samples that are similar in composition to drinking water. The rapid ^{241}Am method was evaluated following the guidance presented for “Level E Method Validation: Adapted or Newly Developed Methods, Including Rapid Methods” in *Method Validation Guide for Qualifying Methods Used by Radiological Laboratories Participating in Incident Response Activities* (EPA 2009, reference 16.5) and Chapter 6 of *Multi-Agency Radiological Laboratory Analytical Protocols Manual* (MARLAP 2004, reference 16.6). The matrix used for the determination of ^{241}Am was drinking water from Atlanta, GA. See the appendix for a listing of the chemical constituents of the water.
- 1.6. Multi-radionuclide analysis using sequential separation may be possible using this method in conjunction with other rapid methods.
- 1.7. The method is applicable to the determination of soluble ^{241}Am . The method is not applicable to the determination of ^{241}Am in highly insoluble particulate matter possibly present in water samples contaminated as a result of a radiological dispersion device (RDD) event.

2. Summary of Method

- 2.1. The method is based on a sequence of two chromatographic extraction resins used to concentrate, isolate, and purify americium by removing interfering radionuclides as

well as other components of the water matrix in order to prepare the americium fraction for counting by alpha spectrometry. The method utilizes vacuum-assisted flow to improve the speed of the separations. Prior to the use of the extraction resins, the water sample is filtered as necessary to remove any insoluble fractions, equilibrated with ^{243}Am tracer, and concentrated by evaporation or calcium phosphate precipitation. The sample test source (STS) is prepared by microprecipitation with NdF_3 . Standard laboratory protocol for the use of an alpha spectrometer should be used when the sample is ready for counting.

3. Definitions, Abbreviations, and Acronyms

- 3.1. Analytical Protocol Specifications (APS). The output of a directed planning process that contains the project's analytical data needs and requirements in an organized, concise form.
- 3.2. Analytical Action Level (AAL). The term "analytical action level" is used to denote the value of a quantity that will cause the decisionmaker to choose one of the alternative actions.
- 3.3. Analytical Decision Level (ADL). The analytical decision level refers to the value that is less than the AAL and based on the acceptable error rate and the required method uncertainty.
- 3.4. Discrete Radioactive Particles (DRPs or Hot Particles). Particulate matter in a sample of any matrix where a high concentration of radioactive material is contained in a tiny particle (μm range).
- 3.5. *Multi-Agency Radiological Laboratory Analytical Protocols Manual* (See Reference 16.6.).
- 3.6. Measurement Quality Objective (MQO). MQOs are the analytical data requirements of the data quality objectives and are project- or program-specific. They can be quantitative or qualitative. MQOs serve as measurement performance criteria or objectives of the analytical process.
- 3.7. Radiological Dispersal Device (RDD), i.e., a "dirty bomb." This is an unconventional weapon constructed to distribute radioactive material(s) into the environment either by incorporating them into a conventional bomb or by using sprays, canisters, or manual dispersal.
- 3.8. Required Method Uncertainty (u_{MR}). The required method uncertainty is a target value for the individual measurement uncertainties, and is an estimate of uncertainty (of measurement) before the sample is actually measured. The required method uncertainty is applicable below an AAL.
- 3.9. Required Relative Method Uncertainty (ϕ_{MR}). The required relative method uncertainty is the u_{MR} divided by the AAL and typically expressed as a percentage. It is applicable above the AAL.
- 3.10. Sample Test Source (STS). This is the final form of the sample that is used for nuclear counting. This form is usually specific for the nuclear counting technique used in the method, such as a solid deposited on a filter for alpha spectrometry analysis.

4. Interferences

- 4.1. Radiological: Alpha-emitting radionuclides with irresolvable alpha energies, such as ^{241}Am (5.48 MeV), ^{238}Pu (5.50 MeV), and ^{228}Th (5.42 MeV), must be chemically

separated to enable radionuclide-specific measurements. This method separates these radionuclides effectively. The significance of peak overlap will be determined by the individual detector's alpha energy resolution characteristics and the quality of the final precipitate that is counted.

- 4.2. Non-Radiological: Very high levels of competing higher valence anions (greater than divalent such as phosphates) will lead to lower yields when using the evaporation option due to competition with active sites on the resin. If higher valence anions are present, the phosphate precipitation option may need to be used initially in place of evaporation. If calcium phosphate coprecipitation is performed to collect americium (and other potentially present actinides) from large-volume samples, the amount of phosphate added to coprecipitate the actinides (in Step 11.1.4.3) should be reduced to accommodate the sample's high phosphate concentration.

5. Safety

5.1. General

- 5.1.1. Refer to your safety manual for concerns of contamination control, personal exposure monitoring and radiation dose monitoring.
- 5.1.2. Refer to the laboratory chemical hygiene plan (or equivalent) for general safety rules regarding chemicals in the workplace.

5.2. Radiological

5.2.1. Hot Particles (DRPs)

- 5.2.1.1. Hot particles, also termed "discrete radioactive particles" (DRPs), will be small, on the order of 1 mm or less. Typically, DRPs are not evenly distributed in the media and their radiation emissions are not uniform in all directions (anisotropic). Filtration using a 0.45- μ m or finer filter will minimize the presence of these particles.
- 5.2.1.2. Care should be taken to provide suitable containment for filter media used in the pretreatment of samples that may have DRPs, because the particles become highly statically charged as they dry out and will "jump" to other surfaces causing contamination.
- 5.2.1.3. Filter media should be individually surveyed for the presence of these particles, and this information should be reported with the final sample results.

- 5.2.2. For samples with detectable activity concentrations of this radionuclide, labware should be used only once due to potential for cross contamination.

5.3. Procedure-Specific Non-Radiological Hazards

Particular attention should be paid to the use of hydrofluoric acid (HF). HF is an extremely dangerous chemical used in the preparation of some of the reagents and in the microprecipitation procedure. Appropriate personal protective equipment (PPE) must be used in strict accordance with the laboratory safety program specification.

6. Equipment and Supplies

- 6.1. Analytical balance with a 0.01-g readability or better.
- 6.2. Cartridge reservoirs, 10- or 20-mL syringe style with locking device, or equivalent.
- 6.3. Centrifuge able to accommodate 250-mL flasks.

- 6.4. Centrifuge flasks, 250-mL capacity.
- 6.5. Filter with 0.45- μ m membrane.
- 6.6. Filter apparatus with 25-mm-diameter polysulfone filtration chimney, stem support, and stainless steel support. A single-use (disposable) filter funnel/filter combination may be used, to avoid cross-contamination.
- 6.7. 25-mm polypropylene filter, 0.1- μ m pore size, or equivalent.
- 6.8. Stainless steel planchets or other sample mounts able to hold the 25 mm filter.
- 6.9. Tweezers.
- 6.10. 100- μ L pipette or equivalent and appropriate plastic tips.
- 6.11. 10-mL plastic culture tubes with caps.
- 6.12. Tips, white inner, Eichrom part number AC-1000-IT, or equivalent.
- 6.13. Tips, yellow outer, Eichrom part number AC-1000-OT, or equivalent.
- 6.14. Vacuum box, such as Eichrom part number AC-24-BOX, or equivalent.
- 6.15. Vortex mixer.
- 6.16. Vacuum pump or laboratory vacuum system.
- 6.17. Miscellaneous laboratory ware, plastic or glass, 250 mL and 350 mL.

7. Reagents and Standards

Note: All reagents are American Chemical Society (ACS) reagent grade or equivalent unless otherwise specified.

Note: Unless otherwise indicated, all references to laboratory water should be understood to mean Type I Reagent water. All solutions used in microprecipitation should be prepared with water filtered through a 0.45- μ m (or better) filter.

- 7.1. Am-243 tracer solution: 6–10 dpm of ^{243}Am per aliquant, activity added known to at least 5% (combined standard uncertainty $\leq 5\%$).
- 7.2. Ammonium hydrogen phosphate (3.2 M): Dissolve 106 g of ammonium hydrogen phosphate ($(\text{NH}_4)_2\text{HPO}_4$) in 200 mL of water, heat gently to dissolve, and dilute to 250 mL with water.
- 7.3. Ammonium hydroxide (15 M): Concentrated NH_4OH , available commercially.
- 7.4. Ammonium thiocyanate indicator (1 M): Dissolve 7.6 g of ammonium thiocyanate (NH_4SCN) in 90 mL of water and dilute to 100 mL with water. An appropriate quantity of sodium thiocyanate (8.1 g) or potassium thiocyanate (9.7 g) may be substituted for ammonium thiocyanate.
- 7.5. Ascorbic acid (1 M): Dissolve 17.6 g of ascorbic acid ($\text{C}_6\text{H}_8\text{O}_6$) in 90 mL of water and dilute to 100 mL with water. Prepare weekly.
- 7.6. Calcium nitrate (0.9 M): Dissolve 53 g of calcium nitrate tetrahydrate ($\text{Ca}(\text{NO}_3)_2 \cdot 4\text{H}_2\text{O}$) in 100 mL of water and dilute to 250 mL with water.
- 7.7. Ethanol, 100%: Anhydrous $\text{C}_2\text{H}_5\text{OH}$, available commercially.
 - 7.7.1. Ethanol (~80% v/v): Mix 80 mL 100% ethanol and 20 mL water.
- 7.8. Ferrous sulfamate (0.6 M): Add 57 g of sulfamic acid ($\text{NH}_2\text{SO}_3\text{H}$) to 150 mL of water, heat to 70°C. Slowly add 7 g of iron powder (< 100 mesh size) while heating and stirring with a magnetic stirrer until dissolved (may take as long as two hours). Filter the hot solution using a qualitative filter, transfer to flask, and dilute to 200 mL with water. Prepare fresh weekly.

- 7.9. Hydrochloric acid (12 M): Concentrated HCl, available commercially.
 - 7.9.1. Hydrochloric acid (9 M): Add 750 mL of concentrated HCl to 100 mL of water and dilute to 1 L with water.
 - 7.9.2. Hydrochloric acid (4 M): Add 333 mL of concentrated HCl to 500 mL of water and dilute to 1 L with water.
 - 7.9.3. Hydrochloric acid (1 M): Add 83 mL of concentrated HCl to 500 mL of water and dilute to 1 L with water.
 - 7.10. Hydrofluoric acid (28 M): Concentrated HF, available commercially.
 - 7.10.1. Hydrofluoric acid (0.58 M): Add 20 mL of concentrated HF to 980 mL of filtered demineralized water and mix. Store in a plastic bottle.
 - 7.11. Neodymium standard solution (1000 µg/mL): May be purchased from a supplier of standards for atomic spectroscopy.
 - 7.12. Neodymium carrier solution (0.50 mg/mL): Dilute 10 mL of the neodymium standard solution (7.11) to 20.0 mL with filtered demineralized water. This solution is stable.
 - 7.13. Neodymium fluoride substrate solution (10 µg/mL): Pipette 5 mL of neodymium standard solution (7.11) into a 500-mL plastic bottle. Add 460 mL of 1-M HCl to the plastic bottle. Cap the bottle and shake to mix. Measure 40 mL of concentrated HF in a plastic graduated cylinder and add to the bottle. Recap the bottle and shake to mix thoroughly. This solution is stable for up to six months.
 - 7.14. Nitric acid (16 M): Concentrated HNO₃, available commercially.
 - 7.14.1. Nitric acid (3 M): Add 191 mL of concentrated HNO₃ to 700 mL of water and dilute to 1 L with water.
 - 7.14.2. Nitric acid (2 M): Add 127 mL of concentrated HNO₃ to 800 mL of water and dilute to 1 L with water.
 - 7.14.3. Nitric acid (0.5 M): Add 32 mL of concentrated HNO₃ to 900 mL of water and dilute to 1 L with water.
 - 7.15. Nitric acid (2M) – sodium nitrite (0.1 M) solution: Add 32 mL of concentrated HNO₃ (7.14) to 200 mL of water and mix. Dissolve 1.7 g of sodium nitrite (NaNO₂) in the solution and dilute to 250 mL with water. Prepare fresh daily.
 - 7.16. Nitric acid (3 M) – aluminum nitrate (1.0M) solution: Dissolve 213 g of anhydrous aluminum nitrate (Al(NO₃)₃) in 700 mL of water. Add 190 mL of concentrated HNO₃ (7.14) and dilute to 1 L with water. An appropriate quantity of aluminum nitrate nonahydrate (375 g) may be substituted for anhydrous aluminum nitrate.
 - 7.17. Phenolphthalein solution: Dissolve 1 g of phenolphthalein in 100 mL 95% isopropyl alcohol and dilute with 100 mL of water.
 - 7.18. TRU Resin: 2-mL cartridge, 50- to 100-µm mesh size, Eichrom part number TR-R50-S and TR-R200-S, or equivalent.
 - 7.19. UTEVA Resin: 2-mL cartridge, 50- to 100-µm mesh size, Eichrom part number UT-R50-S and UT-R200-S, or equivalent.
8. Sample Collection, Preservation, and Storage
 - 8.1. No sample preservation is required if sample is delivered to the laboratory within 3 days of sampling date/time.
 - 8.2. If the dissolved concentration of americium is sought, the insoluble fraction must be removed by filtration before preserving with acid.

- 8.3. If the sample is to be held for more than 3 days, concentrated HNO₃ shall be added to achieve a pH<2.

9. Quality Control

- 9.1. Batch quality control results shall be evaluated and meet applicable Analytical Project Specifications (APS) prior to release of unqualified data. In the absence of project-defined APS or a project-specific quality assurance project plan (QAPP), the quality control sample acceptance criteria defined in the laboratory quality manual and procedures shall be used to determine acceptable performance for this method.
 - 9.1.1. A laboratory control sample (LCS) shall be run with each batch of samples. The concentration of the LCS shall be at or near the action level or level of interest for the project.
 - 9.1.2. One method blank shall be run with each batch of samples. The laboratory blank should consist of laboratory water.
 - 9.1.3. One laboratory duplicate shall be run with each batch of samples. The laboratory duplicate is prepared by removing an aliquant from the original sample container.
 - 9.1.4. A matrix spike sample may be included as a batch quality control sample if there is concern that matrix interferences may compromise chemical yield measurements or overall data quality.
- 9.2. The source preparation method should produce a sample test source whose spectrum shows the full width at half maximum (FWHM) of ~60-80 keV for each peak in the spectrum. Precipitate reprocessing should be considered if this range of FWHM cannot be achieved.
- 9.3. This method is capable of achieving a u_{MR} of 1.9 pCi/L at or below an action level of 15 pCi/L. This may be adjusted in the event specific MQOs are different.
- 9.4. This method is capable of achieving a ϕ_{MR} 13% above 15 pCi/L. This may be adjusted if the event specific MQOs are different.
- 9.5. This method is capable of achieving a required minimum detectable concentration (MDC) of 1.5 pCi/L.

10. Calibration and Standardization

- 10.1. Set up the alpha spectrometry system according to the manufacturer's recommendations. The energy range of the spectrometry system should at least include the region between 3 and 8 MeV.
- 10.2. Calibrate each detector used to count samples according to ASTM Standard Practice D7282, Section 18, "Alpha Spectrometry Instrument Calibrations" (see Reference 16.3).
- 10.3. Continuing Instrument Quality Control Testing shall be performed according to ASTM Standard Practice D7282, Sections 20, 21, and 24.

11. Procedure

- 11.1. Water Sample Preparation
 - 11.1.1. As required, filter the 100- to 200-mL sample aliquant through a 0.45- μ m filter and collect the sample in an appropriate size beaker.

- 11.1.2. Acidify the sample with concentrated HNO₃ to a pH of less than 2.0 by adding enough HNO₃. This usually requires about 2 mL of HNO₃ per 1000 mL of sample.
- 11.1.3. Add 6-10 dpm of ²⁴³Am as a tracer, following laboratory protocol.

Note: For a sample approximately 100 mL or less, the evaporation option is recommended. Proceed to Step 11.1.5. Otherwise, go to Step 11.1.4.

- 11.1.4. Calcium phosphate coprecipitation option
 - 11.1.4.1. Add 0.5 mL of 0.9-M Ca(NO₃)₂ to each beaker. Place each beaker on a hot plate, cover with a watch glass, and heat until boiling.
 - 11.1.4.2. Once the sample boils, take the watch glass off the beaker and lower the heat.
 - 11.1.4.3. Add 2–3 drops of phenolphthalein indicator and 200 µL of 3.2 M (NH₄)₂HPO₄ solution.
 - 11.1.4.4. Add enough concentrated NH₄OH with a squeeze bottle to reach the phenolphthalein end point and form Ca₃(PO₄)₂ precipitate. NH₄OH should be added very slowly. Stir the solution with a glass rod. Allow the sample to heat gently to digest the precipitate for another 20-30 minutes.
 - 11.1.4.5. If the sample volume is too large to centrifuge the entire sample, allow precipitate to settle until solution can be decanted (30 minutes to 2 hours) and go to Step 11.1.4.7.
 - 11.1.4.6. If the volume is small enough to centrifuge, go to Step 11.1.4.8.
 - 11.1.4.7. Decant supernatant solution and discard to waste.
 - 11.1.4.8. Transfer the precipitate to a 250-mL centrifuge tube, completing the transfer with a few milliliters of water, and centrifuging the precipitate for approximately 10 minutes at 2000 rpm.
 - 11.1.4.9. Decant supernatant solution and discard to waste.
 - 11.1.4.10. Wash the precipitate with an amount of water approximately twice the volume of the precipitate. Mix well using a stirring rod, breaking up the precipitate if necessary. Centrifuge for 5–10 minutes at 2000 rpm. Discard the supernatant solution.
 - 11.1.4.11. Dissolve precipitate in approximately 5 mL concentrated HNO₃. Transfer solution to a 100-mL beaker. Rinse centrifuge tube with 2–3 mL of concentrated HNO₃ and transfer to the same beaker. Evaporate solution to dryness and go to Step 11.2.
- 11.1.5. Evaporation option to reduce volume and to digest organic components
 - 11.1.5.1. Evaporate sample to less than 50 mL and transfer to a 100-mL beaker.

Note: For some water samples, CaSO₄ formation may occur during evaporation. If this occurs, use the Ca₃(PO₄)₂ precipitation option in Step 11.1.4.

- 11.1.5.2. Gently evaporate the sample to dryness and redissolve in approximately 5 mL of concentrated HNO₃.
- 11.1.5.3. Repeat Step 11.1.5.2 two more times, evaporate to dryness, and go to Step 11.2.
- 11.2. Actinide Separations Using Eichrom Resins
 - 11.2.1. Redissolve Ca₃(PO₄)₂ residue or evaporated water sample
 - 11.2.1.1. Dissolve either residue with 10 mL of 3-M HNO₃ - 1.0-M Al(NO₃)₃.

Note: An additional 5 mL may be necessary if the residue volume is large.
 - 11.2.1.2. Add 2 mL of 0.6-M ferrous sulfamate to each solution. Swirl to mix.

Note: If the additional 5 mL was used to dissolve the sample in Step 11.2.1.1, add a total of 3 mL of ferrous sulfamate solution.
 - 11.2.1.3. Add 1 drop of 1-M ammonium thiocyanate indicator to each sample and mix.

Note: The color of the solution turns deep red, due to the presence of soluble ferric thiocyanate complex.
 - 11.2.1.4. Add 1 mL of 1-M ascorbic acid to each solution, swirling to mix. Wait for 2–3 minutes.

Note: The red color should disappear, which indicates reduction of Fe⁺³ to Fe⁺². If the red color still persists, then additional ascorbic acid solution has to be added drop-wise with mixing until the red color disappears.

Note: If particles are observed suspended in the solution, centrifuge the sample. The supernatant solution will be transferred to the column in Step 11.2.3.1. The precipitates will be discarded.
 - 11.2.2. Setup of UTEVA and TRU cartridges in tandem on the vacuum box system

Note: Steps 11.2.2.1 to 11.2.2.5 deal with a commercially available filtration system. Other vacuum systems developed by individual laboratories may be substituted here as long as the laboratory has provided guidance to analysts in their use.

 - 11.2.2.1. Place the inner tube rack (supplied with vacuum box) into the vacuum box with the centrifuge tubes in the rack. Fit the lid to the vacuum system box.
 - 11.2.2.2. Place the yellow outer tips into all 24 openings of the lid of the vacuum box. Fit in the inner white tip into each yellow tip.
 - 11.2.2.3. For each sample solution, fit in a TRU cartridge on to the inner white tip. Ensure the UTEVA cartridge is locked into the top end of the TRU cartridge.

- 11.2.2.4. Lock syringe barrels (funnels/reservoirs) to the top end of the UTEVA cartridge.
- 11.2.2.5. Connect the vacuum pump to the box. Turn the vacuum pump on and ensure proper fitting of the lid.

IMPORTANT: The unused openings on the vacuum box should be sealed. Yellow caps (included with the vacuum box) can be used to plug unused white tips to achieve good seal during the separation.

- 11.2.2.6. Add 5 mL of 3-M HNO₃ to the funnel to precondition the UTEVA and TRU cartridges.
- 11.2.2.7. Adjust the vacuum pressure to achieve a flow-rate of ~1 mL/min.

IMPORTANT: Unless otherwise specified in the procedure, use a flow rate of ~1 mL/min for load and strip solutions and ~3 mL/min for rinse solutions.

- 11.2.3. Preliminary purification of the americium fraction using UTEVA and TRU resins
 - 11.2.3.1. Transfer each solution from Step 11.2.1.4 into the appropriate funnel by pouring or by using a plastic transfer pipette. Allow solution to pass through both cartridges at a flow rate of ~1 mL/min.
 - 11.2.3.2. Add 5 mL of 3-M HNO₃ to each beaker (from Step 11.2.1.4) as a rinse and transfer each solution into the appropriate funnel (the flow rate can be adjusted to ~3 mL/min).
 - 11.2.3.3. Add 5 mL of 3-M HNO₃ into each funnel as a second column rinse (flow rate ~3 mL/min).
 - 11.2.3.4. Separate UTEVA cartridge from TRU cartridge. Discard UTEVA cartridge and the effluent collected so far. Place new funnel on the TRU cartridge.
- 11.2.4. Final americium separation using TRU cartridge

Note: Steps 11.2.4.1 to 11.2.4.3 may be omitted if the samples are known not to contain plutonium

- 11.2.4.1. Pipette 5 mL of 2-M HNO₃ into each TRU cartridge from Step 11.2.3.4. Allow to drain.
- 11.2.4.2. Pipette 5 mL of 2-M HNO₃ - 0.1-M NaNO₂ directly into each cartridge, rinsing each cartridge reservoir while adding the 2-M HNO₃ - 0.1-M NaNO₂.

IMPORTANT: The flow rate for the cartridge should be adjusted to ~1 mL/min for this step.

Note: Sodium nitrite is used to oxidize any Pu⁺³ to Pu⁺⁴ and enhance the Pu/Am separation.

- 11.2.4.3. Allow the rinse solution to drain through each cartridge.
- 11.2.4.4. Add 5 mL of 0.5-M HNO₃ to each cartridge and allow it to drain.

Note: 0.5-M HNO₃ is used to lower the nitrate concentration prior to conversion to the chloride system.

- 11.2.4.5. Discard the load and rinse solutions to waste.
- 11.2.4.6. Ensure that clean, labeled tubes (at least 25-mL capacity) are placed in the tube rack.
- 11.2.4.7. Add 3 mL of 9-M HCl to each cartridge to convert to chloride system. Collect eluate.
- 11.2.4.8. Add 20 mL of 4-M HCl to elute americium. Collect eluate in the same tube.
- 11.2.4.9. Transfer the combined eluates from Steps 11.2.4.7 and 11.2.4.8 to a 50-mL beaker.
- 11.2.4.10. Rinse tube with a few milliliters of water and add to the same beaker.
- 11.2.4.11. Evaporate samples to near dryness.

Important: Do not bake the residue.

- 11.2.4.12. Allow the beaker to cool slightly and then add a few drops of concentrated HCl followed by 1 mL of water.
- 11.2.4.13. Transfer the solution from Step 11.2.4.12 to a 10-mL plastic culture tube. Wash the original sample vessel twice with 1-mL washes of 1M HCl. Transfer the washings to the culture tube. Mix by gently swirling the solution in the tube.
- 11.2.4.14. Proceed to neodymium fluoride microprecipitation in Step 11.3.
- 11.2.4.15. Discard the TRU cartridge.

11.3. Preparation of the Sample Test Source

Note: Instructions below describe preparation of a single Sample Test Source. Several STSs can be prepared simultaneously if a multi-channel vacuum box (whale apparatus) is available.

- 11.3.1. Add 100 µL of the neodymium carrier solution to the tube from Step 11.2.4.14 with a micropipette. Gently swirl the tube to mix the solution.
- 11.3.2. Add 10 drops (0.5 mL) of concentrated HF to the tube and mix well by gentle swirling.
- 11.3.3. Cap the tube and place it in a cold-water bath for at least 30 minutes.
- 11.3.4. Insert the polysulfone filter stem in the 250-mL vacuum flask. Place the stainless steel screen on top of the fitted plastic filter stem.
- 11.3.5. Place a 25-mm polymeric filter face up on the stainless steel screen. Center the filter on the stainless steel screen support and apply vacuum. Wet the filter with 100% ethanol, followed by filtered Type I water.

Caution: There is no visible difference between the two sides of the filter. If the filter is turned over accidentally, it is recommended that the filter be discarded and a fresh one removed from the container.

- 11.3.6. Lock the filter chimney firmly in place on the filter screen and wash the filter with additional filtered Type I water.
- 11.3.7. Pour 5.0 mL of neodymium substrate solution down the side of the filter chimney, avoiding directing the stream at the filter. When the solution passes through the filter, wait at least 15 seconds before the next step.
- 11.3.8. Repeat Step 11.3.7 with an additional 5.0 mL of the substrate solution.
- 11.3.9. Pour the sample from Step 11.3.3 down the side of the filter chimney and allow the vacuum to draw the solution through.
- 11.3.10. Rinse the tube twice with 2 mL of 0.58 M HF, stirring each wash briefly using a vortex mixer, and pouring each wash down the side of the filter chimney.
- 11.3.11. Repeat rinse using 2 mL of filtered Type I water once.
- 11.3.12. Repeat rinse using 2 mL of 80% ethyl alcohol once.

Note: Steps 11.3.10 and 11.3.12 were shown to improve the FWHM in the alpha spectrum, providing more consistent peak resolution.

- 11.3.13. Wash any drops remaining on the sides of the chimney down toward the filter with a few milliliters of 80% ethyl alcohol.

Caution: Directing a stream of liquid onto the filter will disturb the distribution of the precipitate on the filter and render the sample unsuitable for α -spectrometry resolution.

- 11.3.14. Without turning off the vacuum, remove the filter chimney.
- 11.3.15. Turn off the vacuum to remove the filter. Discard the filtrate to waste for future disposal. If the filtrate is to be retained, it should be placed in a plastic container to avoid dissolution of the glass vessel by dilute HF.
- 11.3.16. Place the filter on a properly labeled mounting disc. Secure with a mounting ring or other device that will render the filter flat for counting.
- 11.3.17. Let the sample air-dry for a few minutes and when dry, place in a container suitable for transfer and submit for counting.

Note: Other methods for STS preparation, such as electroplating or microprecipitation with cerium fluoride, may be used in lieu of the neodymium fluoride microprecipitation, but any such substitution must be validated as described in Section 1.4.

12. Data Analysis and Calculations

- 12.1. Equation for determination of final result, combined standard uncertainty, and radiochemical yield (if requested):

The activity concentration of an analyte and its combined standard uncertainty are calculated using the following equations:

$$AC_a = \frac{A_t \times R_a \times D_t \times I_t}{V_a \times R_t \times D_a \times I_a}$$

and

$$u_c(AC_a) = \sqrt{u^2(R_a) \times \frac{A_t^2 \times D_t^2 \times I_t^2}{V_a^2 \times R_t^2 \times D_a^2 \times I_a^2} + AC_a^2 \times \left(\frac{u^2(A_t)}{A_t^2} + \frac{u^2(V_a)}{V_a^2} + \frac{u^2(R_t)}{R_t^2} \right)}$$

where:

- AC_a = activity concentration of the analyte at time of count, (pCi/L)
- A_t = activity of the tracer added to the sample aliquant at its reference date/time, (pCi)
- R_a = net count rate of the analyte in the defined region of interest (ROI), in counts per second
- R_t = net count rate of the tracer in the defined ROI, in counts per second
- V_a = volume of the sample aliquant, (L)
- D_t = correction factor for decay of the tracer from its reference date and time to the midpoint of the counting period
- D_a = correction factor for decay of the analyte from the time of sample collection (or other reference time) to the midpoint of the counting period, if required
- I_t = probability of α emission in the defined ROI per decay of the tracer (Table 17.1)
- I_a = probability of α emission in the defined ROI per decay of the analyte (Table 17.1)
- $u_c(AC_a)$ = combined standard uncertainty of the activity concentration of the analyte (pCi/L)
- $u(A_t)$ = standard uncertainty of the activity of the tracer added to the sample (pCi)
- $u(V_a)$ = standard uncertainty of the volume of sample aliquant (L)
- $u(R_a)$ = standard uncertainty of the net count rate of the analyte in counts per second
- $u(R_t)$ = standard uncertainty of the net count rate of the tracer in counts per second

Note: The uncertainties of the decay-correction factors and of the probability of decay factors are assumed to be negligible.

Note: The equation for the combined standard uncertainty ($u_c(AC_a)$) calculation is arranged to eliminate the possibility of dividing by zero if $R_a = 0$.

Note: The standard uncertainty of the activity of the tracer added to the sample must reflect that associated with the activity of the standard reference material and any other significant sources of uncertainty such as those introduced during the preparation of the tracer solution (e.g., weighing or dilution factors) and during the process of adding the tracer to the sample.

Note: The alpha spectrum of americium isotopes should be examined carefully and the ROI reset manually, if necessary, to minimize the spillover of ^{241}Am peak into the ^{243}Am peak.

12.1.1. The net count rate of an analyte or tracer and its standard uncertainty can be calculated using the following equations:

$$R_x = \frac{C_x}{t_s} - \frac{C_{bx}}{t_b}$$

and

$$u(R_x) = \sqrt{\frac{C_x + 1}{t_s^2} + \frac{C_{bx} + 1}{t_b^2}}$$

where:

R_x	=	net count rate of analyte or tracer, in counts per second
C_x	=	sample counts in the analyte or the tracer ROI
t_s	=	sample count time (s)
C_{bx}	=	background counts in the same ROI as for x
t_b	=	background count time (s)
$u(R_x)$	=	standard uncertainty of the net count rate of tracer or analyte, in counts per second ¹

If the radiochemical yield of the tracer is requested, the yield and its combined standard uncertainty can be calculated using the following equations:

$$RY = \frac{R_t}{0.037 \times A_t \times D_t \times I_t \times \varepsilon}$$

and

$$u(RY) = RY \times \sqrt{\frac{u^2(R_t)}{R_t^2} + \frac{u^2(A_t)}{A_t^2} + \frac{u^2(\varepsilon)}{\varepsilon^2}}$$

where:

RY	=	radiochemical yield of the tracer, expressed as a fraction
R_t	=	net count rate of the tracer, in counts per second
A_t	=	activity of the tracer added to the sample (pCi)
D_t	=	correction factor for decay of the tracer from its reference date and time to the midpoint of the counting period
I_t	=	probability of α emission in the defined ROI per decay of the tracer (Table 17.1)
ε	=	detector efficiency, expressed as a fraction
$u_c(RY)$	=	combined standard uncertainty of the radiochemical yield

¹ For methods with very low counts, MARLAP Section 19.5.2.2 recommends adding one count each to the gross counts and the background counts when estimating the uncertainty of the respective net counts. This minimizes negative bias in the estimate of uncertainty and protects against calculating zero uncertainty when a total of zero counts are observed for the sample and background.

- $u(R_t)$ = standard uncertainty of the net count rate of the tracer, in counts per second
- $u(A_t)$ = standard uncertainty of the activity of the tracer added to the sample (pCi)
- $u(\varepsilon)$ = standard uncertainty of the detector efficiency

12.1.2. If the critical level concentration (S_c) or the minimum detectable concentration (MDC) are requested (at an error rate of 5%), they can be calculated using the following equations:²

$$S_c = \frac{\left[0.4 \times \left(\frac{t_s}{t_b} - 1 \right) + 0.677 \times \left(1 + \frac{t_s}{t_b} \right) + 1.645 \times \sqrt{\left(R_{ba} t_b + 0.4 \right) \times \frac{t_s}{t_b} \times \left(1 + \frac{t_s}{t_b} \right)} \right] \times A_t \times D_t \times I_t}{t_s \times V_a \times R_t \times D_a \times I_a}$$

$$\text{MDC} = \frac{\left[2.71 \times \left(1 + \frac{t_s}{t_b} \right) + 3.29 \times \sqrt{R_{ba} t_s \times \left(1 + \frac{t_s}{t_b} \right)} \right] \times A_t \times D_t \times I_t}{t_s \times V_a \times R_t \times D_a \times I_a}$$

where:

- R_{ba} = background count rate for the analyte in the defined ROI, in counts per second

12.2. Results Reporting

12.2.1. The following items should be reported for each result: volume of sample used; yield of tracer and its uncertainty; and full width at half maximum (FWHM) of each peak used in the analysis.

12.2.2. The following conventions should be used for each result:

12.2.2.1. Result in scientific notation \pm combined standard uncertainty.

12.2.2.2. If solid material was filtered from the solution and analyzed separately, the results of that analysis should be reported separately as pCi/L of the original volume from which the solids were filtered if no other guidance is provided on reporting of results for the solids. For example:

²⁴¹Am for Sample 12-1-99:

Filtrate Result: 12.8 \pm 1.5 pCi/L

Filtered Residue Result: 2.5 \pm 0.3 pCi/L

² The formulations for the critical level and minimum detectable concentration are based on the Stapleton Approximation as recommended in MARLAP Section 20A.2.2, Equations 20.54 and 20A.3.2, and Equation 20.74, respectively. The formulations presented here assume an error rate of $\alpha = 0.05$, $\beta = 0.05$ (with $z_{1-\alpha} = z_{1-\beta} = 1.645$), and $d = 0.4$. For methods with very low numbers of counts, these expressions provide better estimates than do the traditional formulas for the critical level and MDC.

13. Method Performance

- 13.1. Method validation results are to be reported as an attachment.
 - 13.1.1. Expected turnaround time per batch of 14 samples plus QC, assuming microprecipitations for the whole batch are performed simultaneously using a vacuum box system:
 - 13.1.2. For an analysis of a 200-mL sample aliquant, sample preparation and digestion should take 3.5 h.
 - 13.1.3. Purification and separation of the americium fraction using cartridges and vacuum box system should take 2.5 h.
 - 13.1.4. Sample evaporation to near dryness should take ~ 30 minutes.
 - 13.1.5. The last Step of source preparation takes ~1 h.
 - 13.1.6. A 1–3 h counting time is sufficient to meet the MQOs listed in 9.3 and 9.4, assuming detector efficiency of 0.2-0.3, and radiochemical yield of at least 0.5. Longer counting time may be necessary to meet these MQOs if detector efficiency is lower.
 - 13.1.7. Data should be ready for reduction between 8.5 and 10.5 h after beginning of analysis.

- 14. Pollution Prevention: This method utilizes small volume (2-mL) extraction chromatographic resin columns. This approach leads to a significant reduction in the volumes of load, rinse and strip solutions, as compared to classical methods using ion exchange resins to separate and purify the americium fraction.

15. Waste Management

- 15.1. Types of waste generated per sample analyzed
 - 15.1.1. If $\text{Ca}_3(\text{PO}_4)_2$ coprecipitation is performed, approximately 100-1000 mL of decanted solution that is pH neutral are generated.
 - 15.1.2. Approximately 35 mL of acidic waste from loading and rinsing the two extraction columns are generated.
 - 15.1.3. Approximately 35 mL of acidic waste from microprecipitation method for source preparation, contains 1 mL of HF and ~ 8 mL ethanol.
 - 15.1.4. Unless processed further, the UTEVA cartridge may contain isotopes of uranium, neptunium, and thorium, if any of these were present in the sample originally.
 - 15.1.5. Unless processed further, the TRU cartridge may contain isotopes of plutonium if any of them were present in the sample originally.
- 15.2. Evaluate all waste streams according to disposal requirements by applicable regulations.

16. References

- 16.1. ACW03 VBS, Rev. 1.6, “Americium, Plutonium, and Uranium in Water (with Vacuum Box System),” Eichrom Technologies, Inc., Lisle, Illinois (February 2005).
- 16.2. G-03, V.1 “Microprecipitation Source Preparation for Alpha Spectrometry,” HASL-300, 28th Edition, (February 1997).

- 16.3. ASTM D7282 “Standard Practice for Set-up, Calibration, and Quality Control of Instruments Used for Radioactivity Measurements,” ASTM Book of Standards 11.02, current version, ASTM International, West Conshohocken, PA.
- 16.4. VBS01, Rev.1.3, “Setup and Operation Instructions for Eichrom’s Vacuum Box System (VBS),” Eichrom Technologies, Inc., Lisle, Illinois (January 2004).
- 16.5. U.S. Environmental Protection Agency (EPA). 2009. *Method Validation Guide for Radiological Laboratories Participating in Incident Response Activities*. Revision 0. Office of Air and Radiation, Washington, DC. EPA 402-R-09-006, June. Available at: www.epa.gov/narel/incident_guides.html.
- 16.6. *Multi-Agency Radiological Laboratory Analytical Protocols Manual (MARLAP)*. 2004. EPA 402-B-1304 04-001A, July. Volume I, Chapters 6, 7, 20, Glossary; Volume II and Volume III, Appendix G. Available at: www.epa.gov/radiation/marlap/index.html.
- 16.7. ASTM D1193, “Standard Specification for Reagent Water” ASTM Book of Standards 11.01, current version, ASTM International, West Conshohocken, PA.

17. Tables, Diagrams, Flow Charts, and Validation Data

17.1. Tables [including major radiation emissions from all radionuclides separated]

Table 17.1 Alpha Particle Energies and Abundances of Importance^[1]

Nuclide	Half-Life (Years)	λ (s^{-1})	Abundance	α Energy (MeV)
²⁴¹ Am	432.6	5.077×10^{-11}	0.848	5.486
			0.131	5.443
			0.0166	5.388
²⁴³ Am	7.37×10^3	2.98×10^{-12}	0.871	5.275
			0.112	5.233
			0.0136	5.181

^[1]Only the most abundant particle energies and abundances have been noted here.

17.2. Ingrowth Curves and Ingrowth Factors

This section intentionally left blank

17.3. Spectrum from a Processed Sample

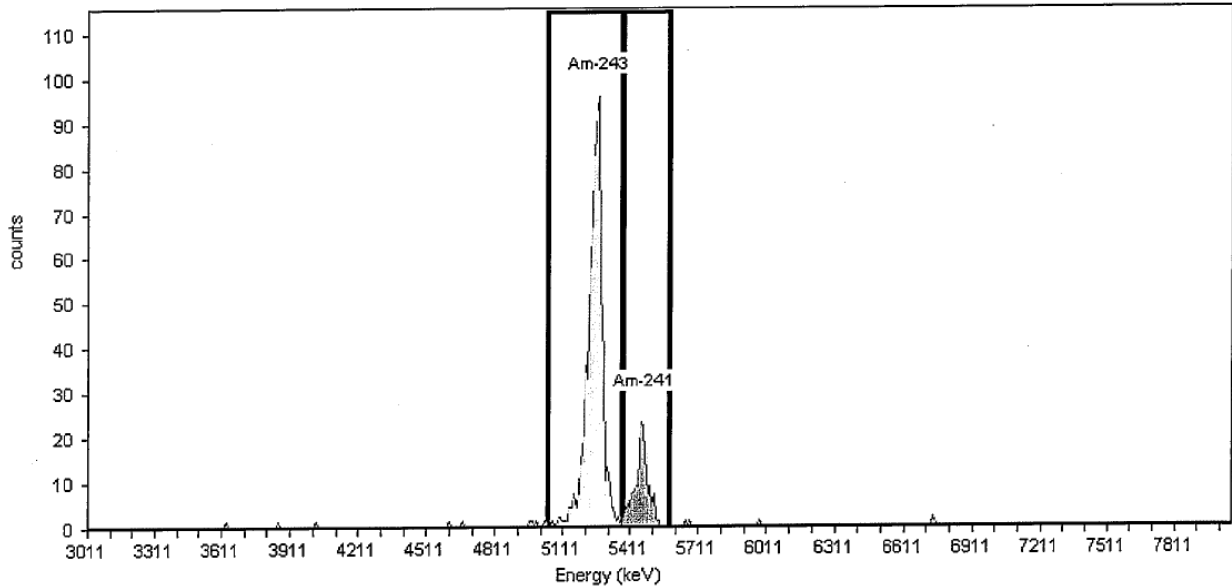

17.2 Decay Scheme

²⁴¹Am and ²⁴³Am Decay Scheme

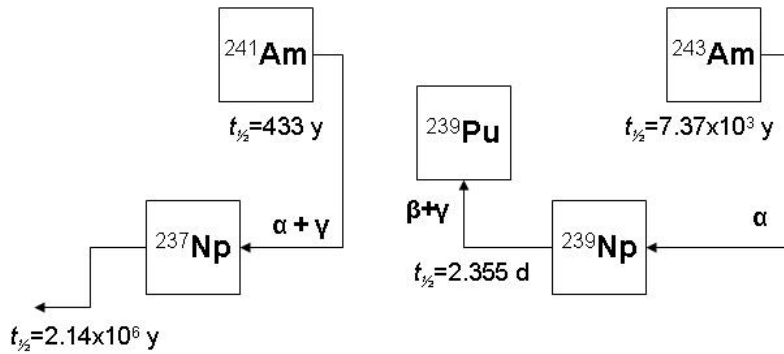

17.4. Flow Chart

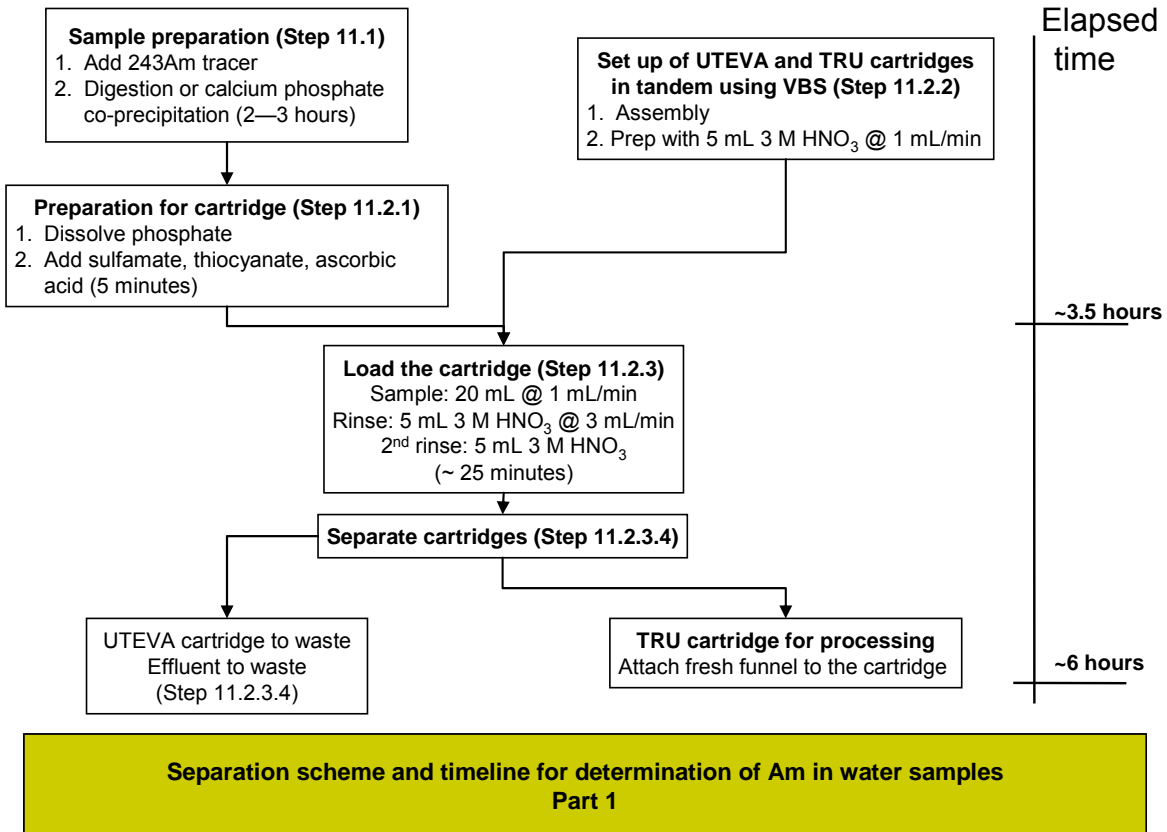

Americium-241 in Water: Rapid Method for High-Activity Samples

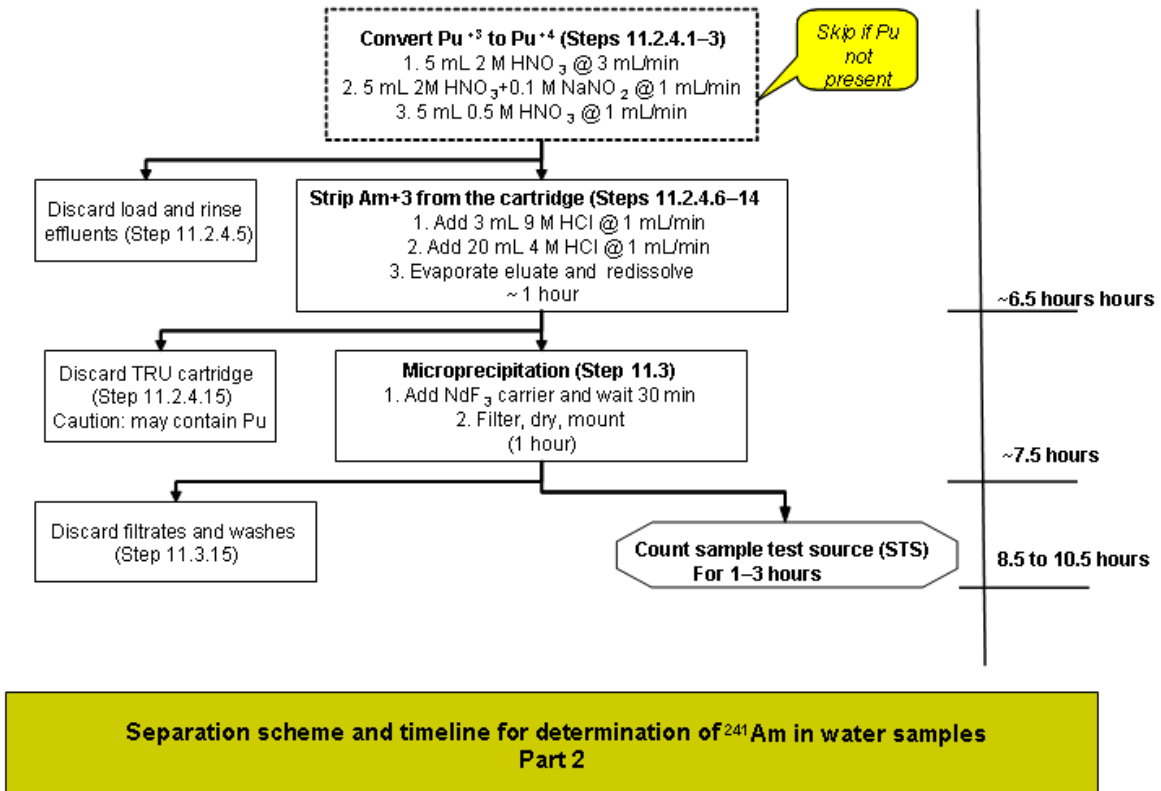

Appendix

Composition of Atlanta Drinking Water Used for this Study

Metals by ICP-AES	Concentration (mg/L)*
Silicon	3.18
Aluminum	<0.200
Barium	0.0133
Calcium	9.38
Iron	<0.100
Magnesium	<0.500
Potassium	<0.500
Sodium	<0.500
Inorganic Anions	
Chloride	12.7
Sulfate	15.6
Nitrogen, Nitrate (as N)	1.19
Carbon Dioxide	
Bicarbonate Alkalinity	23.8
Carbonate Alkalinity	<3.00
Radionuclide	Concentration (pCi/L)**
Uranium 234, 235, 238	<0.01, <0.01, <0.01
Plutonium 238, 239/240	<0.02, <0.02
Americium 241	<0.02
Strontium 90	<0.3
Radium 226***	0.11 ± 0.27 -0.30 ± 0.45

Note: Analyses conducted by independent laboratories.

- * Values below the reporting level are presented as less than (<) values. No measurement uncertainty was reported with values greater than the "Reporting Level."
- ** Reported values represent the calculated minimum detectable concentration (MDC) for the radionuclide(s).
- *** Two samples analyzed.

www.epa.gov
February 2010
Revision 0

**Rapid Radiochemical Method for
Plutonium-238 and Plutonium-239/240
in Water
for Environmental Restoration Following
Homeland Security Events**

U.S. Environmental Protection Agency

**Office of Air and Radiation
Office of Radiation and Indoor Air
National Air and Radiation Environmental Laboratory
Montgomery, AL 36115**

**Office of Research and Development
National Homeland Security Research Center
Cincinnati, OH 45268**

**PLUTONIUM-238 AND PLUTONIUM-239/240 IN WATER:
RAPID METHOD FOR HIGH-ACTIVITY SAMPLES**

1. Scope and Application

- 1.1. The method will be applicable to samples where contamination is either from known or unknown origins. If any filtration of the sample is performed prior to starting the analysis, those solids should be analyzed separately. The results from the analysis of these solids should be reported separately (as a suspended activity concentration for the water volume filtered), but identified with the filtrate results.
- 1.2. The method is specific for ^{238}Pu and $^{239/240}\text{Pu}$ in drinking water and other aqueous samples.
- 1.3. The method uses rapid radiochemical separation techniques for determining alpha-emitting plutonium isotopes in water samples following a nuclear or radiological incident. Although the method can detect concentrations of ^{238}Pu and $^{239/240}\text{Pu}$ on the same order of magnitude as methods used for the Safe Drinking Water Act (SDWA), this method is not a substitute for SDWA-approved methods for isotopic plutonium.
- 1.4. The method cannot distinguish between ^{239}Pu and ^{240}Pu and any results are reported as the total activity of the two radionuclides.
- 1.5. The method is capable of achieving a required method uncertainty for ^{238}Pu or $^{239/240}\text{Pu}$ of 1.9 pCi/L at an analytical action level of 15 pCi/L. To attain the stated measurement quality objectives (MQOs) (see Sections 9.3 and 9.4), a sample volume of approximately 200 mL and count time of at least 1 hour are recommended. The sample turnaround time and throughput may vary based on additional project MQOs, the time for analysis of the final counting form and initial sample volume. The method must be validated prior to use following the protocols provided in *Method Validation Guide for Qualifying Methods Used by Radiological Laboratories Participating in Incident Response Activities* (EPA 2009, reference 16.5).
- 1.6. The method is intended to be used for water samples that are similar in composition to drinking water. The rapid plutonium method was evaluated following the guidance presented for “Level E Method Validation: Adapted or Newly Developed Methods, Including Rapid Methods” in *Method Validation Guide for Qualifying Methods Used by Radiological Laboratories Participating in Incident Response Activities* (EPA 2009, reference 16.5) and Chapter 6 of *Multi-Agency Radiological Laboratory Analytical Protocols Manual* (MARLAP 2004, reference 16.6). The matrix used for the determination of plutonium was drinking water from Atlanta, GA. See table in the appendix for a listing of the chemical constituents of the water. Although only ^{238}Pu was used, the method is valid for $^{239/240}\text{Pu}$ as well, as they are chemically identical and there are no differences in the method that would be used to determine these isotopes. Note that this method cannot distinguish between ^{239}Pu and ^{240}Pu and only the sum of the activities of these two isotopes can be determined.
- 1.7. Multi-radionuclide analysis using sequential separation may be possible using this method in conjunction with other rapid methods.
- 1.8. This method is applicable to the determination of soluble plutonium. This method is not applicable to the determination of plutonium isotopes contained in highly insoluble particulate matter possibly present in water samples contaminated as a result of a radiological dispersion device (RDD) or IND event. Solid material filtered from

solutions to be analyzed for plutonium should be treated separately by a method that can dissolve high-temperature-fired plutonium oxides such as a solid fusion technique.

2. Summary of Method

2.1. This method is based on the sequential use of two chromatographic extraction resins to isolate and purify plutonium by removing interfering radionuclides as well as other components of the matrix in order to prepare the plutonium fraction for counting by alpha spectrometry. The method utilizes vacuum-assisted flow to improve the speed of the separations. Prior to using the extraction resins, a water sample is filtered as necessary to remove any insoluble fractions, equilibrated with ^{242}Pu tracer, and concentrated by either evaporation or $\text{Ca}_3(\text{PO}_4)_2$ coprecipitation. The sample test source (STS) is prepared by microprecipitation with NdF_3 . Standard laboratory protocol for the use of an alpha spectrometer should be used when the sample is ready for counting.

3. Definitions, Abbreviations and Acronyms

- 3.1. Analytical Protocol Specifications (APS). The output of a directed planning process that contains the project's analytical data needs and requirements in an organized, concise form.
- 3.2. Analytical Action Level (AAL). The term "analytical action level" is used to denote the value of a quantity that will cause the decisionmaker to choose one of the alternative actions.
- 3.3. Analytical Decision Level (ADL). The analytical decision level refers to the value that is less than the AAL and based on the acceptable error rate and the required method uncertainty.
- 3.4. Discrete Radioactive Particles (DRPs or "hot particles"). Particulate matter in a sample of any matrix where a high concentration of radioactive material is contained in a tiny particle (μm range).
- 3.5. *Multi-Agency Radiological Analytical Laboratory Protocols Manual* (MARLAP) (see Reference 16.6.)
- 3.6. Measurement Quality Objective (MQO). MQOs are the analytical data requirements of the data quality objectives and are project- or program-specific. They can be quantitative or qualitative. MQOs serve as measurement performance criteria or objectives of the analytical process.
- 3.7. Radiological Dispersal Device (RDD), i.e., a "dirty bomb." This is an unconventional weapon constructed to distribute radioactive material(s) into the environment either by incorporating them into a conventional bomb or by using sprays, canisters, or manual dispersal.
- 3.8. Required Method Uncertainty (u_{MR}). The required method uncertainty is a target value for the individual measurement uncertainties, and is an estimate of uncertainty (of measurement) before the sample is actually measured. The required method uncertainty is applicable below an AAL.
- 3.9. Relative Required Method Uncertainty (ϕ_{MR}). The relative required method uncertainty is the u_{MR} divided by the AAL and is typically expressed as a percentage. It is applicable above the AAL.

- 3.10. Sample Test Source (STS). This is the final form of the sample that is used for nuclear counting. This form is usually specific for the nuclear counting technique used in the method such as a solid deposited on a filter for alpha spectrometry analysis.
4. Interferences
- 4.1. Radiological: Alpha-emitting radionuclides with irresolvable alpha energies, such as ^{238}Pu (5.50 MeV), ^{241}Am (5.48 MeV), and ^{228}Th (5.42 MeV), that must be chemically separated to enable measurement. This method separates these radionuclides effectively. The significance of peak overlap will be determined by the individual detector's alpha energy resolution characteristics and the quality of the final precipitate that is counted.
- 4.2. Non-Radiological: Very high levels of competing higher valence anions (greater than divalent such as phosphates) will lead to lower yields when using the evaporation option due to competition with active sites on the resin. If higher valence anions are present phosphate, the precipitation may need to be used initially in place of evaporation. If calcium phosphate coprecipitation is performed to collect plutonium (and other potentially present actinides) from large-volume samples, the amount of phosphate added to coprecipitate the actinides (in Step 11.1.4.3) should be reduced to accommodate the sample's high phosphate concentration.
5. Safety
- 5.1. General
- 5.1.1. Refer to your safety manual for concerns of contamination control, personal exposure monitoring, and radiation dose monitoring.
- 5.1.2. Refer to the laboratory chemical hygiene plan (or equivalent) for general safety rules regarding chemicals in the workplace.
- 5.2. Radiological
- 5.2.1. Hot particles (DRPs)
- 5.2.1.1. Hot particles, also termed "discrete radioactive particles" (DRPs), will be small, on the order of 1 mm or less. Typically, DRPs are not evenly distributed in the media and their radiation emissions are not uniform in all directions (anisotropic). Filtration using a 0.45- μm or finer filter will minimize the presence of these particles.
- 5.2.1.2. Care should be taken to provide suitable containment for filter media used in the pretreatment of samples that may have DRPs, because the particles become highly statically charged as they dry out and will "jump" to other surfaces causing contamination.
- 5.2.1.3. Filter media should be individually surveyed for the presence of these particles, and this information should be reported with the final sample results.
- 5.2.2. For samples with detectable activity concentrations of these radionuclides, labware should be used only once due to potential for cross contamination.
- 5.3. Procedure-Specific Non-Radiological Hazards: Particular attention should be paid to the use of hydrofluoric acid (HF). HF is an extremely dangerous chemical used in the preparation of some of the reagents and in the microprecipitation procedure.

Appropriate personal protective equipment (PPE) must be used in strict accordance with the laboratory safety program specification.

6. Equipment and Supplies

- 6.1. Analytical balance with 0.01-g readability, or better.
- 6.2. Cartridge reservoirs, 10- or 20-mL syringe style with locking device, or equivalent.
- 6.3. Centrifuge able to accommodate 250-mL flasks.
- 6.4. Centrifuge flasks, 250-mL capacity.
- 6.5. Filter with 0.45- μ m membrane.
- 6.6. Filter apparatus with 25-mm-diameter polysulfone filtration chimney, stem support, and stainless steel support. A single-use (disposable) filter funnel/filter combination may be used, to avoid cross-contamination.
- 6.7. 25-mm polypropylene filter, 0.1- μ m pore size, or equivalent.
- 6.8. Stainless steel planchets or other sample mounts able to hold the 25-mm filter.
- 6.9. Tweezers.
- 6.10. 100- μ L pipette or equivalent and appropriate plastic tips.
- 6.11. 10-mL plastic culture tubes with caps.
- 6.12. Vacuum pump or laboratory vacuum system.
- 6.13. Tips, white inner, Eichrom part number AC-1000-IT, or equivalent.
- 6.14. Tips, yellow outer, Eichrom part number AC-1000-OT, or equivalent.
- 6.15. Vacuum box, such as Eichrom part number AC-24-BOX, or equivalent.
- 6.16. Vortex mixer.
- 6.17. Miscellaneous laboratory ware of plastic or glass; 250- and 500-mL capacities.

7. Reagents and Standards

Note: All reagents are American Chemical Society (ACS) reagent grade or equivalent unless otherwise specified.

Note: Unless otherwise indicated, all references to water should be understood to mean Type I Reagent water. All solutions used in microprecipitation should be prepared with water filtered through a 0.45- μ m (or better) filter.

- 7.1. Ammonium hydrogen oxalate (0.1M): Dissolve 6.3 g of oxalic acid ($\text{H}_2\text{C}_2\text{O}_4 \cdot 2\text{H}_2\text{O}$) and 7.1 g of ammonium oxalate ($(\text{NH}_4)_2\text{C}_2\text{O}_4 \cdot \text{H}_2\text{O}$) in 900 mL of water and dilute to 1 L with water.
- 7.2. Ammonium hydrogen phosphate (3.2 M): Dissolve 106 g of $(\text{NH}_4)_2\text{HPO}_4$ in 200 mL of water, heat gently to dissolve and dilute to 250 mL with water.
- 7.3. Ammonium hydroxide: Concentrated NH_4OH , available commercially.
- 7.4. Ammonium thiocyanate indicator (1 M): Dissolve 7.6 g of ammonium thiocyanate (NH_4SCN) in 90 mL of water and dilute to 100 mL with water. An appropriate amount of sodium thiocyanate (8.1 g) or potassium thiocyanate (9.7 g) may be substituted for ammonium thiocyanate.
- 7.5. Ascorbic acid (1 M) - Dissolve 17.6 g of ascorbic acid ($\text{C}_6\text{H}_8\text{O}_6$) in 90 mL of water and dilute to 100 mL with water. Prepare weekly.
- 7.6. Calcium nitrate (0.9M): Dissolve 53 g of calcium nitrate tetrahydrate ($\text{Ca}(\text{NO}_3)_2 \cdot 4\text{H}_2\text{O}$) in 100 mL of water and dilute to 250 mL with water.

- 7.7. Ethanol, 100%: Anhydrous C_2H_5OH , available commercially.
 - 7.7.1. Ethanol (~80% v/v): Mix 80 mL 100% ethanol and 20 mL water.
- 7.8. Ferrous sulfamate (0.6M): Add 57 g of sulfamic acid (NH_2SO_3H) to 150 mL of water, heat to $70^\circ C$, slowly add 7 g of iron powder (< 100 mesh size) while heating and stirring (magnetic stirrer should be used) until dissolved (may take as long as two hours). Filter the hot solution (using a qualitative filter), transfer to flask and dilute to 200 mL with water. Prepare fresh weekly.
- 7.9. Hydrochloric acid (12 M): Concentrated HCl, available commercially.
 - 7.9.1. Hydrochloric acid (4 M): Add 333 mL of concentrated HCl to 500 mL of water and dilute to 1 L with water
 - 7.9.2. Hydrochloric acid (1 M): Add 83 mL of concentrated HCl to 500 mL of water and dilute with water to 1 L.
 - 7.9.3. Hydrochloric acid (9 M): Add 750 mL of concentrated HCl to 100 mL of water and dilute to 1 L with water.
- 7.10. Hydrochloric acid (4 M) - hydrofluoric acid (0.1 M): Add 333 mL of concentrated HCl and 3.6 mL of concentrated HF to 500 mL of water and dilute to 1 L with water. Prepare fresh daily.
- 7.11. Hydrofluoric acid (28M): Concentrated HF, available commercially.
 - 7.11.1. HF (0.58M): Add 20 mL of concentrated HF to 980 mL of filtered demineralized water and mix. Store in a plastic bottle.
- 7.12. Neodymium standard solution (1000 $\mu g/mL$) may be purchased from a supplier of standards for atomic spectroscopy.
- 7.13. Neodymium carrier solution (0.50 mg/mL): Dilute 10 mL of the neodymium standard solution (7.12) to 20.0 mL with filtered demineralized water. This solution is stable.
- 7.14. Neodymium fluoride substrate solution (10 $\mu g/mL$): Pipette 5 mL of neodymium standard solution (7.12) into a 500-mL plastic bottle. Add 460 mL of 1 M HCl to the plastic bottle. Cap the bottle and shake to mix. Measure 40 mL of concentrated HF acid in a plastic graduated cylinder and add to the bottle. Recap the bottle and shake to mix thoroughly. This solution is stable for up to six months.
- 7.15. Nitric acid (16 M): Concentrated HNO_3 , available commercially.
 - 7.15.1. Nitric acid (0.5 M): Add 32 mL of concentrated HNO_3 to 900 mL of water and dilute to 1 L with water.
 - 7.15.2. Nitric acid (2 M): Add 127 mL of concentrated HNO_3 to 800 mL of water and dilute to 1 L with water.
 - 7.15.3. Nitric acid (3 M): Add 191 mL of concentrated HNO_3 to 700 mL of water and dilute to 1 L with water.
- 7.16. Nitric acid (2M) – sodium nitrite (0.1 M) solution: Add 32 mL of concentrated HNO_3 (7.15) to 200 mL of water and mix. Dissolve 1.7 g of sodium nitrite ($NaNO_2$) in the solution and dilute to 250 mL with water. Prepare fresh daily.
- 7.17. Nitric acid (3 M) – aluminum nitrate (1.0 M) solution: Dissolve 213 g of anhydrous aluminum nitrate ($Al(NO_3)_3$) in 700 mL of water, add 190 mL of concentrated HNO_3 (7.15) and dilute to 1 L with water. An appropriate quantity of aluminum nitrate nonahydrate (375 g) may be substituted for anhydrous aluminum nitrate.
- 7.18. Phenolphthalein solution: Dissolve 1 g phenolphthalein in 100 mL 95% isopropyl alcohol and dilute with 100 mL of water.

- 7.19. Plutonium-242 tracer solution – 6-10 dpm of ^{242}Pu per aliquant, activity added known to at least 5% (combined standard uncertainty of no more than 5%).

Note: If it is suspected that ^{242}Pu may be present in the sample, ^{236}Pu tracer would be an acceptable substitute.

- 7.20. TRU Resin – 2-mL cartridge, 50- to 100- μm mesh size, Eichrom part number TR-R50-S and TR-R200-S, or equivalent.
- 7.21. UTEVA Resin – 2-mL cartridge, 50- to 100- μm mesh size, Eichrom part number UT-R50-S and UT-R200-S, or equivalent.

8. Sample Collection, Preservation, and Storage

- 8.1. Samples should be collected in 1-L plastic containers.
- 8.2. No sample perseveration is required if sample is delivered to the laboratory within 3 days of sampling date/time.
- 8.3. If the dissolved concentration of plutonium is sought, the insoluble fraction must be removed by filtration before preserving with acid.
- 8.4. If the sample is to be held for more than three days, HNO_3 shall be added until $\text{pH} < 2$.

9. Quality Control

- 9.1. Batch quality control results shall be evaluated and meet applicable Analytical Project Specifications (APS) prior to release of unqualified data. In the absence of project-defined APS or a project specific quality assurance project plan (QAPP), the quality control sample acceptance criteria defined in the laboratory quality manual and procedures shall be used to determine acceptable performance for this method.
- 9.1.1. A Laboratory Control Sample (LCS) shall be run with each batch of samples. The concentration of the LCS should be at or near the action level or level of interest for the project.
- 9.1.2. One method blank shall be run with each batch of samples. The laboratory blank should consist of laboratory water.
- 9.1.3. One laboratory duplicate shall be run with each batch of samples. The laboratory duplicate is prepared by removing an aliquant from the original sample container.
- 9.1.4. A matrix spike sample may be included as a batch quality control sample if there is concern that matrix interferences may compromise chemical yield measurements or overall data quality.
- 9.2. The source preparation method should produce a sample test source that produces a spectrum with the full width at half maximum (FWHM) of 50-100 keV for each peak in the spectrum. Precipitate reprocessing should be considered if this range of FWHM cannot be achieved.
- 9.3. This method is capable of achieving a u_{MR} of 1.9 pCi/L at or below an action level of 15 pCi/L. This may be adjusted if the event specific MQOs are different.
- 9.4. This method is capable of achieving a required ϕ_{MR} of 13% above 15 pCi/L. This may be adjusted if the event specific MQOs are different.
- 9.5. This method is capable of achieving a required minimum detectable concentration (MDC) of 1.5 pCi/L.

10. Calibration and Standardization

- 10.1. Set up the alpha spectrometry system according to the manufacturer's recommendations. The energy range of the spectrometry system should at least include the region between 3 and 8 MeV.
- 10.2. Calibrate each detector used to count samples according to ASTM Standard Practice D7282, Section 18, "Alpha Spectrometry Instrument Calibrations" (see reference 16.3).
- 10.3. Continuing Instrument Quality Control Testing shall be performed according to ASTM Standard Practice D7282, Sections 20, 21, and 24.

11. Procedure

11.1. *Water Sample Preparation:*

- 11.1.1. As required, filter the 100–200 mL sample aliquant through a 0.45- μm filter and collect the sample in an appropriate size beaker.
- 11.1.2. Acidify the sample with concentrated HNO_3 , to a pH of < 2.0 by adding enough HNO_3 . This usually requires about 2 mL of concentrated HNO_3 per 1000 mL of sample.
- 11.1.3. Add 6–10 dpm of ^{242}Pu as a tracer, following laboratory protocol. The tracer should be added right before you are planning to proceed to Step 11.1.4 or 11.1.5. If the sample solution with the added tracer is not processed right away, isotopic exchange may be compromised and the analytical results will be incorrect.

Note: For a sample approximately 100 mL or less, the evaporation option is recommended. Proceed to Step 11.1.5. Otherwise go to Step 11.1.4.

11.1.4. Calcium phosphate coprecipitation option

- 11.1.4.1. Add 0.5 mL of 0.9-M $\text{Ca}(\text{NO}_3)_2$ to each beaker. Place each beaker on a hot plate, cover with a watch glass, and heat until boiling.
- 11.1.4.2. Once the sample boils, take the watch glass off the beaker and lower the heat.
- 11.1.4.3. Add 2–3 drops of phenolphthalein indicator and 200 μL of 3.2-M $(\text{NH}_4)_2\text{HPO}_4$ solution.
- 11.1.4.4. Add enough concentrated NH_4OH with a squeeze bottle to reach the phenolphthalein end point and form $\text{Ca}_3(\text{PO}_4)_2$ precipitate. NH_4OH should be added very slowly. Stir the solution with a glass rod. Allow the sample to heat gently to digest the precipitate for another 20–30 minutes.
- 11.1.4.5. If the sample volume is too large to centrifuge the entire sample, allow precipitate to settle until solution can be decanted (30 minutes to 2 hours) and go to Step 11.1.4.7.
- 11.1.4.6. If the volume is small enough to centrifuge, go to Step 11.1.4.8.
- 11.1.4.7. Decant supernatant solution and discard to waste.
- 11.1.4.8. Transfer the precipitate to a 250-mL centrifuge tube (rinsing the original container with a few milliliters of water to complete the precipitate transfer) and centrifuge the precipitate for approximately 10 minutes at 2000 rpm.
- 11.1.4.9. Decant supernatant solution and discard to waste.

- 11.1.4.10. Wash the precipitate with an amount of water approximately twice the volume of the precipitate. Mix well using a stirring rod, breaking up the precipitate if necessary. Centrifuge for 5–10 minutes at 2000 rpm. Discard the supernatant solution.
- 11.1.4.11. Dissolve precipitate in approximately 5 mL of concentrated HNO₃. Transfer solution to a 100-mL beaker. Rinse centrifuge tube with 2–3 mL of concentrated HNO₃ and transfer to the same beaker. Evaporate solution to dryness and go to Step 11.2.
- 11.1.5. Evaporation option to reduce volume and to digest organic components
 - 11.1.5.1. Evaporate sample to less than 50 mL and transfer to a 100-mL beaker.

Note: For some water samples, CaSO₄ formation may occur during evaporation. If this occurs, use the Ca₃(PO₄)₂ precipitation option in Step 11.1.4.
 - 11.1.5.2. Gently evaporate the sample to dryness and redissolve in approximately 5 mL of concentrated HNO₃.
 - 11.1.5.3. Repeat Step 11.1.5.2 two more times, evaporate to dryness, and go to Step 11.2.
- 11.2. Actinide Separations using Eichrom resins
 - 11.2.1. Redissolve Ca₃(PO₄)₂ residue or evaporated water sample:
 - 11.2.1.1. Dissolve either residue with 10 mL of 3 M HNO₃–1.0 M Al(NO₃)₃.

Note: An additional 5 mL may be necessary if the residue volume is large.
 - 11.2.1.2. Add 2 mL of 0.6-M ferrous sulfamate to each solution. Swirl to mix.

Note: If the additional 5 mL was used to dissolve the sample in Step 11.2.1.1, add a total of 3 mL of ferrous sulfamate solution.
 - 11.2.1.3. Add 1 drop of 1-M ammonium thiocyanate indicator to each sample and mix.

Note: The color of the solution turns deep red due to the formation of a soluble ferric thiocyanate complex.
 - 11.2.1.4. Add 1 mL of 1-M ascorbic acid to each solution, swirling to mix. Wait for 2-3 minutes.

Note: The red color should disappear, which indicates reduction of Fe⁺³ to Fe⁺². If the red color persists, then additional ascorbic acid solution is added drop-wise with mixing until the red color disappears.

Note: If particles are observed suspended in the solution, centrifuge the sample. The supernatant solution will be transferred to the column in Step 11.2.3.1. The precipitates will be discarded.
 - 11.2.2. Set up of UTEVA and TRU cartridges in tandem on the vacuum box system

Note: Steps 11.2.2.1 to 11.2.2.5 deal with a commercially available filtration system. Other vacuum systems developed by individual laboratories may be substituted here as long as the laboratory has provided guidance to analysts in their use.

- 11.2.2.1. Place the inner tube rack (supplied with vacuum box) into the vacuum box with the centrifuge tubes in the rack. Fit the lid to the vacuum box system.
- 11.2.2.2. Place the yellow outer tips into all 24 openings of the lid of the vacuum box. Fit in the inner white tip into each yellow tip.
- 11.2.2.3. For each sample solution, fit in the TRU cartridge on to the inner white tip. Ensure the UTEVA cartridge is locked to the top end of the TRU cartridge.
- 11.2.2.4. Lock syringe barrels (funnels/reservoirs) to the top end of the UTEVA cartridge.
- 11.2.2.5. Connect the vacuum pump to the box. Turn the vacuum pump on and ensure proper fitting of the lid.

IMPORTANT: The unused openings on the vacuum box should be sealed. Yellow caps (included with the vacuum box) can be used to plug unused white tips to achieve good seal during the separation.

- 11.2.2.6. Add 5 mL of 3-M HNO₃ to the funnel to precondition the UTEVA and TRU cartridges.
- 11.2.2.7. Adjust the vacuum pressure to achieve a flow-rate of ~1 mL/min.

IMPORTANT: Unless otherwise specified in the procedure, use a flow rate of ~1 mL/min for load and strip solutions and ~3 mL/min for rinse solutions.

- 11.2.3. Preliminary purification of the plutonium fraction using UTEVA and TRU resins
 - 11.2.3.1. Transfer each solution from Step 11.2.1.4 into the appropriate funnel by pouring or by using a plastic transfer pipette. Allow solution to pass through both cartridges at a flow rate of ~1 mL/min.
 - 11.2.3.2. Add 5 mL of 3-M HNO₃ to each beaker (from Step 11.2.1.4) as a rinse and transfer each solution into the appropriate funnel (the flow rate can be adjusted to ~3 mL/min).
 - 11.2.3.3. Add 5 mL of 3-M HNO₃ into each funnel as second column rinse (flow rate ~3 mL/min).
 - 11.2.3.4. Separate UTEVA cartridge from TRU cartridge. Discard UTEVA cartridge and the effluent collected so far. Place new funnel on the TRU cartridge.
- 11.2.4. Final plutonium separation using TRU cartridge
 - 11.2.4.1. Pipette 5 mL of 2-M HNO₃ into each TRU cartridge from Step 11.2.3.4. Allow to drain.
 - 11.2.4.2. Pipette 5 mL of 2-M HNO₃-0.1-M NaNO₂ directly into each cartridge, rinsing each cartridge reservoir while adding the 2 M HNO₃ - 0.1-M NaNO₂.

IMPORTANT: The flow rate for the cartridge should be adjusted to ~1 mL/min for this step.

Note: Sodium nitrite is used to oxidize any Pu⁺³ to Pu⁺⁴ and optimize the separation from other trivalent actinides possibly present in the sample.

- 11.2.4.3. Allow the rinse solution to drain through each cartridge.
- 11.2.4.4. Add 5 mL of 0.5-M HNO₃ to each cartridge and allow it to drain (flow rate left at ~1 mL/min).

Note: 0.5 M HNO₃ is used to lower the nitrate concentration prior to conversion to the chloride system.

Note: Steps 11.2.4.5 and 11.2.4.6 may be omitted if the samples are known *not to contain* americium.

- 11.2.4.5. Add 3 mL of 9-M HCl to each cartridge to convert to chloride system.
- 11.2.4.6. Add 20 mL of 4-M HCl to remove americium.
- 11.2.4.7. Rinse the cartridge with 25 mL of 4-M HCl–0.1-M HF. Discard all the eluates collected so far to waste (for this step, the flow rate can be increased to ~3 mL/min).

Note: 4-M HCl – 0.1-M HF rinse selectively removes any residual Th that may still be present on the TRU cartridge. The plutonium remains on the cartridge.

- 11.2.4.8. Ensure that clean, labeled plastic tubes are placed in the tube rack under each cartridge.
- 11.2.4.9. Add 10 mL of 0.1-M ammonium bioxalate (NH₄HC₂O₄) to elute plutonium from each cartridge, reducing the flow rate to ~1 mL/min.
- 11.2.4.10. Set plutonium fraction in the plastic tube aside for neodymium fluoride coprecipitation, Step 11.3.
- 11.2.4.11. Discard the TRU cartridge.

11.3. Preparation of the Sample Test Source

Note: Instructions below describe preparation of a single Sample Test Source. Several STSs can be prepared simultaneously if a multi-channel vacuum box (whale apparatus) is available.

- 11.3.1. Add 100 µL of the neodymium carrier solution to the tube with a micropipette. Gently swirl the tube to mix the solution.
- 11.3.2. Add 1 mL of concentrated HF to the tube and mix well by gentle swirling.
- 11.3.3. Cap the tube and place it in a cold-water bath for at least 30 minutes.
- 11.3.4. Insert the polysulfone filter stem in the 250-mL vacuum flask. Place the stainless steel screen on top of the fitted plastic filter stem.

- 11.3.5. Place a 25-mm polymeric filter face up on the stainless steel screen. Center the filter on the stainless steel screen support and apply vacuum. Wet the filter with 100% ethanol, followed by filtered Type I water.

Caution: There is no visible difference between the two sides of the filter. If the filter is turned over accidentally, it is recommended that the filter be discarded and a fresh one removed from the box.

- 11.3.6. Lock the filter chimney firmly in place on the filter screen and wash the filter with additional filtered Type I water.
- 11.3.7. Pour 5.0 mL of neodymium substrate solution down the side of the filter chimney, avoiding directing the stream at the filter. When the solution passes through the filter, wait at least 15 seconds before the next step.
- 11.3.8. Repeat Step 11.3.7 with an additional 5.0 mL of the substrate solution.
- 11.3.9. Pour the sample from Step 11.3.3 down the side of the filter chimney and allow the vacuum to draw the solution through.
- 11.3.10. Rinse the tube twice with 2 mL of 0.58-M HF, stirring each wash briefly using a vortex mixer, and pouring each wash down the side of the filter chimney.
- 11.3.11. Repeat rinse, using 2 mL of filtered Type I water once.
- 11.3.12. Repeat rinse using 2 mL of 80% ethyl alcohol once.
- 11.3.13. Wash any drops remaining on the sides of the chimney down toward the filter with a few milliliters of 80% ethyl alcohol.

Caution: Directing a stream of liquid onto the filter will disturb the distribution of the precipitate on the filter and render the sample unsuitable for α -spectrometry resolution.

- 11.3.14. Without turning off the vacuum, remove the filter chimney.
- 11.3.15. Turn off the vacuum to remove the filter. Discard the filtrate to waste for future disposal. If the filtrate is to be retained, it should be placed in a plastic container to avoid dissolution of the glass vessel by dilute HF.
- 11.3.16. Place the filter on a properly labeled mounting disc, secure with a mounting ring or other device that will render the filter flat for counting.
- 11.3.17. Let the sample air-dry for a few minutes and when dry, place in a container suitable for transfer and submit for counting.

Note: Other methods for STS preparation, such as electroplating or microprecipitation with cerium fluoride, may be used in lieu of the neodymium fluoride microprecipitation, but any such substitution must be validated as described in Section 1.5

12. Data Analysis and Calculations

- 12.1. Equation for determination of final result, combined standard uncertainty and radiochemical yield (if required):

The activity concentration of an analyte and its combined standard uncertainty are calculated using the following equations:

$$AC_a = \frac{A_t \times R_a \times D_t \times I_t}{V_a \times R_t \times D_a \times I_a}$$

and

$$u_c(AC_a) = \sqrt{u^2(R_a) \times \frac{A_t^2 \times D_t^2 \times I_t^2}{V_a^2 \times R_t^2 \times D_a^2 \times I_a^2} + AC_a^2 \times \left(\frac{u^2(A_t)}{A_t^2} + \frac{u^2(V_a)}{V_a^2} + \frac{u^2(R_t)}{R_t^2} \right)}$$

where:

- AC_a = activity concentration of the analyte at time of count, in picocuries per liter (pCi/L)
- A_t = activity of the tracer added to the sample aliquant at its reference date/time (pCi)
- R_a = net count rate of the analyte in the defined region of interest (ROI), in counts per second
- R_t = net count rate of the tracer in the defined ROI, in counts per second
- V_a = volume of the sample aliquant (L)
- D_t = correction factor for decay of the tracer from its reference date and time to the midpoint of the counting period
- D_a = correction factor for decay of the analyte from the time of sample collection (or other reference time) to the midpoint of the counting period (if required)
- I_t = probability of α emission in the defined ROI per decay of the tracer (Table 17.1)
- I_a = probability of α emission in the defined ROI per decay of the analyte (Table 17.1)
- $u_c(AC_a)$ = combined standard uncertainty of the activity concentration of the analyte (pCi/L)
- $u(A_t)$ = standard uncertainty of the activity of the tracer added to the sample (pCi)
- $u(V_a)$ = standard uncertainty of the volume of sample aliquant (L)
- $u(R_a)$ = standard uncertainty of the net count rate of the analyte (s^{-1})
- $u(R_t)$ = standard uncertainty of the net count rate of the tracer (s^{-1})

Note: The uncertainties of the decay-correction factors and of the probability of decay factors are assumed to be negligible.

Note: The equation for the combined standard uncertainty ($u_c(AC_a)$) calculation is arranged to eliminate the possibility of dividing by zero if $R_a = 0$.

Note: The standard uncertainty of the activity of the tracer added to the sample must reflect that associated with the activity of the standard reference material and any other significant sources of uncertainty such as those introduced during the preparation of the tracer solution (e.g., weighing or dilution factors) and during the process of adding the tracer to the sample.

- 12.1.1. The net count rate of an analyte or tracer and its standard uncertainty are calculated using the following equations:

$$R_x = \frac{C_x}{t_s} - \frac{C_{bx}}{t_b}$$

and

$$u(R_x) = \sqrt{\frac{C_x + 1}{t_s^2} + \frac{C_{bx} + 1}{t_b^2}}$$

where:

R_x	=	net count rate of analyte or tracer, in counts per second
C_x	=	sample counts in the analyte or the tracer ROI
t_s	=	sample count time (s)
C_{bx}	=	background counts in the same ROI as for x
t_b	=	background count time (s)
$u(R_x)$	=	standard uncertainty of the net count rate of tracer or analyte, in counts per second ¹

If the radiochemical yield of the tracer is requested, the yield and its combined standard uncertainty can be calculated using the following equations:

$$RY = \frac{R_t}{0.037 \times A_t \times D_t \times I_t \times \varepsilon}$$

and

$$u(RY) = RY \times \sqrt{\frac{u^2(R_t)}{R_t^2} + \frac{u^2(A_t)}{A_t^2} + \frac{u^2(\varepsilon)}{\varepsilon^2}}$$

where:

RY	=	radiochemical yield of the tracer, expressed as a fraction
R_t	=	net count rate of the tracer, in counts per second
A_t	=	activity of the tracer added to the sample (pCi)
D_t	=	correction factor for decay of the tracer from its reference date and time to the midpoint of the counting period
I_t	=	probability of α emission in the defined ROI per decay of the tracer (Table 17.1)
ε	=	detector efficiency, expressed as a fraction
$u_c(RY)$	=	combined standard uncertainty of the radiochemical yield
$u(R_t)$	=	standard uncertainty of the net count rate of the tracer, in counts per second
$u(A_t)$	=	standard uncertainty of the activity of the tracer added to the sample (pCi)

¹ For methods with very low counts, MARLAP Section 19.5.2.2 recommends adding one count each to the gross counts and the background counts when estimating the uncertainty of the respective net counts. This minimizes negative bias in the estimate of uncertainty and protects against calculating zero uncertainty when a total of zero counts are observed for the sample and background.

$u(\varepsilon)$ = standard uncertainty of the detector efficiency

12.1.2. If the critical level concentration (S_c) or the minimum detectable concentration (MDC) are requested (at an error rate of 5%), they can be calculated using the following equations:²

$$S_c = \frac{\left[0.4 \times \left(\frac{t_s}{t_b} - 1 \right) + 0.677 \times \left(1 + \frac{t_s}{t_b} \right) + 1.645 \times \sqrt{\left(R_{ba} t_b + 0.4 \right) \times \frac{t_s}{t_b} \times \left(1 + \frac{t_s}{t_b} \right)} \right] \times A_t \times D_t \times I_t}{t_s \times V_a \times R_t \times D_a \times I_a}$$

$$\text{MDC} = \frac{\left[2.71 \times \left(1 + \frac{t_s}{t_b} \right) + 3.29 \times \sqrt{R_{ba} t_s \times \left(1 + \frac{t_s}{t_b} \right)} \right] \times A_t \times D_t \times I_t}{t_s \times V_a \times R_t \times D_a \times I_a}$$

where:

R_{ba} = background count rate for the analyte in the defined ROI, in counts per second

12.2. Results Reporting

12.2.1. The following data should be reported for each result: volume of sample used; yield of tracer and its uncertainty; and FWHM of each peak used in the analysis.

12.2.2. The following conventions should be used for each result:

12.2.2.1. Result in scientific notation \pm combined standard uncertainty.

12.2.2.2. If solid material was filtered from the solution and analyzed separately, the results of that analysis should be reported separately as pCi/L of the original volume from which the solids were filtered if no other guidance is provided on reporting of results for the solids. For example:

^{239/240}Pu for Sample 12-1-99:

Filtrate Result: 12.8 \pm 1.5 pCi/L

Filtered Residue Result: 2.5 \pm 0.3 pCi/L

13. Method Performance

13.1. Method validation results are to be reported.

13.2. Expected turnaround time per batch 14 samples plus QC, assuming microprecipitations for the whole batch are performed simultaneously using a vacuum box system:

13.2.1. For an analysis of a 200 mL sample aliquant, sample preparation and digestion should take ~3.5 h.

² The formulations for the critical level and minimum detectable concentration are based on the Stapleton Approximation as recommended in MARLAP Section 20A.2.2, Equations 20.54 and 20A.3.2, and Equation 20.74, respectively. The formulations presented here assume an error rate of $\alpha = 0.05$, $\beta = 0.05$ (with $z_{1-\alpha} = z_{1-\beta} = 1.645$) and $d = 0.4$. For methods with very low numbers of counts, these expressions provide better estimates than do the traditional formulas for the critical level and MDC.

- 13.2.2. Purification and separation of the plutonium fraction using cartridges and vacuum box system should take ~2 h.
 - 13.2.3. The sample test source preparation step takes ~1 h.
 - 13.2.4. A one-hour counting time should be sufficient to meet the MQOs listed in 9.3 and 9.4, assuming detector efficiency of 0.2–0.3, and radiochemical yield of at least 0.5. A different counting time may be necessary to meet these MQOs if any of the relevant parameters are significantly different.
 - 13.2.5. Data should be ready for reduction ~7.5 h after beginning of analysis.
14. Pollution Prevention: The method utilizes small volume (2 mL) extraction chromatographic resin columns. This approach leads to a significant reduction in the volumes of load, rinse and strip solutions, as compared to classical methods using ion exchange resins to separate and purify the plutonium fraction.
15. Waste Management
- 15.1. Types of waste generated per sample analyzed
 - 15.1.1. If $\text{Ca}_3(\text{PO}_4)_2$ coprecipitation is performed, 100–1000 mL of decanted solution that is pH neutral will be generated
 - 15.1.2. Approximately 45 mL of acidic waste from loading and rinsing the two extraction columns will be generated. These solutions may contain an unknown quantity of ^{241}Am , if this radionuclide was present in the sample originally. If the presence of ^{241}Am is suspected, combined eluates from Steps 11.2.4.5 and 11.2.4.6 should be collected separately from other rinses, to minimize quantity of mixed waste generated.
 - 15.1.3. Approximately 45 mL of acidic waste from the microprecipitation method for source preparation will be generated. The waste contains 1 mL of HF and ~ 8 mL of ethanol.
 - 15.1.4. Unless processed further, the UTEVA cartridge may contain isotopes of uranium, neptunium, and thorium, if any of these were present in the sample originally.
 - 15.1.5. TRU cartridge – ready for appropriate disposal.
 - 15.2. Evaluate all waste streams according to disposal requirements by applicable regulations.
16. References
- 16.1. ACW03 VBS, Rev. 1.6, “Americium, Plutonium, and Uranium in Water (with Vacuum Box System),” Eichrom Technologies, Inc., Lisle, Illinois (February 2005).
 - 16.2. G-03, V.1 “Microprecipitation Source Preparation for Alpha Spectrometry”, HASL-300, 28th Edition, (February 1997).
 - 16.3. ASTM D7282 “Standard Practice for Set-up, Calibration, and Quality Control of Instruments Used for Radioactivity Measurements,” ASTM Book of Standards 11.02, current version, ASTM International, West Conshohocken, PA.
 - 16.4. VBS01, Rev.1.3, “Setup and Operation Instructions for Eichrom’s Vacuum Box System (VBS),” Eichrom Technologies, Inc., Lisle, Illinois (January 2004).
 - 16.5. U.S. Environmental Protection Agency (EPA). 2009. *Method Validation Guide for Radiological Laboratories Participating in Incident Response Activities*. Revision 0.

Office of Air and Radiation, Washington, DC. EPA 402-R-09-006, June. Available at: www.epa.gov/narel/incident_guides.html.

- 16.6. *Multi-Agency Radiological Laboratory Analytical Protocols Manual (MARLAP)*. 2004. EPA 402-B-1304 04-001A, July. Volume I, Chapters 6, 7, 20, Glossary; Volume II and Volume III, Appendix G. Available at: www.epa.gov/radiation/marlap/index.html.
- 16.7. ASTM D1193, "Standard Specification for Reagent Water," ASTM Book of Standards 11.02, current version, ASTM International, West Conshohocken, PA.

17. Tables, Diagrams, Flow Charts, and Validation Data

17.1. Tables

Table 17.1 Alpha Particle Energies and Abundances of Importance^[1]

Nuclide	Half-Life (Years)	λ (s ⁻¹)	Abundance ^[2]	α Energy (MeV)
²³⁸ Pu	87.7	2.50×10^{-10}	0.7091	5.499
			0.2898	5.456
^{239/240} Pu (Total) ^[3]	2.411×10^4	9.110×10^{-13}	0.9986	(All at same peak)
²³⁹ Pu	2.411×10^4	9.110×10^{-13}	0.7077	5.157
			0.1711	5.144
			0.1194	5.105
²⁴⁰ Pu	6.561×10^3	3.348×10^{-12}	0.7280	5.168
			0.2710	5.124
²⁴² Pu	3.735×10^5	5.881×10^{-14}	0.7649	4.902
			0.2348	4.858

[1] Only the most abundant particle energies and abundances have been noted here.

[2] Unless individual plutonium isotopes are present, the alpha emissions for ^{239/240}Pu or separately for ²³⁸Pu, should use an abundance factor of 1.0.

[3] Half-life and λ are based on ²³⁹Pu.

17.2. Ingrowth Curves and Ingrowth Factors

This section intentionally left blank

17.3. Spectrum from a Processed Sample

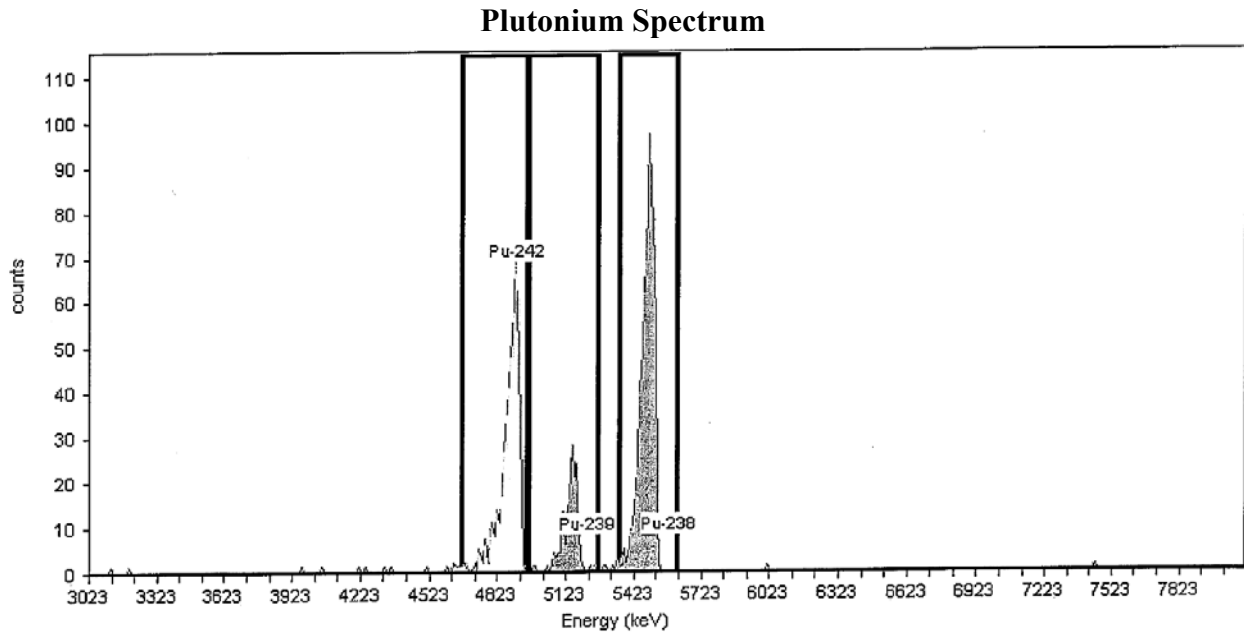

17.4. Decay Scheme

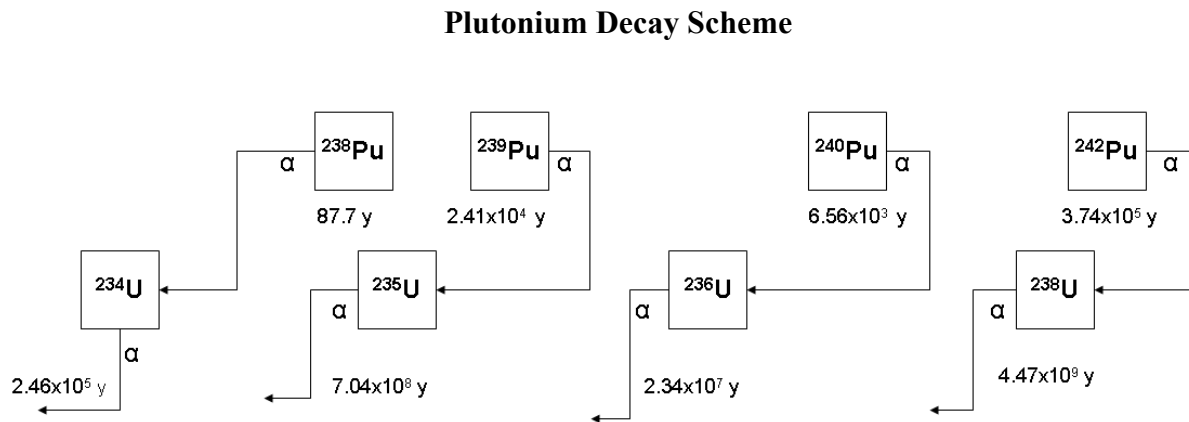

17.5. Flow chart

Analytical Flow Chart for Plutonium

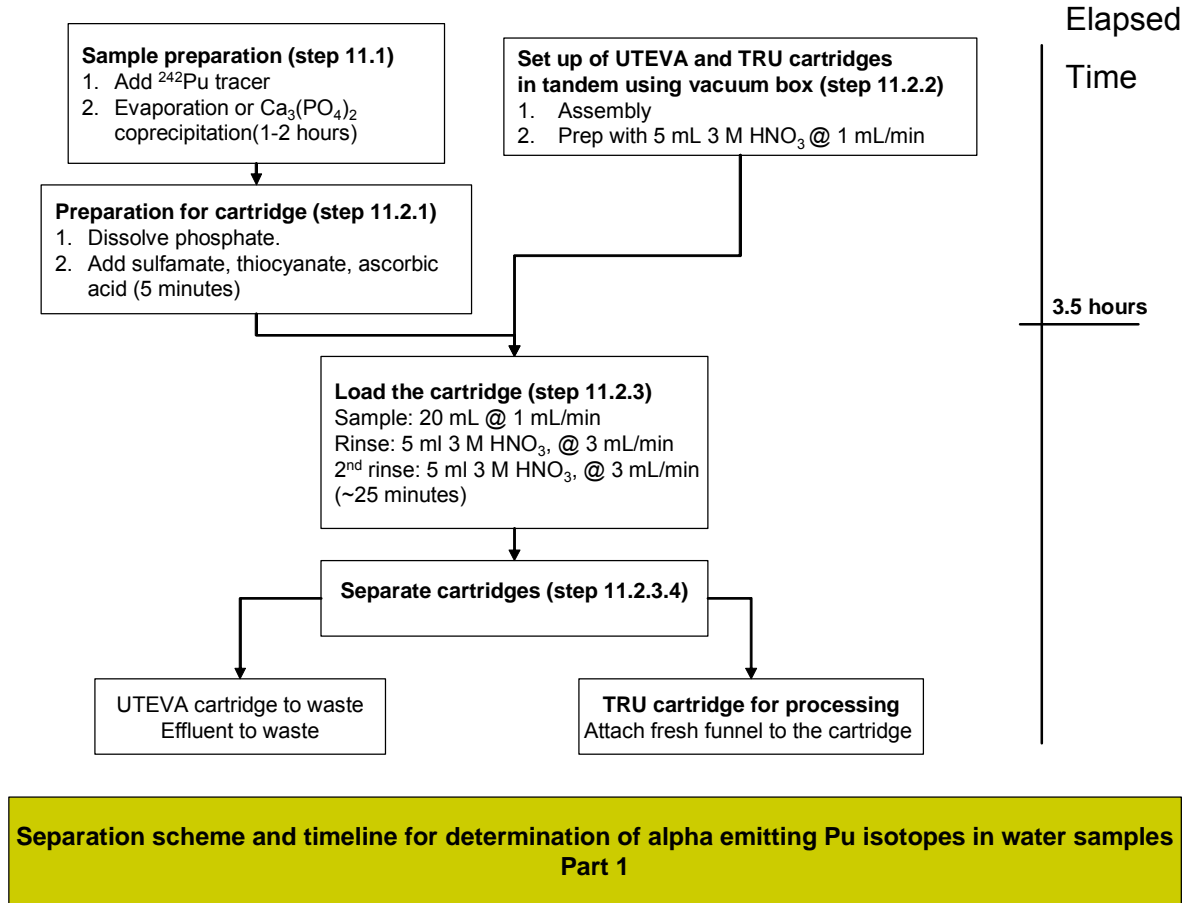

Plutonium-238, 239/240 in Water: Rapid Radiochemical Method for High-Activity Samples

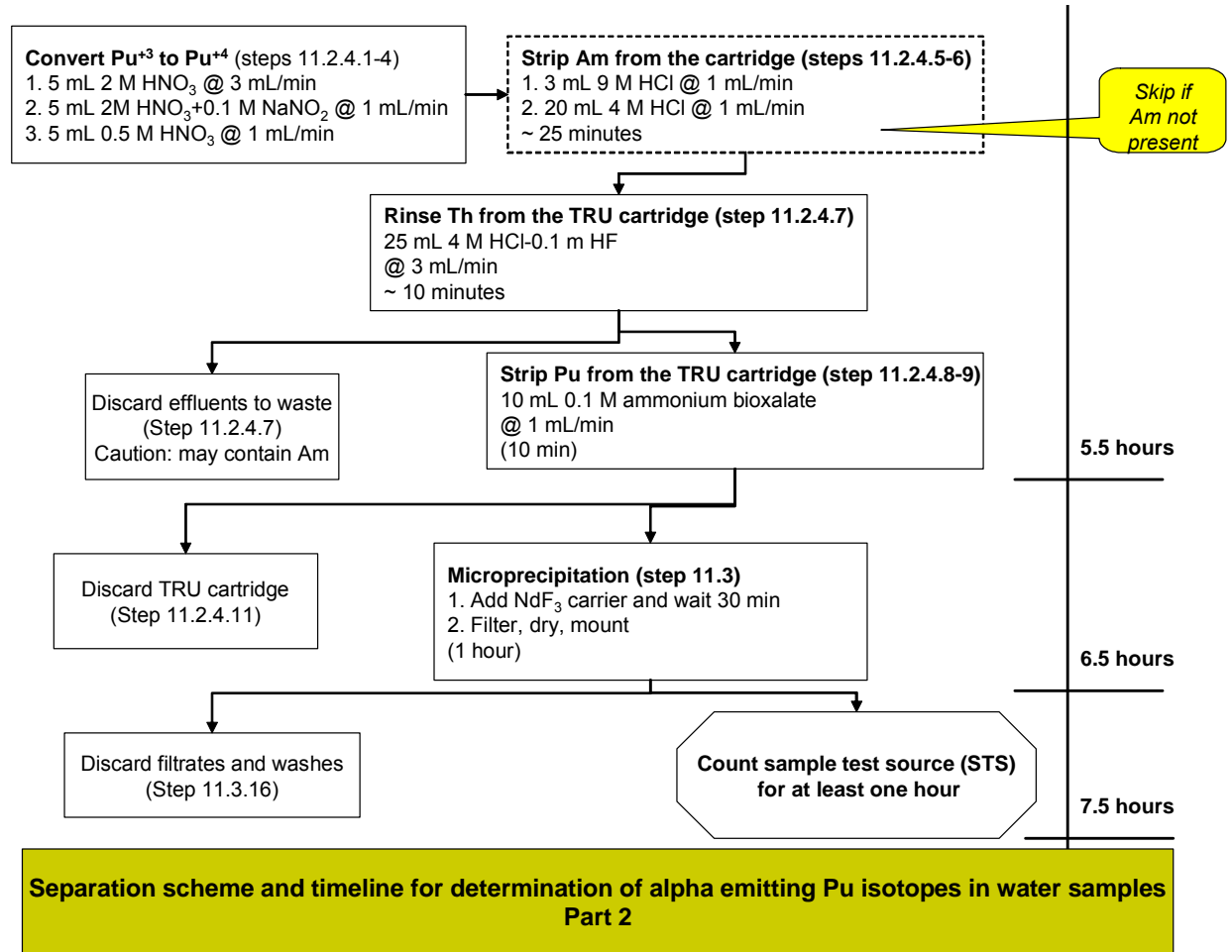

Appendix

Table A1 – Composition of Atlanta Drinking Water Used for this Study

Metals by ICP-AES	Concentration (mg/L)*
Silicon	3.18
Aluminum	<0.200
Barium	0.0133
Calcium	9.38
Iron	<0.100
Magnesium	<0.500
Potassium	<0.500
Sodium	<0.500
Inorganic Anions	
Chloride	12.7
Sulfate	15.6
Nitrogen, Nitrate (as N)	1.19
Carbon Dioxide	
Bicarbonate Alkalinity	23.8
Carbonate Alkalinity	<3.00
Radionuclide	Concentration (pCi/L)**
Uranium 234, 235, 238	<0.01, <0.01, <0.01
Plutonium 238, 239/240	<0.02, <0.02
Americium 241	<0.02
Strontium 90	<0.3
Radium 226***	0.11 ± 0.27 -0.30 ± 0.45

Note: Analyses conducted by independent laboratories.

* Values below the reporting level are presented as less than (<) values.

No measurement uncertainty was reported with values greater than the "Reporting Level."

** Reported values represent the calculated minimum detectable concentration (MDC) for the radionuclide(s).

*** Two samples analyzed.

www.epa.gov
February 2010
Revision 0

Rapid Radiochemical Method for Radium-226 in Water for Environmental Restoration Following Homeland Security Events

U.S. Environmental Protection Agency

**Office of Air and Radiation
Office of Radiation and Indoor Air
National Air and Radiation Environmental Laboratory
Montgomery, AL 36115**

**Office of Research and Development
National Homeland Security Research Center
Cincinnati, OH 45268**

**RADIUM-226 IN WATER:
RAPID METHOD TECHNIQUE FOR HIGH-ACTIVITY SAMPLES**

1 Scope and Application

- 1.1. The method will be applicable to samples where contamination is either from known or unknown origins. If any filtration of the sample is performed prior to starting the analysis, filterable solids should be analyzed separately. The results from the analysis of these solids should be reported separately (as a suspended activity concentration for the water volume filtered), but identified with the filtrate results.
- 1.2. This method uses rapid radiochemical separations techniques for the isotopic determination of ^{226}Ra in water samples following a nuclear or radiological incident. Although the method can detect ^{226}Ra concentrations on the same order of magnitude as methods used for the Safe Drinking Water Act (SDWA), this method is not a substitute for SDWA-approved methods for ^{226}Ra .
- 1.3. The method is specific for ^{226}Ra and uses MnO_2 fixed on a resin bed (MnO_2 resin) to separate radium from interfering radionuclides and matrix constituents with additional separation using Diphonix[®] resin¹ to improve selectivity by removing radioactive impurities.
- 1.4. The method is capable of satisfying a required method uncertainty for ^{226}Ra of 0.65 pCi/L at an analytical action level of 5 pCi/L. To attain the stated measurement quality objectives (MQOs) (see Sections 9.3, 9.4, and 9.5), a sample volume of approximately 200 mL and count time of 4 hours are recommended. Application of the method must be validated by the laboratory using the protocols provided in *Method Validation Guide for Qualifying Methods Used by Radiological Laboratories Participating in Incident Response Activities* (EPA 2009, reference 16.3). The sample turnaround time and throughput may vary based on additional project MQOs, the time for analysis of the final counting form and initial sample volume.
- 1.5. This method is intended to be used for water samples that are similar in composition to drinking water. The rapid ^{226}Ra method was evaluated following the guidance presented for “Level E Method Validation: Adapted or Newly Developed Methods, Including Rapid Methods” in *Method Validation Guide for Qualifying Methods Used by Radiological Laboratories Participating in Incident Response Activities* (EPA 2009, reference 16.3) and Chapter 6 of *Multi-Agency Radiological Laboratory Analytical Protocols Manual* (MARLAP 2004, reference 16.4). The matrix used for the determination of ^{226}Ra was drinking water from Atlanta, GA. See Appendix A for a listing of the chemical constituents of the water.
- 1.6. Multi-radionuclide analysis using sequential separation techniques may be possible.

2 Summary of Method

- 2.1. A known quantity of ^{225}Ra is used as the yield determinant in this analysis. Since the source of the suspected contamination may not be known, the sample is initially digested using concentrated nitric acid, followed by volume reduction and conversion to the chloride salt using concentrated hydrochloric acid. The solution is adjusted to a

¹ A polyfunctional cation exchange resin containing diphosphonic and sulfonic acid functional groups bonded to a polystyrene/divinylbenzene spherical bead. (Available commercially from Eichrom Technologies, LLC, Lisle, IL, 60561).

neutral pH and batch equilibrated with MnO₂ resin to separate radium from some radioactive and non-radioactive matrix constituents. Further selectivity is achieved using a column which contains Diphonix[®] resin. The radium (including ²²⁶Ra) eluted from the column is prepared for counting by microprecipitation with BaSO₄.

- 2.2. Low-level measurements are performed by alpha spectrometry. The activity measured in the ²²⁶Ra region of interest is corrected for chemical yield based on the observed activity of the alpha peak at 7.07 MeV (²¹⁷At, the third progeny of ²²⁵Ra). See Table 17.1 for a list of alpha particle energies of the radionuclides that potentially may be seen in the alpha spectra.

3 Definitions, Abbreviations and Acronyms

- 3.1. Analytical Protocol Specifications (APS). The output of a *directed planning process* that contains the project's analytical data needs and requirements in an organized, concise form.
- 3.2. Analytical Action Level (AAL). The term "analytical action level" is used to denote the value of a quantity that will cause the decisionmaker to choose one of the alternative actions.
- 3.3. Analytical Decision Level (ADL). The analytical decision level refers to the value that is less than the AAL based on the acceptable error rate and the required method uncertainty.
- 3.4. Discrete Radioactive Particles (DRPs or Hot Particles). Particulate matter in a sample of any matrix where a high concentration of radioactive material is contained in a tiny particle (micron range).
- 3.5. *Multi-Agency Radiological Analytical Laboratory Protocols Manual* (MARLAP) (see Reference 16.4).
- 3.6. Measurement Quality Objective (MQO). The analytical data requirements of the data quality objectives that are project- or program-specific and can be quantitative or qualitative. These analytical data requirements serve as measurement performance criteria or objectives of the analytical process.
- 3.7. Radiological Dispersal Device (RDD), i.e., a "dirty bomb." This is an unconventional weapon constructed to distribute radioactive material(s) into the environment either by incorporating them into a conventional bomb or by using sprays, canisters, or manual dispersal.
- 3.8. Required Method Uncertainty (u_{MR}). The required method uncertainty is a target value for the individual measurement uncertainties and is an estimate of uncertainty (of measurement) before the sample is actually measured. The required method uncertainty as an absolute value is applicable at or below an AAL.
- 3.9. Relative Required Method Uncertainty (ϕ_{MR}). The relative required method uncertainty is the u_{MR} divided by the AAL and is typically expressed as a percentage. It is applicable above the action level.
- 3.10. Sample Test Source (STS). This is the final form of the sample that is used for nuclear counting. This form is usually specific for the nuclear counting technique in the method, such as a solid deposited on a filter for alpha spectrometry analysis.

4 Interferences

- 4.1. Radiological:

- 4.1.1. All radium isotopes in addition to ^{226}Ra are retained on MnO_2 , as are thorium isotopes. Unless other radium isotopes are present in concentrations greater than approximately three times the ^{226}Ra activity concentration, interference from other radium alphas will be resolved when using alpha spectrometry. Method performance may be compromised if samples contain high levels of radium isotopes due to ingrowth of interfering decay progeny. Samples should be pre-screened prior to aliquanting and appropriate limits established to control the amount of activity potentially present in the aliquant.²
- 4.1.2. Decay progeny from the ^{225}Ra tracer will continue to ingrow as more time elapses between the separation of radium and the count of the sample. Delaying the count significantly longer than a day may introduce a possible positive bias in results near the detection threshold. When MQOs require measurements close to detection levels, and coordinating sample processing and counting schedules is not conducive to counting the sample within ~36 hours of the separation of radium, the impact of tracer progeny tailing into the ^{226}Ra may be minimized by reducing the activity of the ^{225}Ra tracer that is added to the sample. This will aid in improving the signal-to-noise ratio for the ^{226}Ra peak by minimizing the amount of tailing from higher energy alphas of the ^{225}Ra progeny.
 - 4.1.2.1. The amount of ^{225}Ra added to the samples may be decreased, and the time for ingrowth between separation and counting increased, to ensure that sufficient ^{225}Ac , ^{221}Fr , and ^{217}At are present for yield corrections at the point of the count. Although this detracts from the rapidity of the method, it does not detract from the potential for high throughput.
 - 4.1.2.2. The size of the sample aliquant can be increased without changing the amount of tracer added.
- 4.1.3. Optimally, a purified ^{225}Ra tracer solution³ should be used when performing this method.
 - 4.1.3.1. When using a purified source of ^{225}Ra , the beginning of decay for ^{225}Ra is the activity reference date established during standardization of the ^{225}Ra solution.
 - 4.1.3.2. When a purified ^{225}Ra tracer solution is not available, a solution containing ^{225}Ra in equilibrium with ^{229}Th may be used as a tracer. In this case, the ^{225}Ra activity is supported only until thorium is removed using Diphonix[®] resin during processing of the sample. When using this variation of the method, the beginning of ^{225}Ra decay is the point when the sample has passed through the Diphonix[®] column.

NOTE: Recording the point in time of the beginning of ^{225}Ra decay to within ½ hour will introduce a maximum bias of 0.1% for this measurement.

² For very elevated levels of radium isotopes, it is recommended that laboratories use “The Determination of Radium-226 and Radium-228 in Drinking Water by Gamma-ray Spectrometry Using HPGE or Ge(Li) Detectors,” Revision 1.2, December 2004. Available from the Environmental Resources Center, Georgia Institute of Technology, 620 Cherry Street, Atlanta, GA 30332-0335, USA, Telephone: 404-894-3776.

³ Using a purified ^{225}Ra tracer is the approach recommended for this method. See Appendix B for a method for purification and standardization of ^{225}Ra tracer from ^{229}Th solution.

- 4.1.4. Every effort should be made to use the purified ^{225}Ra as a tracer. It is also possible to use ^{225}Ra in equilibrium with ^{229}Th , which may be added to each sample as a tracer.⁴ This approach requires complete decontamination of a relatively high activity of ^{229}Th by the Diphonix[®] column later in the method, however, since the spectral region of interest (ROI) for ^{229}Th slightly overlaps that of ^{226}Ra . Inadequate decontamination of ^{229}Th will lead to high bias in the ^{226}Ra result especially when the levels of ^{226}Ra in the sample are below 1 pCi/L. The spectral region above ^{226}Ra corresponding to ^{229}Th should be monitored as a routine measure to identify samples where ^{229}Th interference may impact compliance with project MQOs. If problematic levels of ^{229}Th are identified in spectra, measures must be taken to address the interference. These might include:
- 4.1.4.1. Separating ^{225}Ra from ^{229}Th prior to its use as a tracer. Using purified ^{225}Ra tracer is the default approach recommended for running this method since it will completely address any potential for interference by removing the source of the problem.
 - 4.1.4.2. Increasing the sample aliquant size without changing the amount of tracer added will increase analyte signal and reduce the relative impact of the interference to levels that may be amenable with project MQOs.
 - 4.1.4.3. The absolute amount of ^{229}Th added to the samples may be decreased, as long as the time for ingrowth between separation and counting is increased to ensure that sufficient ^{217}At is present for yield corrections at the point of the count. Although this detracts from the rapidity of the method, it allows more flexibility in the timing of the count and does not detract from the potential for high throughput.
 - 4.1.4.4. Developing spill-down factors (peak overlap corrections) to correct for the interference and account for additional uncertainty in the analytical results. This is not a trivial determination and should be validated prior to use.
- 4.1.5. When a solution containing ^{225}Ra in equilibrium with ^{229}Th is used as a tracer, thorium is removed later in the processing of the sample. The equilibrium between the ^{225}Ra and ^{229}Th is maintained only until the sample is loaded onto the Diphonix[®] column. At this point, thorium and actinium are retained on the column and the ^{225}Ra activity in the eluate is unsupported and begins to decay.
- 4.2. Non-radiological:
- 4.2.1. Low conductivity water ($<100\ \mu\text{S cm}^{-1}$) may cause low-yield issues with some samples. This may be partially corrected for by increasing the conductivity with calcium standard solution.
 - 4.2.2. Concentrations of non-radioactive barium present significantly in excess of the amount of barium carrier added for microprecipitation may severely degrade the resolution of alpha spectra. The quality of spectra should be monitored for evidence of decreased resolution. A decreased sample size (i.e., smaller) may

⁴ The single-laboratory validation for this method was performed successfully by adding ^{225}Ra in secular equilibrium with ^{229}Th tracer. Using purified ^{225}Ra will provide better method performance since it will eliminate any concern about breakthrough of the high levels of ^{229}Th added to each sample. See Appendix B of this method for a method for separating (and standardizing) ^{225}Ra tracer from ^{229}Th solution.

need to be selected or the barium carrier decreased or omitted if the presence of these interferences leads to unacceptably degraded method performance.

- 4.2.3. High concentrations of non-radioactive calcium, magnesium or strontium in the sample may not only overwhelm the ability of the MnO₂ resin to effectively exchange radium isotopes but also may degrade the alpha spectrometry peaks and increase analytical uncertainty. A decreased sample size (i.e., smaller) may need to be selected when the presence of these interferences leads to degraded method performance. If it is anticipated that these elements or barium (see Step 4.2.2) are present in quantities exceeding a small fraction of the mass of calcium or barium added in Steps 11.2.3 and 11.1.3, respectively, an analytical determination may need to be performed separately so that the interference can be accommodated.

5 Safety

5.1. General

- 5.1.1. Refer to your safety manual for concerns of contamination control, personal exposure monitoring and radiation dose monitoring.
- 5.1.2. Refer to the laboratory chemical hygiene plan for general chemical safety rules.

5.2. Radiological

5.2.1. Hot Particles (DRPs)

5.2.1.1. Hot particles, also termed “discrete radioactive particles” (DRPs), will be small, on the order of 1 mm or less. Typically, DRPs are not evenly distributed in the media and their radiation emissions are not uniform in all directions (anisotropic). Filtration using a 0.45- μ m or finer filter will minimize the presence of these particles.

5.2.1.2. Care should be taken to provide suitable containment for filter media used in the pretreatment of samples that may have DRPs, because the particles become highly statically charged as they dry out and will “jump” to other surfaces causing contamination.

5.2.1.3. Filter media should be individually surveyed for the presence of these particles, and this information reported with the final sample results.

5.2.2. For samples with detectable activity concentrations of these radionuclides, labware should be used only once due to the potential for cross contamination.

5.3. Procedure-Specific Non-Radiological Hazards:

- 5.3.1. Solutions of 30% H₂O₂ can rapidly oxidize organic materials and generate significant heat. Do not mix large quantities of peroxide solution with solutions of organic solvents as the potential for conflagration exists.

6 Equipment and supplies

- 6.1. Alpha spectrometer calibrated for use over the range of ~3.5-10 MeV.
- 6.2. Centrifuge tubes, polypropylene, 50 mL, disposable; or equivalent.
- 6.3. Chromatography columns, polypropylene, disposable:
 - 6.3.1. 1.5 cm I.D. \times 15 cm, with funnel reservoir; or equivalent.
 - 6.3.2. 0.8 cm I.D. \times 4 cm; or equivalent.
- 6.4. Filter stand and filter funnels.
- 6.5. Filter, 0.1 micron, ~25-mm diameter (suitable for microprecipitation).

Radium-226 in Water: Rapid Radiochemical Method for High-Activity Samples

- 6.6. Membrane filter, 0.45 micron, ~47-mm diameter.
- 6.7. Vacuum filtration apparatus.
- 6.8. Heat lamp, 250-300 watt, with reflectors mounted ~25 cm above the base.
- 6.9. Petri dish or other suitable container for storing sample test sources.
- 6.10. Stainless steel planchets or suitable holders/backing for sample test sources – able to accommodate a 25-mm diameter filter.
- 6.11. Glass beaker, 600-mL capacity.
- 6.12. Stirring hot plate.
- 6.13. Magnetic stir bar (optional).
- 6.14. Centrifuge bottle, polypropylene, 250 mL, disposable; or equivalent (optional).

7 Reagents and Standards

Note: All reagents are American Chemical Society (ACS) reagent grade or equivalent unless otherwise specified.

Note: Unless otherwise indicated, all references to water should be understood to mean Type I Reagent water (ASTM D1193). For microprecipitation, all solutions used in microprecipitation should be prepared with water filtered through a 0.45 μm (or smaller) filter.

- 7.1. Ammonium sulfate, solid $(\text{NH}_4)_2\text{SO}_4$, available commercially.
- 7.2. Barium carrier (nominally 0.5 mg/mL as Ba^{2+}). May be purchased as an atomic absorption standard and diluted, or prepared by dissolving 0.45 g reagent grade barium chloride, dihydrate ($\text{BaCl}_2 \cdot 2\text{H}_2\text{O}$) in water and diluting to 500 mL with water.
- 7.3. Bromthymol blue indicator solution: Dissolve 0.1 g of bromthymol blue in 16 mL of 0.01 M NaOH. Dilute to 250 mL with water.
- 7.4. Calcium nitrate solution (1000 ppm as calcium). May be purchased as an atomic absorption standard and diluted or prepared by dissolving 2.5 g of calcium carbonate (CaCO_3) in 70 mL of concentrated nitric acid and diluting to 1 L with water.
- 7.5. Diphonix[®] resin, 100–200- μm mesh size [available from Eichrom Technologies, Lisle, IL].
- 7.6. Ethanol, reagent 95 % ($\text{C}_2\text{H}_5\text{OH}$), available commercially.
- 7.7. Hydrochloric acid (12 M): Concentrated HCl, available commercially.
 - 7.7.1. Hydrochloric acid (2M): Add 170 mL of concentrated HCl to 800 mL of water and dilute to 1.0 L with water.
 - 7.7.2. Hydrochloric acid (1M): Add 83 mL of concentrated HCl to 800 mL of water and dilute to 1.0 L with water.
- 7.8. Hydrogen peroxide, H_2O_2 (30 % w/w), available commercially.
- 7.9. Isopropanol, 2-propanol, ($\text{C}_3\text{H}_7\text{OH}$), available commercially.
 - 7.9.1. Isopropanol (2-propanol), 20 % (v/v) in water: Mix 20 mL of isopropanol with 80 mL of water.
- 7.10. Methanol (CH_3OH), available commercially.
- 7.11. MnO_2 resin, 75-150 μm MnO_2 particle size on non-functionalized polystyrene resin beads of 100-200 mesh [available commercially from Eichrom Technologies, Lisle, IL].
- 7.12. MnO_2 stripping reagent: Add 2 mL of 30 % H_2O_2 per 100 mL of 2 M HCl. Prepare fresh for each use.
- 7.13. Nitric acid (16 M): Concentrated HNO_3 , available commercially.

- 7.14. Sodium hydroxide (1 M): Dissolve 4 g of sodium hydroxide (NaOH) in 50 mL of water and dilute the solution to 100 mL.
 - 7.15. Ra-225 tracer in 1-M HCl solution in a concentration amenable to accurate addition of about 180 dpm per sample (generally about 150–600 dpm/mL).
 - 7.15.1. Ra-225 may be purified and standardized using a $^{229}\text{Th} / ^{225}\text{Ra}$ generator as described in Appendix B of this method.
 - 7.15.2. Th-229 containing an equilibrium concentration of ^{225}Ra has been successfully used without prior separation of the ^{225}Ra . However, this approach may be problematic due to the risk of high result bias (see discussion in Steps 4.1.4 – 4.1.5).
- 8 Sample Collection, Preservation and Storage
- 8.1. Samples should be collected in 1-L plastic containers.
 - 8.2. No sample preservation is required if sample analysis is initiated within 3 days of sampling date/time.
 - 8.3. If the sample is to be held for more than three days, HNO_3 shall be added until the solution pH is less than 2.0.
 - 8.4. If the dissolved concentration of radium is sought, the insoluble fraction must be removed by filtration before preserving with acid.
- 9 Quality Control
- 9.1. Batch quality control results shall be evaluated and meet applicable Analytical Project Specifications (APS) prior to release of unqualified data. In the absence of project-defined APS or a project-specific quality assurance project plan (QAPP), the quality control sample acceptance criteria defined in the laboratory quality manual and procedures shall be used to determine acceptable performance for this method.
 - 9.1.1. A laboratory control sample (LCS) shall be run with each batch of samples. The concentration of the LCS should be at or near the action level or a level of interest for the project.
 - 9.1.2. One method blank shall be run with each batch of samples. The laboratory blank should consist of demineralized water.
 - 9.1.3. One laboratory duplicate shall be run with each batch of samples. The laboratory duplicate is prepared by removing an aliquant from the original sample container.
 - 9.1.4. A matrix spike sample may be included as a batch quality control sample if there is concern that matrix interferences, such as the presence of elemental barium in the sample, may compromise chemical yield measurements, or overall data quality.
 - 9.2. Sample-specific quality control measures
 - 9.2.1. Limits and evaluation criteria shall be established to monitor each alpha spectrum to ensure that spectral resolution and peak separation is adequate to provide quantitative results. When $^{229}\text{Th} / ^{225}\text{Ra}$ solution is added directly to the sample, the presence of detectable counts between ~5.0 MeV and the upper boundary established for the ^{226}Ra ROI generally indicates the presence of ^{229}Th in the sample, and in the ^{226}Ra ROI. If the presence of ^{229}Th is noted and the concentration of ^{226}Ra is determined to be an order of

magnitude below the action limit or the detection threshold of the method, take corrective actions to ensure that MQOs have not been compromised (e.g., clean-up ^{225}Ra tracer before adding, or re-process affected samples and associated QC samples. See interferences sections Steps 4.1.4 – 4.1.5. for discussion).

- 9.3. This method is capable of achieving a u_{MR} of 0.65 pCi/L at or below an action level of 5.0 pCi/L. This may be adjusted in the event specific MQOs are different.
- 9.4. This method is capable of achieving a ϕ_{MR} 13% above 5 pCi/L. This may be adjusted if the event specific MQOs are different.
- 9.5. This method is capable of achieving a required minimum detectable concentration (MDC) of 1.0 pCi/L.

10 Calibration and Standardization

- 10.1. Set up, operate, calibrate and perform quality control for alpha spectrometry units in accordance with the laboratory's quality manual and standard operating procedures and consistent with ASTM Standard Practice D7282, Sections 7-13, 18, and 24 (see reference 16.5).

Note: The calibrated energy range for the alpha spectrometer for this method should be from ~3.5 to 10 MeV

- 10.2. If ^{225}Ra is separated and purified from ^{229}Th for use as a tracer, the activity reference date established during standardization of the tracer is used as the ^{225}Ra activity reference date (see Appendix B of this method).
- 10.3. When using ^{229}Th containing an equilibrium concentration of ^{225}Ra , the time of most recent separation / purification of the ^{229}Th standard solution must be known in order to determine the extent of secular equilibrium between ^{229}Th and its ^{225}Ra progeny. Verify the date of purification by examining the Certificate of Analysis, or other applicable documentation, for the standard.
- 10.4. When using ^{229}Th containing an equilibrium concentration of ^{225}Ra , ^{225}Ra is separated from its ^{229}Th parent as the solution passes through the Diphonix column. This is the beginning of ^{225}Ra decay and the date and time used for decay correction of the tracer.
 - 10.4.1. If the purification date of the ^{229}Th is not documented, at least 100 days must have elapsed between separation and use to ensure that ^{229}Th , and its progeny ^{225}Ra are in full secular equilibrium (i.e., >99%. See Table 17.3).

11 Procedure

- 11.1. Initial Sample Treatment
 - 11.1.1. For each sample in the batch, aliquant 0.2 L of raw or filtered water into a beaker.

Note: Smaller or larger aliquants may be used if elevated sample activity is present or as needed to meet detection requirements or MQOs. Method validation must be conducted using approximately the same volume as that to be used in sample analysis.

- 11.1.2. To each aliquant, add 10 mL of concentrated nitric acid per 100 mL of sample.
- 11.1.3. To each sample aliquant, add 100 μ L of 0.5 mg/mL (nominal) barium carrier solution and approximately 180 dpm of ^{225}Ra tracer solution. The initial amount of ^{225}Ra added as a tracer should be high enough so that the resultant counting uncertainty of the ^{217}At activity ingrown from the tracer is five percent (5 %) or less during the allotted sample count time.

Note: The activity of ^{217}At present at the midpoint of the count is used to calculate the chemical yield for radium by back-calculating the activity of ^{225}Ra recovered. The initial amount of ^{225}Ra added as tracer may need to be varied to accommodate planned differences in the time that will elapse between chemical separation and the count, but the activity should be sufficient, and the count time long enough, to ensure that the resultant counting uncertainty for the ^{217}At peak is five (5 %) percent or less. See the calculation for A_t in Step 12.2 for calculation of ingrowth factor for ^{217}At and Table 17.2 for typical ingrowth factors for a series of ingrowth times.

- 11.1.4. Reduce the sample volume to ~20% of the original volume by bringing the solution to a gentle boil and evaporating.
- 11.1.5. Following this digestion, add 10 mL of concentrated hydrochloric acid, and carefully evaporate the solution to incipient dryness.
- 11.1.6. Reconstitute the sample by adding 100 mL of 1-M HCl. The sample may be gently heated if necessary to facilitate dissolution of residual salts.
- 11.2. Water Sample Preparation and Pre-concentration of Radium on MnO_2 resin:
 - 11.2.1. Add 100 mL of 1-M NaOH to each sample.
 - 11.2.2. If particulate material is visible at this time, filter the sample through a 0.45- μ m filter. (Do not rinse the filter). The filter should be saved for possible analysis for DRPs.
 - 11.2.3. Add enough 1000 ppm calcium solution to the filtrate from Step 11.2.2 to ensure that the final calcium concentration is about 10 ppm. For waters that naturally have calcium in them above 10 ppm this step will be unnecessary.
 - 11.2.4. Add a few drops of bromthymol blue indicator solution and adjust each sample to neutral pH by carefully adding 1-M NaOH until the color changes from yellow to blue-green.

Note: Adding too much base will overshoot the blue-green endpoint (indicated by blue color). The amount of NaOH added in Step 11.2.4 may be adjusted by carefully adding a small quantity of 1-M HCl and 1-M NaOH as needed to reach a blue-green endpoint.

- 11.2.5. The sample is equilibrated with ~1.0 g MnO_2 resin for 0.5–1.5 hours. Two options are provided:
 - 11.2.5.1. Option 1: Add ~1.0 g MnO_2 resin to a beaker containing the neutralized sample. Cover with a watch glass and stir on a magnetic stirrer for at least 30 minutes.
 - 11.2.5.2. Option 2: Transfer the neutralized sample to a 250 mL centrifuge bottle which contains ~1.0 g MnO_2 resin. Agitate the bottle gently on a shaker or in a tumbler for at least 30 minutes.

Note: Two options are provided for contacting the sample with MnO₂ resin. The contact time noted above (30 minutes) is to be understood as a minimum. Higher radium yields may be obtained with somewhat longer contact times (up to 90 minutes). Excessive agitation of the resin may lead to abrasion and loss of some MnO₂ from the resin and result in degraded chemical yields. Although sample quantitation is not significantly impacted since a ²²⁵Ra yield tracer is used, uptake on the resin during this step should be reasonably optimized by evaluating the process and time used and choosing a default optimal conditions corresponding to a minimum of 80-85% uptake from a clean water matrix.

- 11.2.6. Pour the suspension into a 1.5-cm I.D. × 15-cm column fitted with a reservoir funnel. Allow sample to pass through column. Rinse the walls of the funnel reservoir and column with demineralized water. The combined column effluent from this step may be discarded.
- 11.2.7. Place a clean 50 mL centrifuge tube under each MnO₂ column. Add 10 mL of freshly made MnO₂ Stripping Reagent to the MnO₂ column to elute radium and other elements. Catch the column eluate containing radium and retain for subsequent processing.

Note: Effervescence will be noted upon addition of the MnO₂ Stripping Reagent. Gently tapping the column to dislodge any bubbles that form will help minimize channeling and may improve radium recovery. The resin bed will become light yellow in color as MnO₂ dissolves.

- 11.3. Actinium and Thorium Removal Using Diphonix[®] resin:
 - 11.3.1. Prepare a Diphonix[®] resin column for each sample to be processed as follows:⁵
 - 11.3.1.1. Slurry ~1.0 gram Diphonix[®] resin per column in water.
 - 11.3.1.2. Transfer the resin to the 0.8-cm I.D. × 4-cm columns to obtain a uniform resin bed of ~1.4–1.6 mL (bed height ~26–30 mm). A top column barrier (e.g., frit, glass wool, beads) may be used to minimize turbulence that may disrupt the resin bed when adding solution to the column.
 - 11.3.2. Precondition the column by passing 20 mL of 2-M HCl through the column discarding the column effluent.
 - 11.3.3. Place a clean 50-mL centrifuge tube under each Diphonix[®] column.
 - 11.3.4. Swirl the solution retained in Step 11.2.7 to remove bubbles and carefully load onto the column taking care to minimize disturbing the resin bed. Collect column effluents in the 50-mL centrifuge tube. Allow the solution to flow by gravity.
 - 11.3.5. When the load solution has stopped flowing (or is below the top of the resin bed), rinse the column with two 5-mL volumes of 2-M HCl. Collect the rinse solutions in the same 50-mL centrifuge tube (the total volume will be approximately 20 mL).

⁵ Commercially supplied pre-packed columns may be used here. When packing columns using bulk resin, excessive resin fines should be removed by rinsing the resin one or more times with an excess of water and decanting the water containing the fines prior to transferring the material to the column.

- 11.3.6. Record the date and time of the last rinse (Step 11.3.5) as the date and time of separation of radium from parent and progeny. This is also the beginning of ingrowth of ^{225}Ac (and ^{221}Fr and ^{217}At).

Note: If purified ^{225}Ra tracer is added to the sample (see Step 10.2 and Appendix B), the ^{225}Ra activity was unsupported before the tracer solution was added to the sample. The activity reference date and time established during standardization of the ^{225}Ra tracer is used as the reference date for the ^{225}Ra solution.

Note: If ^{225}Ra at some degree of secular equilibrium with ^{229}Th is added as tracer in the initial step, the activity of ^{225}Ra is dependent upon the total amount of time between the last ^{229}Th purification and Step 11.3.6. The decay of ^{225}Ra starts at Step 11.3.6.

Note: The Diphonix[®] resin contains thorium, actinium and possibly other radionuclides present in the sample and should be disposed of according to applicable laboratory procedures.

- 11.4. Barium sulfate micro-precipitation of ^{226}Ra
- 11.4.1. Add ~3.0 g of $(\text{NH}_4)_2\text{SO}_4$ to the 20 mL of 2M HCl solution collected from the Diphonix[®] column in Steps 11.3.3 – 11.3.5. Mix gently to completely dissolve the salt (dissolves readily).
 - 11.4.2. Add 5.0 mL of isopropanol and mix gently (to avoid generating bubbles).
 - 11.4.3. Place in an ultrasonic bath filled with cold tap water (ice may be added) for at least 20 minutes.
 - 11.4.4. Pre-wet a 0.1-micron filter using methanol or ethanol. Filter the suspension through the filter using vacuum. The precipitate *will not be* visually apparent.
 - 11.4.5. Rinse the sample container and filter apparatus with three 2-mL portions of 20% isopropanol solution to dissolve residual $(\text{NH}_4)_2\text{SO}_4$. Allow each rinse to completely pass through filter before adding the subsequent rinse.
 - 11.4.6. Rinse the filter apparatus with about 2 mL of methanol or ethanol to facilitate drying. Turn off vacuum.
 - 11.4.7. Carefully remove the filter and place it face-side up in a Petri dish. Carefully dry under a heating lamp for few minutes. Avoid excessive heat which may cause the filter to curl or shrink.
 - 11.4.8. Mount the dried filter on a support appropriate for the counting system to be used.
 - 11.4.9. Store the filter for at least 24 hours to allow sufficient ^{217}At (third progeny of ^{225}Ra) to ingrow into the sample test source allowing a measurement uncertainty for the ^{217}At of $< \sim 5\%$.
 - 11.4.10. Count by alpha spectrometry. The count times should be adjusted to meet the uncertainties and detection capabilities identified in Steps 9.3, 9.4, and 9.5.

12 Data Analysis and Calculations

- 12.1. The final sample test source (filter mounted on a planchet) will need to have at least a 24-hour ingrowth for ^{225}Ac (and ^{221}Fr and ^{217}At) to meet Analytical Protocol Specifications for chemical yield with a counting time of 4 hours. At-217 (third

progeny of ^{225}Ra) has a single, distinct alpha peak with a centroid at 7.067 MeV and is used for determining the yield.

Note: Actinium 225 and other decay progeny from the ^{225}Ra (e.g., ^{217}At) tracer will continue to ingrow as time elapses between separation and the count of the sample. Delaying the count significantly longer than a day may introduce a possible positive bias in results near the detection threshold. When sample counting will be delayed longer than 36 hours, and MQOs foresee decisions being made close to detection levels, the impact of tracer progeny tailing should be minimized. Possible approaches for accomplishing this may include improving the signal to noise ratio by: 1) Processing a larger sample aliquant; 2) Decreasing the tracer activity added to a level that will still provide adequate statistics ~400–1500 net counts at the time of the analysis but will minimize spilldown into the ^{226}Ra ROI.

12.2. While the radiochemical yield is not directly used to determine the ^{226}Ra activity of the sample, the following equation can be used to calculate the radiochemical yield (see Reference 16.6), if required:

$$RY = \frac{R_t - R_b}{\varepsilon \times A_t \times I_t}$$

Where:

RY	=	Fractional radiochemical yield based on ^{225}Ra (from ingrown ^{217}At at 7.07 MeV)
R_t	=	Total count rate beneath the ^{217}At peak at 7.07 MeV, cpm
R_b	=	Background count rate for the same region, cpm
ε	=	Efficiency for the alpha spectrometer

Note: If ^{225}Ra is separated from ^{229}Th for use as a purified tracer, the ^{225}Ra activity is unsupported and begins to decay at the point of separation from ^{229}Th , and not in Step 11.3.6. Instead, the reference date and time established when the tracer is standardized is used for decay correction of the ^{225}Ra activity. If ^{229}Th solution (with ^{225}Ra in full secular equilibrium) is added to the sample, the ^{225}Ra activity is equal to the ^{229}Th activity added and only begins to decay at the point of separation of ^{225}Ra from ^{229}Th in Step 11.3.6.

A_t	=	The activity of ^{217}At at midpoint of the count (the target value that should be achieved for 100% yield), in dpm. $= 3.0408 \left(I_t \left(A_{^{225}\text{Ra}} \right) \left[e^{-\lambda_1 d} - e^{-\lambda_2 d} \right] \right)$
$A_{^{225}\text{Ra}}$	=	Activity in dpm of ^{225}Ra tracer added to the sample in Step 11.1.3 decay corrected to the date and time of radium separation in Step 11.3.6. ⁶

⁶ When separated ^{225}Ra tracer is added to the sample, its initial activity, $A_{^{225}\text{Ra-initial}}$, must be corrected for decay from the reference date established during standardization of the tracer to the point of separation of ^{225}Ra and ^{225}Ac as follows:

$$A_{^{225}\text{Ra}} = \left(A_{^{225}\text{Ra-initial}} \right) \left(e^{-\lambda_1 d_t} \right)$$

where: λ_1 = decay constant for ^{225}Ra (0.04652 d⁻¹); and d_t = time elapsed between the activity reference date for the ^{225}Ra tracer solution added to the sample and the separation of ^{225}Ra and ^{225}Ac in Step 11.3.6 (days).

When ^{229}Th containing ingrown ^{225}Ra is added directly to the sample, the amount of ^{225}Ra ingrown since purification of the ^{229}Th solution is calculated as:

$$A_{^{225}\text{Ra}} = \left(A_{^{229}\text{Th}} \right) \left(1 - e^{-\lambda_1 d_t} \right)$$

- d = Elapsed ingrowth time for ^{225}Ac [and the progeny ^{217}At], in days from the date and time of Ra separation to the midpoint of the sample count
- λ_1 = 0.04652 d^{-1} (decay constant for ^{225}Ra – half-life = 14.9 days)
- λ_2 = 0.06931 d^{-1} (decay constant for ^{225}Ac – half-life = 10.0 days)
- I_t = Fractional abundance for the 7.07 MeV alpha peak counted (= 0.9999)
- 3.0408 = $\lambda_2/(\lambda_2 - \lambda_1)$ [a good approximation as the half lives of ^{221}Fr and ^{217}At are short enough so that secular equilibrium with ^{225}Ac is ensured]

12.3. The activity concentration of an analyte and its combined standard uncertainty are calculated using the following equations:

$$AC_a = \frac{A_t \times R_{na}}{V_a \times R_{nt} \times D_a \times I_a \times 2.22}$$

and

$$u_c(AC_a) = \sqrt{u^2(R_{na}) \times \frac{A_t^2}{V_a^2 \times R_{nt}^2 \times D_a^2 \times I_a^2 \times 2.22^2} + AC_a^2 \times \left(\frac{u^2(A_t)}{A_t^2} + \frac{u^2(V_a)}{V_a^2} + \frac{u^2(R_{nt})}{R_{nt}^2} \right)}$$

where:

- AC_a = activity concentration of the analyte at time of count, (pCi/L)
- A_t = the theoretical activity of ^{217}At at midpoint of the count that should be achieved for 100% yield, in dpm (see Step 12.2 for detailed calculation)
- R_{na} = net count rate of the analyte in the defined region of interest (ROI), in counts per minute (*Note that the peaks at 4.784 and 4.602 MeV are generally included in the ROI for ^{226}Ra*)
- R_{nt} = net count rate of the tracer in the defined ROI, in counts per minute
- V_a = volume of the sample aliquant (L)
- D_a = correction factor for decay of the analyte from the time of sample collection (or other reference time) to the midpoint of the counting period, if required
- I_a = probability of α emission for ^{226}Ra (*The combined peaks at 4.78 and 4.602 MeV are generally included in the ROI with an abundance of 1.00.*)⁷
- $u_c(AC_a)$ = combined standard uncertainty of the activity concentration of the analyte (pCi/L)
- $u(A_t)$ = standard uncertainty of the activity of the tracer added to the sample (dpm)

where: $A_{229\text{Th}}$ = Activity of the ^{229}Th standard on the date of the separation of Th and Ra (Step 11.3.6); λ_1 = decay constant for ^{225}Ra (0.04652 d^{-1}); and d_i = time elapsed between the purification of ^{229}Th solution added to the sample and the separation of ^{225}Ra and $^{229}\text{Th}/^{225}\text{Ac}$ in Step 11.3.6 (days).

⁷ If the individual peak at 4.78 MeV used, and completely resolved from the 4.602 MeV peak, the abundance would be 0.9445.

- $u(V_a)$ = standard uncertainty of the volume of sample aliquant (L)
 $u(R_{na})$ = standard uncertainty of the net count rate of the analyte in counts per minute
 $u(R_{nt})$ = standard uncertainty of the net count rate of the tracer in counts per minute

Note: The uncertainties of the decay-correction factors and of the probability of decay factors are assumed to be negligible.

Note: The equation for the combined standard uncertainty ($u_c(AC_a)$) calculation is arranged to eliminate the possibility of dividing by zero if $R_a = 0$.

Note: The standard uncertainty of the activity of the tracer added to the sample must reflect that associated with the activity of the standard reference material and any other significant sources of uncertainty such as those introduced during the preparation of the tracer solution (e.g., weighing or dilution factors) and during the process of adding the tracer to the sample.

12.3.1 The net count rate of an analyte or tracer and its standard uncertainty can be calculated using the following equations:

$$R_{nx} = \frac{C_x}{t_s} - \frac{C_{bx}}{t_b}$$

and

$$u(R_{nx}) = \sqrt{\frac{C_x + 1}{t_s^2} + \frac{C_{bx} + 1}{t_b^2}}$$

where:

- R_{nx} = net count rate of analyte or tracer, in counts per minute⁸
 C_x = sample counts in the analyte or the tracer ROI
 t_s = sample count time (min)
 C_{bx} = background counts in the same ROI as for x (x refers to the respective analyte or tracer count)
 t_b = background count time (min)
 $u(R_{nx})$ = standard uncertainty of the net count rate of tracer or analyte, in counts per minute

12.3.2 If the critical level concentration (S_c) or the minimum detectable concentration (MDC) are requested (at an error rate of 5%), they can be calculated using the following equations.⁹

⁸ For methods with very low counts, MARLAP Section 19.5.2.2 recommends adding one count each to the gross counts and the background counts when estimating the uncertainty of the respective net counts. This minimizes negative bias in the estimate of uncertainty and protects against calculating zero uncertainty when a total of zero counts are observed for the sample and background.

⁹ The formulations for the critical level and minimum detectable concentration are based on the Stapleton Approximation as recommended in MARLAP Section 20A.2.2, Equations 20.54 and 20A.3.2, and Equation 20.74, respectively. The formulations presented here assume an error rate of $\alpha = 0.05$, $\beta = 0.05$ (with $z_{1-\alpha} = z_{1-\beta} = 1.645$),

$$S_c = \frac{\left[0.4 \times \left(\frac{t_s}{t_b} - 1 \right) + 0.677 \times \left(1 + \frac{t_s}{t_b} \right) + 1.645 \times \sqrt{\left(R_{ba} t_b + 0.4 \right) \times \frac{t_s}{t_b} \times \left(1 + \frac{t_s}{t_b} \right)} \right] \times A_t \times D_t \times I_t}{t_s \times V_a \times R_t \times D_a \times I_a}$$

$$\text{MDC} = \frac{\left[2.71 \times \left(1 + \frac{t_s}{t_b} \right) + 3.29 \times \sqrt{R_{ba} t_s \times \left(1 + \frac{t_s}{t_b} \right)} \right] \times A_t}{t_s \times V_a \times R_{nt} \times D_a \times I_a \times 2.22}$$

where:

R_{ba} = background count rate for the analyte in the defined ROI, in counts per minute

12.4 Results Reporting

12.4.1 The following data should be reported for each result: volume of sample used; yield of tracer and its uncertainty; and full width at half maximum (FWHM) of each peak used in the analysis.

12.4.2 The following conventions should be used for each result:

12.4.2.1 Result in scientific notation \pm combined standard uncertainty.

12.4.2.2 If solid material was filtered from the solution and analyzed separately, the results of that analysis should be reported separately as pCi/L of the original volume from which the solids were filtered if no other guidance is provided on reporting of results for the solids. For example:

²²⁶Ra for Sample 12-1-99:

Filtrate Result: 12.8 \pm 1.5 pCi/L

Filtered Residue Result: 2.5 \pm 0.3 pCi/L

13 Method Performance

13.1 Results of method validation performance are to be archived and available for reporting purposes.

13.2 Expected turnaround time for an individual sample is ~35 hours and per batch is ~38 hours.

14 Pollution Prevention

14.1 The use of MnO₂ and Diphonix[®] resin reduces the amount of solvents that would otherwise be needed to co-precipitate and purify the final sample test source.

15 Waste Management

15.1 Nitric acid and hydrochloric acid wastes should be neutralized before disposal and then disposed of in accordance with local ordinances.

and $d = 0.4$. For methods with very low numbers of counts, these expressions provide better estimates than do the traditional formulas for the critical level and MDC.

- 15.2 All final precipitated materials contain tracer and should be dealt with as radioactive waste and disposed of in accordance with the restrictions provided in the facility's NRC license.

16 References

- 16.1 RAW04-10, "Radium-226/228 in Water (MnO₂ Resin and DGA Resin Method)," Eichrom Technologies, Lisle Illinois (June 2006).
- 16.2 A Rapid Method For Alpha-Spectrometric Analysis of Radium Isotopes in Natural Waters Using Ion-Selective Membrane Technology; S. Purkl and A. Eisenhauer. *Applied Radiation and Isotopes* 59(4):245-54 (Oct 2003).
- 16.3 U.S. Environmental Protection Agency (EPA). 2009. *Method Validation Guide for Radiological Laboratories Participating in Incident Response Activities*. Revision 0. Office of Air and Radiation, Washington, DC. EPA 402-R-09-006, June. Available at: www.epa.gov/narel/incident_guides.html.
- 16.4 *Multi-Agency Radiological Laboratory Analytical Protocols Manual (MARLAP)*. 2004. EPA 402-B-1304 04-001A, July. Volume I, Chapters 6, 7, 20, Glossary; Volume II and Volume III, Appendix G. Available at: www.epa.gov/radiation/marlap/index.html.
- 16.5 ASTM D7282 "Standard Practice for Set-up, Calibration, and Quality Control of Instruments Used for Radioactivity Measurements," ASTM Book of Standards 11.02, current version, ASTM International, West Conshohocken, PA.
- 16.6 S. Purkl and A. Eisenhauer (2003). "A Rapid Method for Alpha-Spectrometric Analysis of Radium Isotopes in Natural Waters Using Ion-Selective Membrane Technology." *Applied Radiation and Isotopes* 59(4):245-54.

Radium-226 in Water: Rapid Radiochemical Method for High-Activity Samples

17 Tables, Diagrams, and Flow Charts

17.1 Tables [including major radiation emissions from all radionuclides separated]

Table 17.1 Alpha Particle Energies and Abundances of Importance

Energy (MeV)	Abundance (%)	Nuclide	Energy (MeV)	Abundance (%)	Nuclide
4.601	5.6	Ra -226	5.791	8.6	Ac -225
4.784	94.5	Ra -226	5.793	18.1	Ac -225
4.798	1.5	Th -229	5.830	50.7	Ac -225
4.815	9.3	Th -229	5.869	1.9	Bi -213
4.838	5.0	Th -229	6.002	100.0	Po -218
4.845	56.2	Th -229	6.051	25.1	Bi -212
4.901	10.2	Th -229	6.090	9.8	Bi -212
4.968	6.0	Th -229	6.126	15.1	Fr -221
4.979	3.2	Th -229	6.243	1.3	Fr -221
5.053	6.6	Th -229	6.278	16.2	Bi -211
5.434	2.2	Ra -223	6.288	99.9	Rn -220
5.449	5.1	Ra -224	6.341	83.4	Fr -221
5.489	99.9	Rn -222	6.425	7.5	Rn -219
5.540	9.0	Ra -223	6.553	12.9	Rn -219
5.580	1.2	Ac -225	6.623	83.5	Bi -211
5.607	25.2	Ra -223	6.778	100.0	Po -216
5.609	1.1	Ac -225	6.819	79.4	Rn -219
5.637	4.4	Ac -225	7.067	99.9	At -217
5.682	1.3	Ac -225	7.386	100.0	Po -215
5.685	94.9	Ra -224	7.450	98.9	Po -211
5.716	51.6	Ra -223	7.687	100.0	Po -214
5.724	3.1	Ac -225	8.376	100.0	Po -213
5.732	8.0	Ac -225	8.525	2.1	Po -212
5.732	1.3	Ac -225	11.660	96.8	Po -212
5.747	9.0	Ra -223			

- Analyte
 - ²¹⁷At (3rd progeny of ²²⁵Ra tracer)

- ²²⁹Th (Check ROI for indications of inadequate clean-up)

Includes only alpha particles with abundance > 1%.

Reference: NUDAT 2.4, Radiation Decay National Nuclear Data Center, Brookhaven National Laboratory; Available at: www.nndc.bnl.gov/nudat2/indx_dec.jsp; Queried: November 11, 2007.

17.2 Ingrowth curves and Ingrowth factors

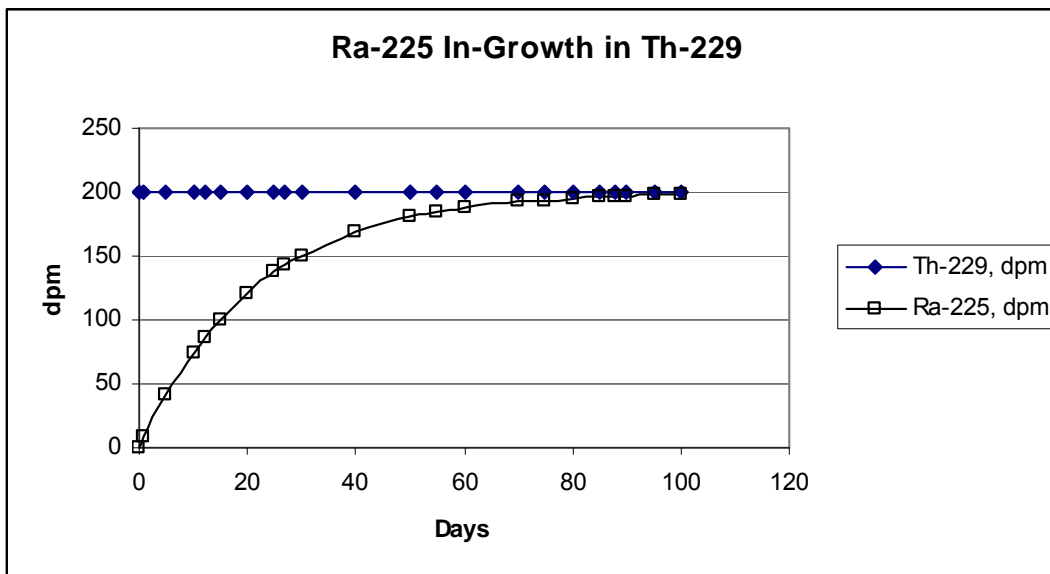
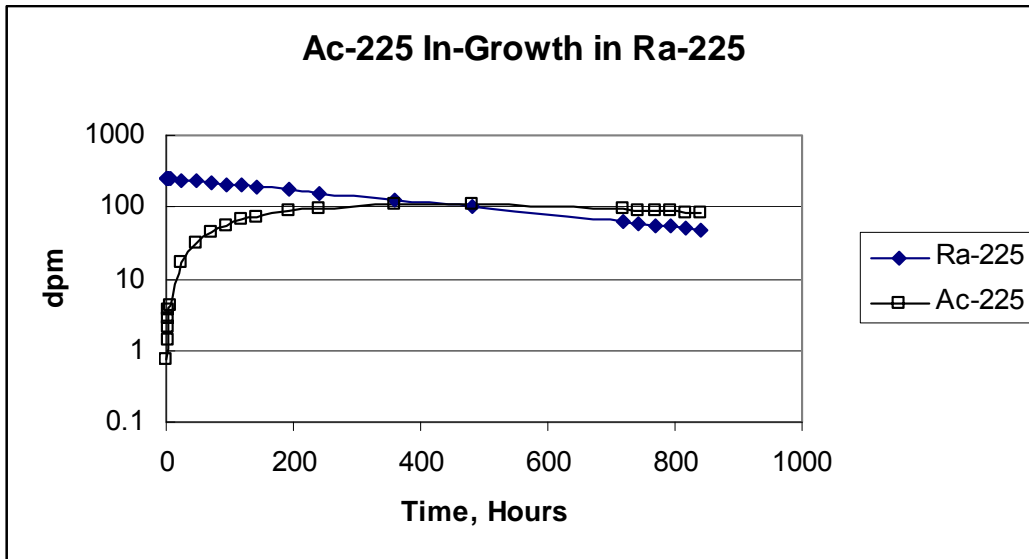

Table 17.2. Ingrowth Factors for ^{217}At in ^{225}Ra

Time elapsed between separation of Ra and midpoint of count in hours	1	2	3	4	5	6	24	48
Ingrowth Factor*	0.002881	0.005748	0.008602	0.01144	0.01427	0.01708	0.06542	0.1235
Time elapsed between separation of Ra and midpoint of count in hours	72	96	120	144	192	240	360	480
Ingrowth Factor*	0.1748	0.2200	0.2596	0.2940	0.3494	0.3893	0.4383	0.4391

*Ingrowth Factor represents the fraction of ^{217}Ac activity at the midpoint of the sample count relative to the ^{225}Ra activity present at the date/time of Ra separation. These ingrowth factors may be closely approximated (within a fraction of a percent) using the expression for A_t in Step 12.2.2.

Table 17.3 Ingrowth Factors for ^{225}Ra in ^{229}Th

Time elapsed between purification of the ^{229}Th standard and date of Ra separation in days	1	5	10	12	15	20	25	27	30	40
Ingrowth Factor*	0.04545	0.2075	0.3720	0.4278	0.5023	0.6056	0.6875	0.7152	0.7523	0.8445
Time elapsed between purification of the ^{229}Th standard and date of Ra separation in days	50	55	60	70	80	90	100	130	160	200
Ingrowth Factor*	0.9023	0.9226	0.9387	0.9615	0.9758	0.9848	0.9905	0.9976	0.9994	0.9999

*Ingrowth Factor represents the fraction ^{225}Ra activity/ ^{229}Th activity at the time of Ra separation.

Radium-226 in Water: Rapid Radiochemical Method for High-Activity Samples

Table 17.4 Decay Factors for Unsupported ^{225}Ra

Time elapsed between separation of ^{229}Th and ^{225}Ra in days	1	5	10	12	15	20	25	27	30	40
Decay Factor*	0.9545	0.7925	0.6280	0.5722	0.4977	0.3944	0.3125	0.2848	0.2477	0.1555
Time elapsed between separation of ^{229}Th and ^{225}Ra in days	50	55	60	70	80	90	100	130	160	200
Decay Factor*	0.09769	0.07741	0.06135	0.03853	0.02420	0.01519	0.00954	0.00236	0.00059	0.00009

*Decay Factor represents the fraction ^{225}Ra activity remaining.

17.3 Example Alpha Spectrum from a Processed Sample

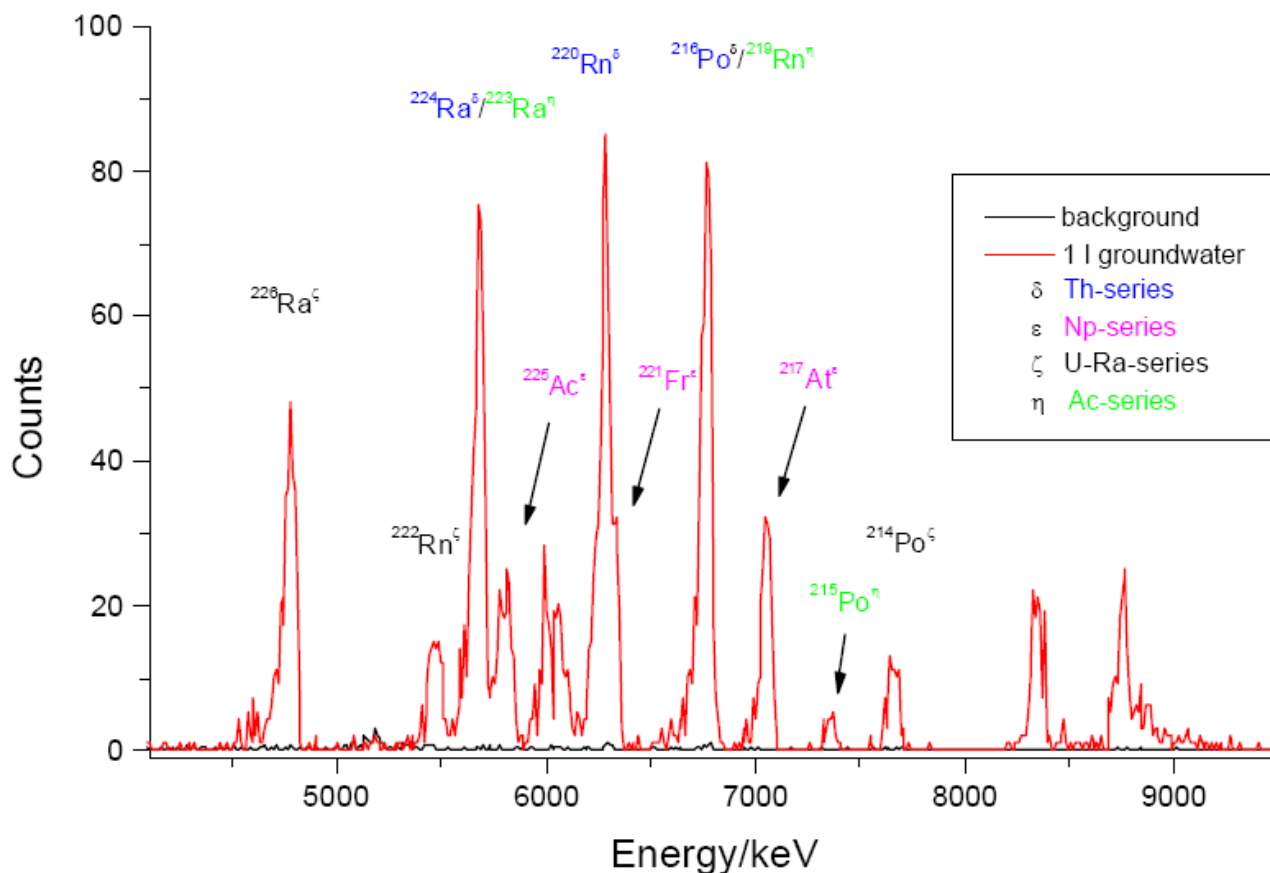

Reference: Purkl, Stefan, Dissertation: Entwicklung und Anwendung neuer analytischer Methoden zur schnellen Bestimmung von kurzlebigen Radiumisotopen und Radon im Grundwasserbeeinflussten Milieu der Ostsee; Chapter 2, Figure 3; Christian-Albrechts Universitaet, Kiel, Germany, 2003.

17.4 Decay Schemes for Analyte and Tracer

^{226}Ra Decay Scheme

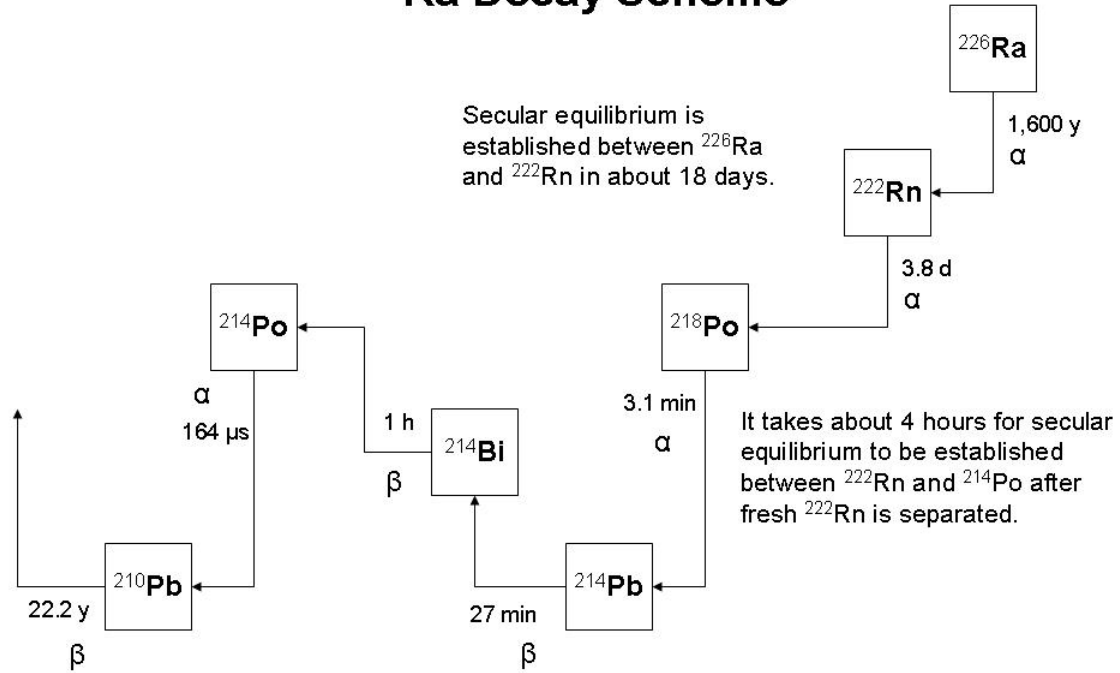

17.5 Flow chart

Note: Shaded figures are associated with the timeline.

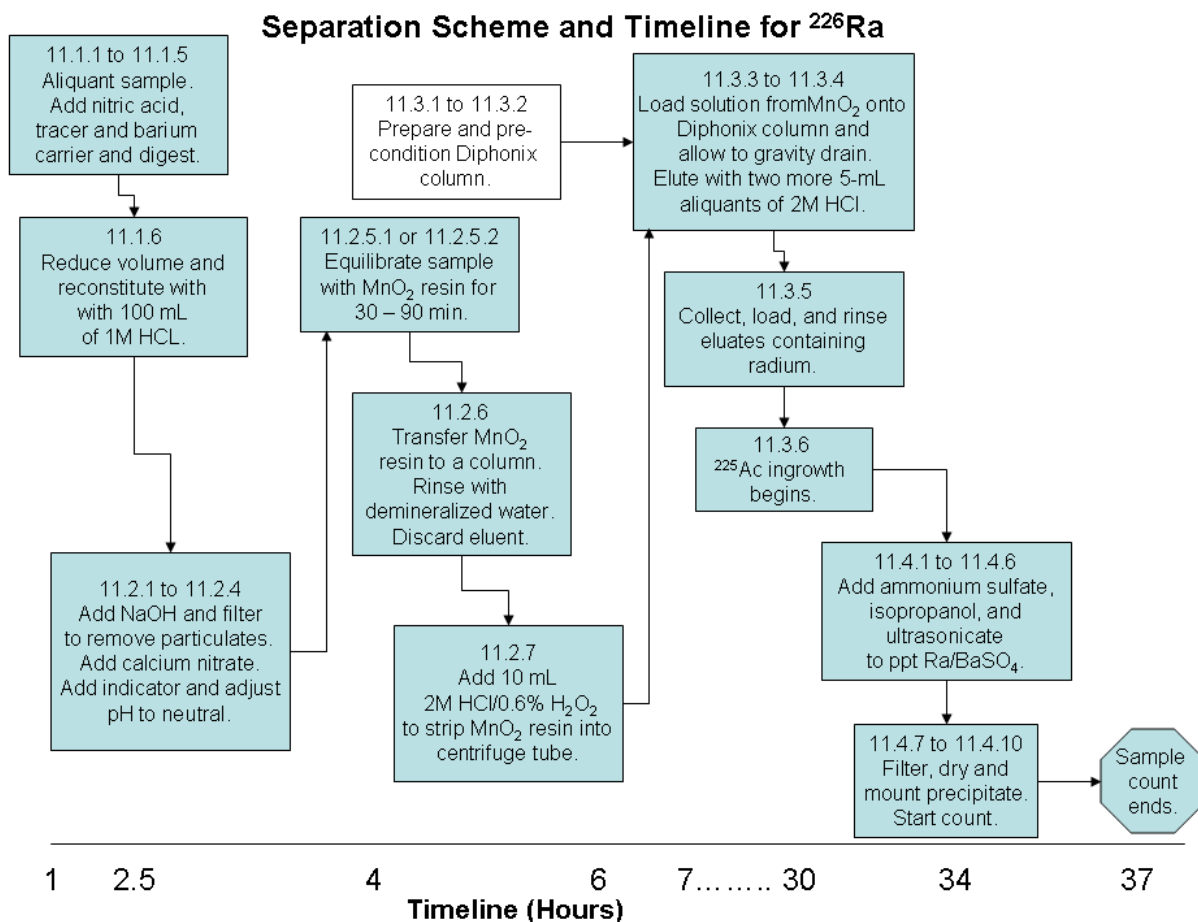

**Appendix A:
Composition of Atlanta Drinking Water Used for this Study**

Metals by ICP-AES	Concentration (mg/L)*
Silicon	3.18
Aluminum	<0.200
Barium	0.0133
Calcium	9.38
Iron	<0.100
Magnesium	<0.500
Potassium	<0.500
Sodium	<0.500
Inorganic Anions	
Chloride	12.7
Sulfate	15.6
Nitrogen, Nitrate (as N)	1.19
Carbon Dioxide	
Bicarbonate Alkalinity	23.8
Carbonate Alkalinity	<3.00
Radionuclide	Concentration (pCi/L)**
Uranium 234, 235, 238	<0.01, <0.01, <0.01
Plutonium 238, 239/240	<0.02, <0.02
Americium 241	<0.02
Strontium 90	<0.3
Radium 226***	0.11 ± 0.27 -0.30 ± 0.45

Note: Analyses conducted by independent laboratories.

- * Values below the reporting level are presented as less than (<) values. No measurement uncertainty was reported with values greater than the “Reporting Level.”
- ** Reported values represent the calculated minimum detectable concentration (MDC) for the radionuclide(s).
- *** Two samples analyzed. Expanded uncertainty (k=2) as reported by the laboratory.

Appendix B:
Preparation and Standardization of ^{225}Ra Tracer Following Separation from ^{229}Th

B1. Summary Description of Procedure

This procedure describes a ^{225}Ra generator to make tracer amounts of ^{225}Ra using a ^{229}Th solution. Th-229 is separated from ^{225}Ra using $\text{Y}(\text{OH})_3$ co-precipitation. Th-229 is carried in the precipitate and most of the ^{225}Ra remains in solution. Centrifugation to remove ^{229}Th in the precipitate and filtration of the supernate produces the ^{225}Ra tracer solution. The ^{225}Ra activity of the tracer solution is standardized by counting sample test sources prepared from at least five replicate aliquants of the ^{225}Ra solution, each spiked with a known quantity of a ^{226}Ra standard. This standardized activity concentration, referenced to the date and time of the ^{225}Ra separation described in Step 4.11.7 below, is then decay-corrected to the date and time of subsequent sample analyses.

The $\text{Y}[\text{Th}](\text{OH})_3$ precipitate may be stored and re-used later to generate more ^{225}Ra tracer solution. ^{225}Ra ingrows in the ^{229}Th fraction ($\text{Y}(\text{OH})_3$ precipitate) and after 50 days will be about 90% ingrown. After sufficient ingrowth time ^{225}Ra may be harvested to make a fresh ^{225}Ra tracer solution by dissolving the precipitate and re-precipitating $\text{Y}(\text{OH})_3$ to separate ^{229}Th from ^{225}Ra . Multiple ^{225}Ra generators may be prepared to ensure that ^{225}Ra tracer will be continuously available. The ^{225}Ra tracer solution produced is usable for 2–3 half-lives (~30–45 days). To minimize effort involved with standardization of the ^{225}Ra solution, it is recommended that the laboratory staff prepare an amount of ^{229}Th sufficient to support the laboratory's expected workload for 3–5 weeks. Since the ^{229}Th solution is reused, and the half-life of ^{229}Th is long (7,342 years), the need to purchase a new certified ^{229}Th solution is kept to a minimum.

B2. Equipment and Supplies

B2.1. Refer to Section 6 of the main procedure.

B3. Reagents and Standards

B3.1. Refer to Section 7 of the main procedure.

B4. Procedure

- B4.1. Add a sufficient amount of ^{229}Th solution (that which will yield at least 150–600 dpm/mL of the ^{225}Ra solution) to a 50-mL centrifuge tube.¹⁵
- B4.2. Add 20 mg Y (2 mL of 10 mg/mL Y metals standard stock solution).
- B4.3. Add 1 mg Ba (0.1 mL of 10 mg/mL Ba metals standard stock solution).
- B4.4. Add 4 mL of concentrated ammonium hydroxide to form $\text{Y}(\text{OH})_3$ precipitate.
- B4.5. Centrifuge and decant the supernatant into the open barrel of a 50-mL syringe, fitted with a 0.45- μm syringe filter. Hold the syringe barrel over a new 50-mL centrifuge tube while decanting. Insert the syringe plunger and filter the supernatant into the new centrifuge tube. Discard the filter as potentially contaminated rad waste.

¹⁵ For example, if 40 mL of a ^{229}Th solution of 600 dpm/mL is used, the maximum final activity of ^{225}Ra will be ~510 dpm/mL at Step B4.8. This solution would require about 1.4 mL for the standardization process and about 8 mL for a batch of 20 samples.

Radium-226 in Water: Rapid Radiochemical Method for High-Activity Samples

- B4.6. Cap the centrifuge tube with the precipitate, label clearly with the standard ID, precipitation date, and the technician's initials and store for future use.
- B4.7. Properly label the new centrifuge tube with the supernate. This is the ^{225}Ra tracer solution.
- B4.8. Add 3 mL of concentrated HCl to ^{225}Ra tracer solution. Cap centrifuge tube and mix well.
- B4.9. Prepare the following solutions in 10 mL of 2-M HCl for standardization of ^{225}Ra tracer.

<u>Solution</u>	<u>Spike(s)</u>
Standardization Replicates (5 replicates)	~80 dpm of the ^{225}Ra tracer solution, and ~8 dpm of a ^{226}Ra standard traceable to NIST or equivalent
Blank	~80 dpm of the ^{225}Ra tracer solution (<i>the blank should be evaluated to confirm that ^{226}Ra is not detected in the ^{225}Ra tracer solution at levels that may compromise sample results when used in the method</i>)
Standardization Control Sample	~80 dpm of the ^{225}Ra tracer solution, and ~8 dpm of a second source independent traceable ^{226}Ra standard (the Standardization Control Sample should be evaluated to confirm that the standardiza- tion process does not introduce significant bias into the standardized value for the ^{225}Ra tracer)

- B4.10. Add 75 μg Ba (0.075 mL of 1000 $\mu\text{g}/\text{mL}$ Ba) to all solutions.
- B4.11. Process the solutions to prepare sources for alpha spectrometry as follows:
- B4.11.1. Slurry ~1.0 g of Diphonix[®] resin per column in water.
- B4.11.2. Transfer the resin to 0.8 cm (I.D.) \times 4 cm columns to obtain a uniform resin bed.
- B4.11.3. Precondition the columns by passing 20 mL 2 M HCl through the columns. Discard the effluent.
- B4.11.4. Place clean 50-mL centrifuge tubes under the columns.
- B4.11.5. Load the solutions from Step B4.10 onto the columns. Collect the effluents in the 50-mL centrifuge tubes. Allow the solutions to flow by gravity.
- B4.11.6. When the load solutions have stopped flowing, rinse columns with two 5-mL volumes of 2-M HCl. Collect the rinse solutions in the same 50-mL centrifuge tubes (the total volume will be about 20 mL).
- B4.11.7. Record the date and time of the last rinse as the date and time of separation of radium (beginning of ^{225}Ac ingrowth).
- B4.11.8. Add ~3.0 grams of $(\text{NH}_4)_2\text{SO}_4$ to the solutions from Step B4.11.6. Mix gently to dissolve.
- B4.11.9. Add 5.0 mL of isopropanol and mix gently.

- B4.11.10. Place in an ultrasonic bath filled with cold tap water for at least 20 minutes.
- B4.11.11. Filter the suspensions through pre-wetted (using methanol or ethanol) 0.1- μm filters.
- B4.11.12. Rinse the filters with three 2-mL portions of 20% isopropanol. Allow each rinse to completely pass through filter before adding the next rinse.
- B4.11.13. Rinse each filter with about 2 mL of methanol or ethanol.
- B4.11.14. Carefully place each filter face-side up on a labeled stainless steel planchet, or other suitable source mount, which has previously been prepared with an appropriate adhesive (e.g., double stick tape).
- B4.11.15. Dry under a heat lamp for a few minutes.
- B4.11.16. After allowing about 24-hours ingrowth, count the standardization sources by alpha spectrometry.
- B4.12. Calculate the activity of ^{225}Ra , in units of dpm/mL, in the standardization replicates, at the ^{225}Ra time of separation as follows:

$$A_{^{225}\text{Ra}} = \frac{\left(\frac{N_{^{217}\text{At}}}{t_{^{217}\text{At}}} - \frac{N_b}{t_b} \right) \times (A_{^{226}\text{Ra}}) \times (V_{^{226}\text{Ra}})}{\left(\frac{N_{^{226}\text{Ra}}}{t_a} - \frac{N_b}{t_b} \right) \times \left[(3.0408)(I_t) (e^{-\lambda_1 d} - e^{-\lambda_2 d}) \right] \times V_{^{225}\text{Ra}}}$$

where:

- $A_{^{225}\text{Ra}}$ = Activity concentration of ^{225}Ra , in dpm/mL [at the time of separation from ^{229}Th , Step B4.11.7]
- $N_{^{217}\text{At}}$ = Total counts beneath the ^{217}At peak at 7.07 MeV
- $N_{^{226}\text{Ra}}$ = Total counts beneath the ^{226}Ra peak at 4.78 MeV
- N_b = Background count rate for the corresponding region of interest,
- t_a = Duration of the count for the sample test source, minutes
- t_b = Duration of the background count, minutes
- $A_{^{226}\text{Ra}}$ = Activity of ^{226}Ra added to each aliquant, in dpm/mL
- $V_{^{226}\text{Ra}}$ = volume of ^{226}Ra solution taken for the analysis (mL)
- $V_{^{225}\text{Ra}}$ = volume of ^{225}Ra solution taken for the analysis (mL)
- d = Elapsed ingrowth time for ^{225}Ac [and the progeny ^{217}At], from separation to the midpoint of the sample count, days
- λ_1 = 0.04652 d^{-1} (decay constant for ^{225}Ra – half-life = 14.9 days)
- λ_2 = 0.06931 d^{-1} (decay constant for ^{225}Ac – half-life = 10.0 days)
- I_t = Fractional abundance for the 7.07 MeV alpha peak counted (= 0.9999)
- 3.0408 = $\lambda_2 d / (\lambda_2 d - \lambda_1 d)$ [a good approximation as the half lives of ^{221}Fr and ^{217}At are short enough so secular equilibrium with ^{225}Ac is ensured]

Note: The activity of the separated $A_{^{225}\text{Ra}}$ will need to be decay corrected to the point of separation in the main procedure (Step 11.3.6) so that the results can be accurately determined.

B4.13. Calculate the uncertainty of the activity concentration of the ^{225}Ra tracer at the reference date/time:

$$u_c(AC_{^{225}\text{Ra}}) = \sqrt{\frac{\left(\frac{N_{^{217}\text{At}}}{t_a} + \frac{N_b}{t_b}\right) \times AC_{^{226}\text{Ra}}^2 \times I_{^{226}\text{Ra}}^2 \times V_{^{226}\text{Ra}}^2}{\left(\frac{N_{^{226}\text{Ra}}}{t_a} - \frac{N_b}{t_b}\right)^2 \times [3.0408 \times I_{^{217}\text{At}} \times (e^{-\lambda_1 d} - e^{-\lambda_2 d})]^2 \times V_{^{225}\text{Ra}}^2} + AC_{^{225}\text{Ra}}^2 \times \left(\frac{u^2(AC_{^{226}\text{Ra}})}{AC_{^{226}\text{Ra}}^2} + \frac{u^2(V_{^{225}\text{Ra}})}{V_{^{225}\text{Ra}}^2} + \frac{u^2(V_{^{226}\text{Ra}})}{V_{^{226}\text{Ra}}^2} + \frac{u^2(R_{^{226}\text{Ra}})}{R_{^{226}\text{Ra}}^2}\right)}$$

where:

- $u(AC_{^{225}\text{Ra}})$ = Standard uncertainty of the activity concentration of ^{225}Ra , in dpm/mL
- $N_{^{217}\text{At}}$ = Total counts beneath the ^{217}At peak at 7.07 MeV,
- $N_{^{226}\text{Ra}}$ = Total counts beneath the ^{226}Ra tracer peak at 4.78 MeV
- N_b = Background count rate for the corresponding region of interest,
- t_a = Duration of the count for the sample test source, minutes
- t_b = Duration of the background count, minutes
- $AC_{^{226}\text{Ra}}$ = Activity of ^{226}Ra added to each aliquant, in dpm/mL
- $u(AC_{^{226}\text{Ra}})$ = Activity of ^{225}Ra , in dpm/mL
- $V_{^{226}\text{Ra}}$ = Volume of ^{226}Ra solution taken for the analysis (mL)
- $u(V_{^{226}\text{Ra}})$ = Volume of ^{226}Ra solution taken for the analysis (mL)
- $I_{^{226}\text{Ra}}$ = Fractional abundance for the ^{226}Ra peak at 4.78 MeV (= 1.000)
- $V_{^{225}\text{Ra}}$ = Volume of ^{225}Ra solution taken for the analysis (mL)
- $u(V_{^{225}\text{Ra}})$ = Volume of ^{225}Ra solution taken for the analysis (mL)
- d = Elapsed ingrowth time for ^{225}Ac [and the progeny ^{217}At], from separation to the midpoint of the sample count, days
- λ_1 = 0.04652 d^{-1} (decay constant for ^{225}Ra – half-life = 14.9 days)
- λ_2 = 0.06931 d^{-1} (decay constant for ^{225}Ac) – half-life = 10.0 days)
- $I_{^{225}\text{Ra}}$ = Fractional abundance for the 7.07 MeV alpha peak counted (= 0.9999)
- 3.0408 = $\lambda_2 d / (\lambda_2 d - \lambda_1 d)$ [a good approximation as the half lives of ^{221}Fr and ^{217}At are short enough so secular equilibrium with ^{225}Ac is ensured]
- $u(R_{^{226}\text{Ra}})$ = Standard uncertainty of net count rate for ^{226}Ra , in cpm
- $R_{^{226}\text{Ra}}$ = Net count rate for ^{226}Ra , in (cpm)

Note: The uncertainty of half-lives and abundance values are a negligible contributor to the combined uncertainty and are considered during the evaluation of combined uncertainty.

B4.14. Calculate the mean and standard deviation of the mean (standard error) for the replicate determinations, to determine the acceptability of the tracer solution for use. The calculated standard deviation of the mean should be equal to or less than 5% of the calculated mean value.

B4.15. Store the centrifuge tube containing the $\text{Y}(\text{OH})_3/\text{Th}(\text{OH})_4$ precipitate. After sufficient time has elapsed a fresh ^{225}Ra tracer solution may be generated by dissolving the precipitate with 40 mL of 0.5-M HNO_3 and repeating Steps B4.3 through B4.9 of this Appendix.

www.epa.gov
February 2010
Revision 0

Rapid Radiochemical Method for Total Radiostrontium (Sr-90) In Water for Environmental Restoration Following Homeland Security Events

U.S. Environmental Protection Agency

**Office of Air and Radiation
Office of Radiation and Indoor Air
National Air and Radiation Environmental Laboratory
Montgomery, AL 36115**

**Office of Research and Development
National Homeland Security Research Center
Cincinnati, OH 45268**

**TOTAL RADIOSTRONTIUM (SR-90) IN WATER:
RAPID METHOD FOR HIGH-ACTIVITY SAMPLES**

1. Scope and Application

- 1.1. The method will be applicable to samples where the source of the contamination is either from known or unknown origins. If any filtration of the sample is performed prior to starting the analysis, those solids should be analyzed separately. The results from the analysis of these solids should be reported separately (as a suspended activity concentration for the water volume filtered), but identified with the filtrate results.
- 1.2. The method provides a very rapid non-radioisotope-specific screen for total radiostrontium in drinking water and other aqueous samples.
- 1.3. This method uses rapid radiochemical separations techniques for the determination of beta-emitting strontium radioisotopes in water samples following a nuclear or radiological incident. Although this method can detect concentrations of ^{90}Sr on the same order of magnitude as methods used for the Safe Drinking Water Act (SDWA), this method is not a substitute for SDWA-approved methods for radiostrontium.
- 1.4. The method is capable of satisfying a required method uncertainty for ^{90}Sr (total as ^{90}Sr) of 1.0 pCi/L at an analytical action level of 8.0 pCi/L. To attain the stated measurement quality objectives (MQOs) (see Step 9.2), a sample volume of approximately 500 mL and a count time of approximately 1.25 hours are recommended. The sample turnaround time and throughput may vary based on additional project MQOs, the time for analysis of the final counting form and initial sample volume. The method must be validated prior to use following the protocols provided in *Method Validation Guide for Qualifying Methods Used by Radiological Laboratories Participating in Incident Response Activities* (EPA 2009, reference 16.3).
- 1.5. This method is intended to be used for water samples that are similar in composition to drinking water. The rapid ^{90}Sr method was evaluated following the guidance presented for “Level E Method Validation: Adapted or Newly Developed Methods, Including Rapid Methods” in *Method Validation Guide for Qualifying Methods Used by Radiological Laboratories Participating in Incident Response Activities* (EPA 2009, reference 16.3) and Chapter 6 of *Multi-Agency Radiological Laboratory Analytical Protocols Manual* (MARLAP 2004, reference 16.4). The matrix used for the determination of ^{90}Sr was drinking water from Atlanta, GA. See Appendix C of this method for a listing of the chemical constituents of the water. Multi-radionuclide analysis using sequential separation may be possible.
- 1.6. This method is applicable to the determination of soluble radiostrontium. This method is not applicable to the determination of strontium isotopes contained in highly insoluble particulate matter possibly present in water samples contaminated as a result of a radiological dispersal device (RDD) event.
- 1.7. Sequential, multi-radionuclide analysis may be possible by using this method in conjunction with other rapid methods.

2. Summary of Method

- 2.1. Strontium is isolated from the matrix and purified from potentially interfering radionuclides and matrix constituents using a strontium-specific, rapid chemical

separation method. The sample is equilibrated with strontium carrier, and concentrated by Sr/BaCO₃ coprecipitation. If insoluble residues are noted during acid dissolution steps, the residue and precipitate mixture is digested in 8 M HNO₃ to solubilize strontium. The solution is passed through a Sr-ResinTM extraction chromatography column¹ that selectively retains strontium while allowing most interfering radionuclides and matrix constituents to pass through to waste. If present in the sample, residual plutonium and several interfering tetravalent radionuclides are stripped from the column using an oxalic/nitric acid rinse. Strontium is eluted from the column with 0.05 M HNO₃ and taken to dryness in a tared, stainless steel planchet. The planchet containing the strontium nitrate precipitate is weighed to determine the strontium yield.

- 2.2. The sample test source is promptly counted on a gas flow proportional counter to determine the beta emission rate, which is used to calculate the total radiostrontium activity.
 - 2.2.1. This test assumes that it is reasonable to assume the absence of ^{89}Sr in the sample. In such cases, a total radiostrontium analysis will provide for a specific determination of ^{90}Sr in the sample. The same prepared sample test source can be recounted after ~1–21 days to verify the total radiostrontium activity. If the initial and second counts agree, this is an indication that ^{89}Sr is not present in significant amounts relative to ^{90}Sr (within the uncertainty of the measurement).
 - 2.2.2. Computational methods are available for resolving the concentration of ^{89}Sr and ^{90}Sr from two sequential counts of the sample. An example of an approach that has been used successfully at a number of laboratories is presented in Appendix B to this method. It is the responsibility of the laboratory, however, to validate this approach prior to its use.

3. Definitions, Abbreviations, and Acronyms

- 3.1. Analytical Protocol Specification (APS). The output of a directed planning process that contains the project's analytical data needs and requirements in an organized, concise form.
- 3.2. Analytical Action Level (AAL). The term analytical action level is used to denote the value of a quantity that will cause the decisionmaker to choose one of the alternative actions.
- 3.3. Analytical Decision Level (ADL). The analytical decision level refers to the value that is less than the AAL based on the acceptable error rate and the required method uncertainty.
- 3.4. Discrete Radioactive Particles (DRPs or "hot particles"). Particulate matter in a sample of any matrix where a high concentration of radioactive material is contained in a tiny particle (μm range).
- 3.5. *Multi-Agency Radiological Analytical Laboratory Protocol Manual* (see Reference 16.4.)

¹ Sr-ResinTM is a proprietary extraction chromatography resin consisting of octanol solution of 4,4'(5')-bis (t-butyl-cyclohexano)-18-crown-6-sorbed on an inert polymeric support. The resin can be employed in a traditional chromatography column configuration (gravity or vacuum) or in a flow cartridge configuration designed for use with vacuum box technology. Sr-Resin is available from Eichrom Technologies, Lisle, IL.

- 3.6. Measurement Quality Objective (MQO). MQOs are the analytical data requirements of the data quality objectives and are project- or program-specific. They can be quantitative or qualitative. MQOs serve as measurement performance criteria or objectives of the analytical process.
 - 3.7. Radiological Dispersal Device (RDD), i.e., a “dirty bomb.” This is an unconventional weapon constructed to distribute radioactive material(s) into the environment either by incorporating them into a conventional bomb or by using sprays, canisters, or manual dispersal.
 - 3.8. Required Method Uncertainty (u_{MR}). The required method uncertainty is a target value for the individual measurement uncertainties and is an estimate of uncertainty (of measurement) before the sample is actually measured. The required method uncertainty is applicable below an AAL.
 - 3.9. Relative Required Method Uncertainty (ϕ_{MR}). The relative required method uncertainty is the u_{MR} divided by the AAL and is typically expressed as a percentage. It is applicable above the action level.
 - 3.10. Sample Test Source (STS). This is the final form of the sample that is used for nuclear counting. This form is usually specific for the nuclear counting technique in the method, such as a solid deposited on a filter for alpha spectrometry analysis.
 - 3.11. Total Radiostrontium (also called Total Strontium): A radiological measurement that does not differentiate between ⁸⁹Sr and ⁹⁰Sr. The assumption is that all of the strontium is in the form of ⁹⁰Sr. When it is certain that no ⁸⁹Sr is present, the total radiostrontium activity is equal to the ⁹⁰Sr activity and may be reported as such.
4. Interferences
 - 4.1. Radiological
 - 4.1.1. Count results should be monitored for detectable alpha activity and appropriate corrective actions taken when observed. Failure to address the presence of alpha emitters in the sample test source may lead to high result bias due to alpha-to-beta crosstalk.
 - 4.1.1.1. Elevated levels of radioisotopes of tetravalent plutonium, neptunium, cerium, and ruthenium in the sample may hold up on the column and co-elute with strontium. The method employs an oxalic acid rinse that should address low to moderate levels of these interferences in samples.
 - 4.1.1.2. The resin has a higher affinity for polonium than strontium. Under the conditions of the analysis, however, polonium is not expected to elute from the column.
 - 4.1.2. Significant levels of ⁸⁹Sr in the sample will interfere with the total radiostrontium analysis.
 - 4.1.2.1. The absence of higher levels of interfering ⁸⁹Sr may be detected by counting the sample test source quickly after initial separation (minimizing ingrowth of ⁹⁰Y), and then recounting the sample test source after 1–21 days to verify that the calculated activity does not change significantly. The presence of ⁸⁹Sr may be indicated when the calculated activity of the second count is less than that of the first

count by an amount greater than that which can be attributed to statistical variation in the two analyses.

- 4.1.2.2. Alternatively, Appendix B provides a numerical approach for the isotopic determination ⁸⁹Sr and ⁹⁰Sr from two sequential counts of the sample, one immediately following separation, and one after a delay to allow for ingrowth of ⁹⁰Y and decay of ⁸⁹Sr. Note that the approach in Appendix B must be validated prior to use.
- 4.1.3. High levels of ²¹⁰Pb may interfere with low-level strontium analysis due to ingrowth of short-lived ²¹⁰Bi during chemical separations. If ²¹⁰Pb is known to be present in samples, minimizing the time between the final rinse and the elution of strontium to less than 15 minutes will maintain levels of interfering ²¹⁰Bi to less than 0.1% of the ²¹⁰Pb activity present. The presence or absence of interfering ²¹⁰Bi may be determined by recounting the sample test source to verify the half-life of the nuclide present.
- 4.1.4. High levels of ²²⁸Th or its decay progeny ²²⁴Ra and ²¹²Pb may interfere with low-level strontium determinations due to ingrowth of short-lived decay products during chemical separations. Monitoring count data for alpha activity may provide indications of interferences. Minimizing the time between the final rinse and the elution of strontium from the column to 5 minutes should maintain levels of interfering ²¹²Pb and ²⁰⁸Tl to less than 2% of the parent nuclide activity. The presence or absence of ²¹²Pb may be determined by recounting the sample test source to verify the half-life of the nuclide present.
- 4.1.5. Levels of radioactive cesium or cobalt in excess of approximately 10³ times the activity of strontium being measured may not be completely removed and may interfere with final results.
- 4.2. Non-Radiological
 - 4.2.1. Chemical yield results significantly greater than 100% may indicate the presence of non-radioactive strontium native to the sample. If the quantity of native strontium in the sample aliquant exceeds ~5% of the expected strontium carrier mass, chemical yield measurements will be affected and chemical yield corrections lead to low result bias unless the native strontium is accounted for in the yield calculations. When problematic levels of strontium are encountered, the native strontium content of the sample can be determined by an independent spectrometric measurement (such as inductively coupled plasma atomic emission spectroscopy [ICP-AES] or atomic absorption spectroscopy [AAS], etc). If the laboratory does not have access to instrumentation processing a split of the sample without the addition of strontium carrier may be used to obtain an estimate of the native strontium content of the sample.
 - 4.2.2. Sr-Resin™ has a greater affinity for lead than for strontium. Lead will quantitatively displace strontium from the column when the two are present in combined amounts approaching or exceeding the capacity of the column. If the combined quantity of lead and strontium carrier in the sample exceeds the capacity of the column, decreased strontium yields will be observed. Decreasing the sample size will help address samples with elevated levels of lead.

4.2.3. High levels of calcium, barium, magnesium, or potassium may compete with strontium for uptake on the resin leading to low chemical yield. One should consider that yield results will overestimate the true strontium yield and cause a low result bias if these interfering matrix constituents are present as significant contaminants in the final sample test source.

5. Safety

5.1. General

5.1.1. Refer to your safety manual for concerns of contamination control, personal exposure monitoring and radiation dose monitoring.

5.1.2. Refer to the laboratory chemical hygiene plan for general chemical safety rules

5.2. Radiological

5.2.1. Hot Particles (DRPs)

5.2.1.1. Hot particles, also termed “discrete radioactive particles” (DRPs), will be small, on the order of 1 mm or less. Typically, DRPs are not evenly distributed in the media and their radiation emissions are not uniform in all directions (anisotropic). Filtration using a 0.45- μm or finer filter will minimize the presence of these particles.

5.2.1.2. Care should be taken to provide suitable containment for filter media used in the pretreatment of samples that may have DRPs, because the particles become highly statically charged as they dry out and will “jump” to other surfaces causing contamination.

5.2.1.3. Filter media should be individually surveyed for the presence of these particles, and this information reported with the final sample results.

5.2.2. For samples with detectable activity concentrations of these radionuclides, labware should be used only once due to potential for cross contamination.

5.3. Procedure-Specific Non-Radiological Hazards:

None noted.

6. Equipment and supplies

6.1. Analytical balance with 0.0001-g readability or better.

6.2. Centrifuge able to accommodate 250-mL flasks and 50-mL centrifuge tubes.

6.3. Centrifuge flasks, 250 mL, disposable.

6.4. Centrifuge tubes, 50 mL, disposable.

6.5. Low background gas flow proportional counter.

6.6. Stainless steel planchets or other sample mounts: ~2-inch diameter.

6.7. Vacuum box may be procured commercially, or constructed. Setup and use should be consistent with manufacturer instructions or laboratory SOP.

6.8. Vacuum pump or laboratory vacuum system.

7. Reagents and Standards:

Note: All reagents are American Chemical Society (ACS) reagent grade or equivalent unless otherwise specified.

Total Radiostrontium (^{90}Sr) in Water: Rapid Method for High-Activity Samples

Note: Unless otherwise indicated, all references to water should be understood to mean Type I Reagent water (ASTM D1193).

- 7.1. Barium carrier solution (10 mg Ba/mL, standardization not required): Dissolve 19 g $\text{Ba}(\text{NO}_3)_2$ in water add 20 mL concentrated HNO_3 and dilute to 1 L with water.
- 7.2. Ethanol, reagent 95% ($\text{C}_2\text{H}_5\text{OH}$), available commercially.
- 7.3. Nitric Acid, HNO_3 (15.8M), concentrated, available commercially.
 - 7.3.1. Nitric acid (8 M): Add 506 mL of concentrated HNO_3 to 400 mL of water and dilute to 1 L with water.
 - 7.3.2. Nitric acid (3 M): Add 190 mL of concentrated HNO_3 to 800 mL of water and dilute to 1 L with water.
 - 7.3.3. Nitric acid (0.1 M): Add 6.3 mL of concentrated HNO_3 to 900 mL of water and dilute to 1 L with water.
 - 7.3.4. Nitric acid (0.05 M): Add 3.2 mL of concentrated HNO_3 to 900 mL water. Dilute to 1 L with water.
- 7.4. Nitric acid (3M)/oxalic acid solution (0.05 M): Add 190 mL of concentrated HNO_3 (7.3) and 6.3 grams of oxalic acid dihydrate ($\text{C}_2\text{H}_2\text{O}_4 \cdot 2\text{H}_2\text{O}$), to 800 mL of demineralized water and dilute to 1 L with de-ionized water.
- 7.5. Sodium carbonate (2 M): Dissolve 212 g anhydrous Na_2CO_3 in 800 mL of water, then dilute to 1 L with water.
- 7.6. Sodium hydroxide (12 M): Dissolve 480 g of sodium hydroxide (NaOH) in 500 mL of water and dilute the solution to 1 L in water.

Caution: The dissolution of NaOH is strongly exothermic. Take caution to prevent boiling when preparing this solution. Use of a magnetic stirrer is recommended. Allow to cool prior to use.

- 7.7. Sr-Resin[™] columns,² ~0.7 g resin, small particle size (50–100 μm), in appropriately sized column or pre-packed cartridge.
- 7.8. Strontium carrier solution, 5.00 mg/mL in 0.1-M HNO_3 , traceable to a national standards body such as NIST or standardized at the laboratory by comparison to independent standards.
 - 7.8.1. Option 1: Dilute elemental strontium standard to a concentration of 5.00 mg/mL (or mg/g) in 0.1-M HNO_3 .
 - 7.8.2. Option 2: To 200 mL de-ionized water, add 6.3 mL HNO_3 and approximately 12.07 g of strontium nitrate ($\text{Sr}(\text{NO}_3)_2$ dried to constant mass and the mass being determined to at least 0.001 g). Dilute to 1000 mL with water. Calculate the amount of strontium nitrate/mL actually present and verify per Step 7.8.3.
 - 7.8.3. Prior to use, verify the strontium carrier solution concentration as by transferring at least five 1.00-mL portions of the carrier to tared stainless steel planchets. Evaporate to dryness on a hotplate or under a heat lamp using the same technique as that used for samples. Cool in a desiccator and weigh as the nitrate to the nearest 0.1 mg. The relative standard deviation for replicates

² Available from Eichrom Technologies, Inc., Lisle IL.

should be less than 5% and the average residue mass within 5% of the expected value.

- 7.9. ^{90}Sr standard solution (carrier free), traceable to a national standards body such as NIST, in 0.5 M HNO_3 solution.

8. Sample Collection, Preservation and Storage

- 8.1. Samples should be collected in 1-L plastic containers.
- 8.2. No sample preservation is required if sample analysis is initiated within 3 days of sampling date/time.
- 8.3. If the sample is to be held for more than three days, HNO_3 shall be added until $\text{pH} < 2$.
- 8.4. If the dissolved concentration of strontium is sought, the insoluble fraction must be removed by filtration before preserving with acid.

9. Quality Control

- 9.1. Batch quality control results shall be evaluated and meet applicable Analytical Project Specifications (APS) prior to release of unqualified data. In the absence of project-defined APS or a project-specific quality assurance project plan (QAPP), the quality control sample acceptance criteria defined in the laboratory quality manual and procedures shall be used to determine acceptable performance for this method.
 - 9.1.1. A laboratory control sample (LCS) shall be run with each batch of samples. The concentration of the LCS should be at or near the action level or a level of interest for the project.
 - 9.1.2. One method blank shall be run with each batch of samples. The laboratory blank should consist of laboratory water.
 - 9.1.3. One laboratory duplicate shall be run with each batch of samples. The laboratory duplicate is prepared by removing an aliquant from the original sample container.
 - 9.1.4. A matrix spike sample may be included as a batch quality control sample if there is concern that matrix interferences, such as the presence of elemental strontium in the sample, may compromise chemical yield measurements, or overall data quality.
- 9.2. This method is capable of achieving a u_{MR} of 1.0 pCi/L at or below an action level of 8.0 pCi/L. This may be adjusted if the event-specific MQOs are different.
- 9.3. This method is capable of achieving a ϕ_{MR} 13% above 8 pCi/L. This may be adjusted if the event-specific MQOs are different.
- 9.4. This method is capable of achieving a required minimum detectable concentration (MDC) of 1.0 pCi/L.

10. Calibration and Standardization

- 10.1. The effective detection efficiency for total radiostrontium (referenced to ^{90}Sr) is calculated as the weighted sum of the ^{90}Sr and ^{90}Y efficiencies that reflects the relative proportions of ^{90}Y and ^{90}Sr based on the ^{90}Y ingrowth after ^{90}Sr separation.
- 10.2. Set up, operate, and perform quality control for gas-flow proportional counters (GPC) in accordance with the laboratory's quality manual and standard operating procedures,

and consistent with ASTM Standard Practice D7282, Sections 7-13 (see reference 16.5).

- 10.3. See Appendix A for details on calibration/standardization of the GPC specific to ⁹⁰Sr and ⁹⁰Y.

11. Procedure

- 11.1. For each sample in the batch, aliquant 0.5 L of raw or filtered water into a beaker. Add concentrated HNO₃ with mixing to bring the solution to a pH less than 2.0.

Note: Smaller or larger aliquants may be used if elevated sample activity is present or as needed to meet detection requirements or MQOs. Method validations must be conducted using a volume equivalent in size to the sample size to be used.

- 11.2. Add 1.00 mL (using a volumetric pipette) of 5 mg/mL strontium carrier and 0.5 mL barium carrier. Record the volume of strontium carrier added and the associated uncertainty of the mass of strontium added.
- 11.3. Place the beaker on a hotplate (for aliquants of 0.2 L a centrifuge cone in a hot water bath may also be used) and heat the solution to near boiling with occasional stirring.
- 11.4. Add ~0.4–0.5 mL (8–10 drops) 0.1% phenolphthalein indicator solution per 200 mL of sample. Add 12 M NaOH slowly with occasional stirring until a persistent pink color is obtained.

Note: Additional phenolphthalein solution may be used if needed to provide a clear indication that the pH is above ~8.3. A slight excess of NaOH may be added.

- 11.5. Add 30 mL of 2-M Na₂CO₃ to the sample and digest for 15 minutes with occasional stirring. Remove the sample from the hot plate and allow the solution to cool and the precipitate to settle.

Note: Samples may be placed in an ice bath to expedite the cooling process.

Note: If greater than a 0.2-L aliquant is used, the supernatant solution is decanted or an aspirator line used to remove as much supernatant solution as possible prior to transfer to a centrifuge tube.

- 11.6. Transfer the sample to a centrifuge tube and centrifuge for 3 to 5 minutes at 1500-2000 rpm. Discard supernatant solution.
- 11.7. Add 5 mL of 8-M HNO₃ to the centrifuge tube and vortex to dissolve the precipitate containing Sr.
- 11.8. If there are no undissolved solids visible in the sample and the sample is not from an RDD, or there is no reason to possibly suspect highly intractable material to be present (e.g., insoluble ceramics), proceed with Step 11.11.
- 11.9. If the sample contains undissolved solids or may contain intractable material, cover the tube to minimize evaporation of the solution and digest the solution on a hot water bath for 30 minutes. Allow to cool.

- 11.10. If solids persist, remove by filtering solution through a glass fiber filter (1 μm or finer). The filter containing the solids should be analyzed separately for gross beta activity (⁹⁰Sr efficiency) to determine whether the AAL may be exceeded (screening ADLs apply). The solution containing soluble strontium is retained as load solution for Step 11.13.

Note: See Section 12.3.2 for reporting results when liquid and solid fractions are analyzed separately.

- 11.11. Set up a vacuum box for Sr-Resin™ columns or cartridges with minimum 10-15 mL reservoirs according the manufacturer's instructions or laboratory SOP. The initial configuration should permit column effluents during the preconditioning, sample loading and rinses (Steps 11.12 – 11.16) to be discarded to waste.
- 11.12. Add 5 mL of 8-M HNO₃ to precondition the column. Adjust the vacuum as necessary to maintain flow rates at ≤ 3 mL/min. Discard preconditioning solution effluent.

Note: Unless otherwise specified in the procedure, use a flow rate of ~ 1 mL/min for load and strip solutions and ~ 3 mL/min for rinse solutions.

- 11.13. Decrease the vacuum to obtain flow rates of ≤ 1 mL/min. Load the sample from Step 11.8 or 11.10 into the column reservoir. When the solution reaches the top surface of the resin proceed with the next step. Discard column effluent.
- 11.14. Adjust the vacuum as necessary to maintain flow rates at ≤ 3 mL/min. Rinse centrifuge tube with three successive 3 mL portions of 8-M HNO₃ adding the next one after the previous one reaches the top of the resin column. Discard column effluent.
- 11.15. If plutonium, neptunium, or radioisotopes of ruthenium or cerium may be present in the sample, add 10 mL 3-M HNO₃ – 0.05-M oxalic acid solution to each column. Allow the solution to completely pass through the column prior to proceeding. Adjust the vacuum as necessary to maintain flow rates at ≤ 3 mL/min. Discard column effluent.
- 11.16. Remove residual nitric/oxalic acid solution with two 3 mL rinses of 8-M HNO₃, allowing each rinse solution to drain before adding the next one. Adjust the vacuum as necessary to maintain flow rates at ≤ 3 mL/min. Record time and date of the end of last rinse to the nearest 15 minutes as t_1 , "time of strontium separation." Discard column effluent.
- 11.17. Place clean 50 mL centrifuge tubes beneath the columns to catch the strontium eluate before proceeding to the next step.
- 11.18. Decrease the vacuum as necessary to maintain flow rates at ≤ 1 mL/min. Elute strontium from the columns by adding 10 mL of 0.05-M HNO₃.
- 11.19. Preparation of the STS and determination of chemical yield
- 11.19.1. Clean and label a stainless steel planchet for each STS.
- 11.19.2. Weigh and record the tare mass of each planchet to the nearest 0.1 mg.

- 11.19.3. Transfer the strontium eluate from Step 11.18 to the planchet and take to dryness on a hotplate or under a heat lamp to produce a uniformly distributed residue across the bottom of the planchet.
- 11.19.4. When dry, place the sample in an oven at 105–110 °C until shortly before sample test sources are ready for weighing. At that point, remove the STS from the oven and allow it to cool in a desiccator before weighing.
- 11.19.5. Weigh and record the gross mass of each planchet to the nearest 0.1 mg.

Note: If the laboratory cannot operationally ensure that the precipitate has been dried to constant mass, the mass stability of the precipitate should be demonstrated by reheating the precipitate in an oven at 105–110 °C and reweighing. Since sample self-attenuation is not a significant factor in the detection efficiency, the sample may be counted prior to completion of this step if desired.

- 11.19.6. Calculate the chemical yield as presented in Section 12 of this method.
- 11.20. Counting the Sample Test Source
 - 11.20.1. On a calibrated gas-flow proportional detector that has passed all required daily performance and background checks, count the STS for a period as needed to satisfy MQOs.
 - 11.20.1.1. If the presence of ⁸⁹Sr cannot be excluded, and total radiostrontium is being determined as a screen for the presence of ⁸⁹Sr or ⁹⁰Sr, count the STS as soon as practicable after preparation to minimize the ingrowth of ⁹⁰Y into the STS.
 - 11.20.1.2. If the presence of ⁸⁹Sr can be excluded, total radiostrontium will provide isotopic ⁹⁰Sr results and the STS may be counted at any time after preparation.
 - 11.20.2. Calculate the total radiostrontium (⁹⁰Sr) sample results using calculations presented in Section 12.

12. Data Analysis and Calculations

12.1. Calculation of Total Radiostrontium

- 12.1.1. When a sample is analyzed for total radiostrontium (equivalent ⁹⁰Sr), the effective efficiency is calculated as follows:

$$\epsilon_{\text{Total Sr}} = \epsilon_{\text{Sr90}} + (1 - e^{-\lambda_{\text{Y90}}(t_2 - t_1)}) \times \epsilon_{\text{Y90}} \quad (1)$$

where

- $\epsilon_{\text{Total Sr}}$ = effective detection efficiency for total radiostrontium
- ϵ_{Sr90} = final ⁹⁰Sr detection efficiency
- ϵ_{Y90} = final ⁹⁰Y detection efficiency
- λ_{Y90} = decay constant for ⁹⁰Y, $3.008 \times 10^{-6} \text{ s}^{-1}$
- t_1 = date and time of the Sr/Y separation
- t_2 = date and time of the midpoint of the count

Note: The elapsed time between the sample count and the reference date must be calculated using the same time units as the decay constant.

12.1.2. The standard uncertainty of the effective efficiency is calculated as follows:

$$u(\varepsilon_{\text{Total Sr}}) = \sqrt{u^2(\varepsilon_{\text{Sr90}}) + \left(1 - e^{-\lambda_{\text{Sr90}}(t_2-t_1)}\right)^2 u^2(\varepsilon_{\text{Y90}}) + 2\left(1 - e^{-\lambda_{\text{Sr90}}(t_2-t_1)}\right)u(\varepsilon_{\text{Sr90}}, \varepsilon_{\text{Y90}})} \quad (2)$$

where

$$u(\varepsilon_{\text{Sr90}}, \varepsilon_{\text{Y90}}) = r(\varepsilon_{\text{Sr90}}, \varepsilon_{\text{Y90}})u(\varepsilon_{\text{Sr90}})u(\varepsilon_{\text{Y90}})$$

Note: This term is derived during calibrations in Appendix A, Section 4.

12.1.3. The total radiostrontium activity concentration ($AC_{\text{Total Sr}}$) equivalent to ⁹⁰Sr is calculated as follows:

$$AC_{\text{Total Sr}} = \frac{R_a - R_b}{2.22 \times \varepsilon_{\text{Total Sr}} \times Y \times V \times DF} \quad (3)$$

where

$$DF = e^{-\lambda_{\text{Sr90}}(t_1-t_0)} \quad (4)$$

and where

- R_a = beta gross count rate for the sample (cpm)
- R_b = beta background count rate (cpm)
- $\varepsilon_{\text{Total Sr}}$ = effective efficiency of the detector for total strontium referenced to ⁹⁰Sr
- Y = fractional chemical yield for strontium
- V = volume of the sample aliquant (L)
- DF = correction factor for decay of the sample from its reference date until the midpoint of the total strontium count
- λ_{Sr90} = decay constant for ⁹⁰Sr, $7.642 \times 10^{-10} \text{ s}^{-1}$
- t_0 = reference date and time for the sample
- t_1 = date and time of the Sr/Y separation

Note: The elapsed time between the sample count and the reference date must be calculated using the same time units as the decay constant

12.1.4. The standard counting uncertainty of the total radiostrontium activity concentration, $u_{\text{cC}}(AC_{\text{Total Sr}})$ is calculated as follows:

$$u_{\text{cC}}(AC_{\text{Total Sr}}) = \frac{\sqrt{\frac{R_a}{t_a} + \frac{R_b}{t_b}}}{2.22 \times \varepsilon_{\text{Total Sr}} \times Y \times V \times DF} \quad (5)$$

where:

- t_a = Duration of the sample count (min)
- t_b = Duration of the background subtraction count (min)

12.1.5. The combined standard uncertainty (CSU) for the total radiostrontium activity concentration, $u_c(AC_{\text{Total Sr}})$, is calculated as follows:

$$u_c(AC_{\text{Total Sr}}) = \sqrt{u_{cC}^2(AC_{\text{Total Sr}}) + AC_{\text{Total Sr}}^2 \left(\frac{u^2(\varepsilon_{\text{Total Sr}})}{\varepsilon_{\text{Total Sr}}^2} + \frac{u^2(Y)}{Y^2} + \frac{u^2(V)}{V^2} \right)} \quad (6)$$

where:

$u(Y)$ = standard uncertainty of fractional chemical yield for strontium
 $u(V)$ = standard uncertainty of the volume of the sample aliquant (L)

12.1.6. If the critical level concentration (S_c) or the minimum detectable concentration (MDC) are requested (at an error rate of 5%), they can be calculated using the following equations:³

$$S_c = \frac{\left[0.4 \times \left(\frac{t_s}{t_b} - 1 \right) + 0.677 \times \left(1 + \frac{t_s}{t_b} \right) + 1.645 \times \sqrt{(R_b t_b + 0.4) \times \frac{t_s}{t_b} \times \left(1 + \frac{t_s}{t_b} \right)} \right]}{t_s \times 2.22 \times \varepsilon_{\text{Total Sr}} \times Y \times V \times DF} \quad (7)$$

$$MDC = \frac{\left[2.71 \times \left(1 + \frac{t_s}{t_b} \right) + 3.29 \times \sqrt{R_b t_s \times \left(1 + \frac{t_s}{t_b} \right)} \right]}{t_s \times 2.22 \times \varepsilon_{\text{Total Sr}} \times Y \times V \times DF} \quad (8)$$

12.2. Chemical Yield for Strontium

12.2.1. Calculate the chemical yield for strontium using the gravimetric data collected in Step 11.18:

$$Y = \frac{m_s F_{\text{Sr(NO}_3)_2}}{c_c V_c + c_n V} \quad (9)$$

where:

Y = strontium yield, expressed as a fraction
 m_s = mass of $\text{Sr(NO}_3)_2$ recovered from the sample (g)
 $F_{\text{Sr(NO}_3)_2}$ = gravimetric factor for strontium weighed as the nitrate, 414.0 mg Sr/g $\text{Sr(NO}_3)_2$
 c_c = Sr mass concentration in the strontium carrier solution (mg/mL)
 V_c = volume of strontium carrier added to the sample (mL)
 c_n = Sr mass concentration native to the sample – if determined (mg/L)
 V = volume of sample aliquant (L)

12.2.2. Calculate the standard uncertainty of the yield as follows:

³ The formulations for the critical level and minimum detectable concentration are based on the Stapleton Approximation as recommended in MARLAP Section 20A.2.2, Equations 20.54 and 20A.3.2, and Equation 20.74, respectively. The formulations presented assume $\alpha = 0.05$, $\beta = 0.05$ (with $z_{1-\alpha} = z_{1-\beta} = 1.645$), and $d = 0.4$.

$$u(Y) = Y \times \sqrt{u_r^2(m_s) + \frac{u^2(c_c)V_c^2 + c_c^2 u^2(V_c) + u^2(c_n)V^2 + c_n^2 u^2(V)}{(c_c V_c + c_n V)^2}} \quad (10)$$

where

- $u(\cdot)$ = standard uncertainty of the quantity in parentheses,
 $u_r(\cdot)$ = relative standard uncertainty of the quantity in parentheses.

12.3. Results Reporting

12.3.1. Unless otherwise specified in the APS, the following items should be reported for each result:

- 12.3.1.1. Result for total radiostrontium (Step 12.1.3) in scientific notation ± 1 combined standard uncertainty.
 12.3.1.2. Volume of sample aliquant and any dilutions used.
 12.3.1.3. Yield of tracer and its uncertainty.
 12.3.1.4. Case narrative
 12.3.1.5. The APS may specify reporting requirements for samples originating from an RDD or other event where intractable material (e.g., strontium titanate) may be present. If specific guidance is not provided, but intractable materials are likely present in samples, the results for soluble strontium (from the aqueous phase) should be reported per Step 12.3.2.

12.3.2. If solid material was filtered from the solution and analyzed separately, the gross beta results from the direct count of filtered solids should be calculated as “gross beta (⁹⁰Sr)” or “gross beta equivalent ⁹⁰Sr” and reported separately in terms of pCi/L of the original volume of sample.

For Example:

⁹⁰Sr for Sample 12-1-99:

Filtrate result: $(1.28 \pm 0.15) \times 10^1$ pCi/L

Gross beta (⁹⁰Sr) filtered residue result: $(2.50 \pm 0.30) \times 10^0$ pCi/L

13. Method Performance

13.1. Results of method validation performance are to be archived and available for reporting purposes.

13.2. Expected turnaround time per sample or per batch (See Figure 17.4 for typical processing times (assumes samples are not from RDD).

13.2.1. Preparation and chemical separations for a batch of 20 samples can be performed by using two vacuum box systems (12 ports each) simultaneously, assuming 24 detectors are available. For an analysis of a 500 mL sample aliquant, sample preparation and digestion should take ~3–4 h.

13.2.2. Purification and separation of the strontium fraction using cartridges and vacuum box system should take ~0.5–1.2 h.

13.2.3. Sample test source preparation takes ~0.75 – 1.5 h.

- 13.2.4. A 100-minute counting time is sufficient to meet the MQO listed in Step 9.2, assuming 0.5 L aliquant, a background of 1 cpm, detector efficiency of 0.3–0.4, and radiochemical yield of at least 0.5.
- 13.3. Total radiostrontium (⁹⁰Sr) data reduction should be achievable between 6 and 9 hours after the beginning of the analysis.
- 13.4. The sample may be recounted following a delay of 1–21 days to verify the radiochemical purity of ⁹⁰Sr. If the source contains pure ⁹⁰Sr, the total radiostrontium activity calculated from the two counts should agree within the uncertainty of the measurements. Minimizing the time between the chemical separation of Sr and the initial count, longer count times, and increasing the delay between the two counts, will minimize the overall uncertainty of the data and provide more sensitive and reliable measures of the radiochemical purity of the STS.

Note: The ⁸⁹Sr and ⁹⁰Sr may be determined from two consecutive counts of the source – calculations are presented in Appendix B. This approach must be validated prior to use.

14. Pollution Prevention

- 14.1. The use of Sr-Resin™ reduces the amount of acids and hazardous metals that would otherwise be needed to co-precipitate and purify the sample and prepare the final counting form.

15. Waste Management

- 15.1. Nitric acid and hydrochloric acid wastes should be neutralized before disposal and then disposed in accordance with prevailing laboratory, local, state and federal requirements.
- 15.2. Initial column effluents contain mg/mL levels of barium and should be disposed in accordance with prevailing laboratory, local, state and federal requirements.
- 15.3. Final precipitated materials may contain radiostrontium and should be treated as radioactive waste and disposed in accordance with the restrictions provided in the facility's radioactive materials license and any prevailing local restrictions.
- 15.4. Used resins and columns should be considered radioactive waste and disposed of in accordance with restriction provided in the facility's radioactive materials license and any prevailing local restrictions.

16. References

- 16.1. SRW04-11, "Strontium 89, 90 in Water," Eichrom Technologies, Inc., Lisle, Illinois (February 2003).
- 16.2. "Rapid Column Extraction Method for Actinides and 89/90Sr in Water Samples," S.L. Maxwell III. *Journal of Radioanalytical and Nuclear Chemistry* 267(3): 537-543 (Mar 2006).
- 16.3. U.S. Environmental Protection Agency (EPA). 2009. *Method Validation Guide for Radiological Laboratories Participating in Incident Response Activities*. Revision 0. Office of Air and Radiation, Washington, DC. EPA 402-R-09-006, June. Available at: www.epa.gov/narel/incident_guides.html.

- 16.4. *Multi-Agency Radiological Laboratory Analytical Protocols Manual* (MARLAP). 2004. EPA 402-B-1304 04-001A, July. Volume I, Chapters 6, 7, 20, Glossary; Volume II and Volume III, Appendix G. Available at: www.epa.gov/radiation/marlap/index.html.
- 16.5. ASTM D7282 “Standard Practice for Set-Up, Calibration, and Quality Control of Instruments Used for Radioactivity Measurements,” ASTM Book of Standards 11.02, current version, ASTM International, West Conshohocken, PA.
- 16.6. SR-04, “Radiochemical Determination of Radiostrontium in Water, Sea Water, and Other Aqueous Media,” Eastern Environmental Radiation Facility (EERF) Radiochemistry Procedures Manual, Montgomery, AL, EPA 520/5-84-006 (August 1984).
- 16.7. ASTM D1193, “Standard Specification for Reagent Water,” ASTM Book of Standards 11.02, current version, ASTM International, West Conshohocken, PA
- 16.8. Nuclear data from NUDAT 2.3 and the National Nuclear Data Center at Brookhaven National Laboratory; available at www.nndc.bnl.gov/nudat2/indx_dec.jsp, database version of 6/30/2009.

17. Tables, Diagrams, Flow Charts and Validation Data

17.1. Validation Data

This section intentionally left blank.

17.2. Nuclide Decay and Radiation Data

Table 17.1. Decay and Radiation Data

Nuclide	Half-life (days)	λ (s ⁻¹)	Abundance	β_{max} (MeV)	β_{avg} (MeV)
⁹⁰ Sr	1.052E+04	7.642×10 ⁻¹⁰	1.00	0.546 MeV	0.196 MeV
⁹⁰ Y	2.6667	3.005×10 ⁻⁶	1.00	2.280 MeV	0.934 MeV
⁸⁹ Sr	50.53	1.587×10 ⁻⁷	1.00	1.495 MeV	0.585 MeV

17.3. Ingrowth and Decay Curves and Factors

In-Growth Curve for ⁹⁰Y in ⁹⁰Sr

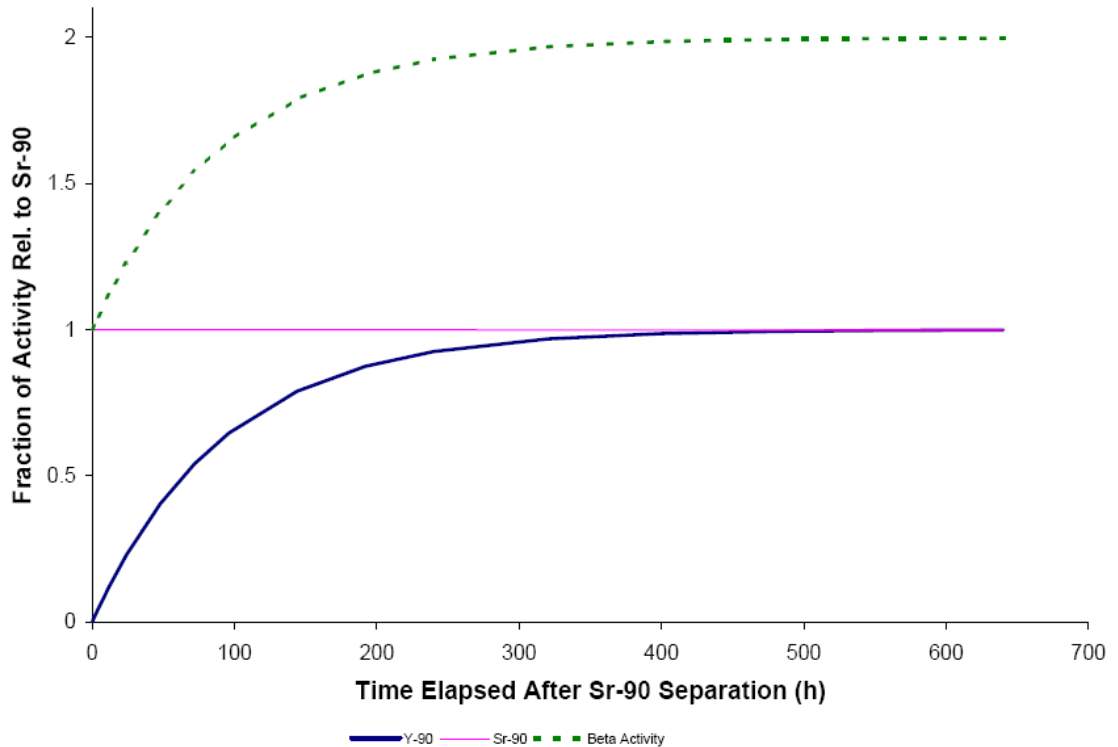

Total Radiostrontium (⁹⁰Sr) in Water: Rapid Method for High-Activity Samples

Table 17.2. Total Beta Activity Ingrowth Factors for ⁹⁰Y in ⁹⁰Sr

Ingrowth time elapsed (hours)	0.25	2	4	12	24	48	72	96
Factor	0.003	0.021	0.042	0.122	0.229	0.405	0.541	0.646
Ingrowth time elapsed (hours)	144	192	240	320	400	480	560	640
Factor	0.790	0.875	0.926	0.969	0.987	0.994	0.998	0.999

Factor = (⁹⁰Y activity/⁹⁰Sr activity at zero hours of ingrowth)

Decay Curve for ⁸⁹Sr

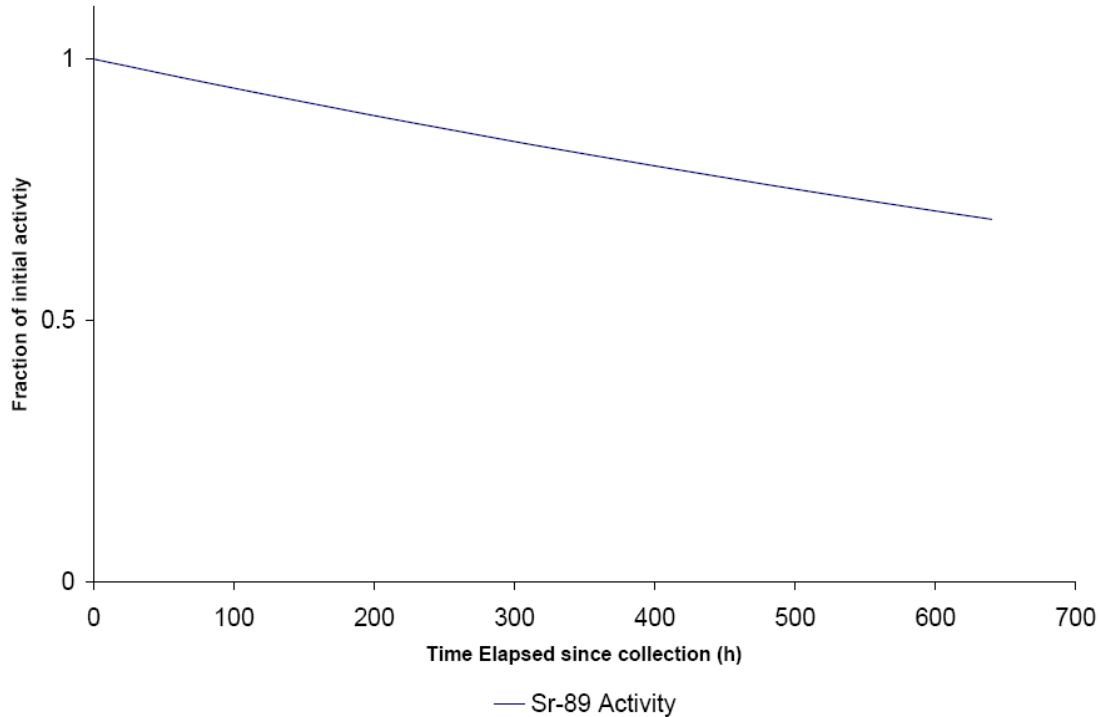

Table 17.3. Decay Factors for ⁸⁹Sr

Decay time elapsed (hours)	0.25	2	4	12	24	48	72	96
Factor	1.000	0.999	0.998	0.993	0.986	0.973	0.960	0.947
Decay time elapsed (hours)	144	192	240	320	400	480	560	640
Factor	0.921	0.896	0.872	0.833	0.796	0.760	0.726	0.694

Factor = (⁸⁹Sr activity/⁸⁹Sr activity at zero hours of ingrowth)

17.4. Decay Schemes for ^{89}Sr and ^{90}Sr

^{89}Sr and ^{90}Sr Decay Scheme

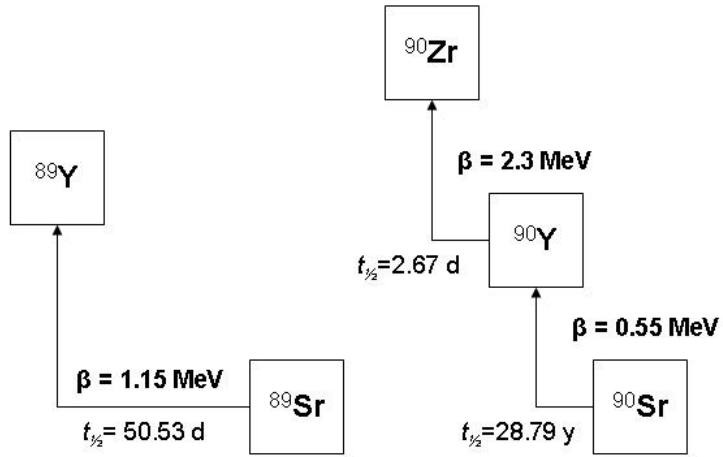

17.5. Process Flow with Typical Processing Times (assumes no filtration necessary)

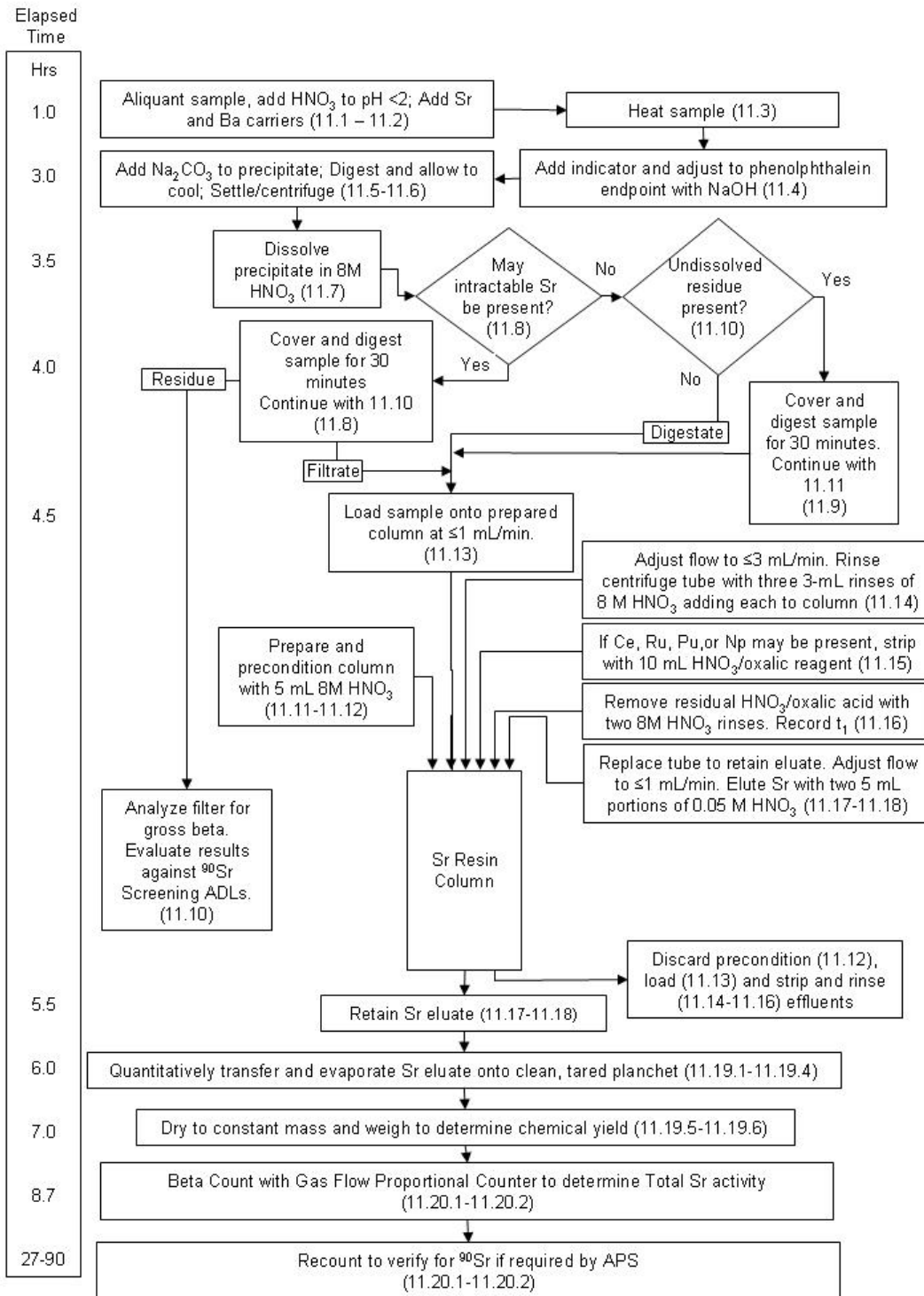

Appendix A
Method and Calculations for Detector Calibration

A1. The effective detection efficiency for total radiostrontium (referenced to ^{90}Sr) is calculated as the weighted sum of the ^{90}Sr and ^{90}Y efficiencies that reflects the relative proportions of ^{90}Y and ^{90}Sr based on the ^{90}Y ingrowth after strontium separation.

Note: While ^{89}Sr efficiency calibration is not needed unless ^{89}Sr analysis will be performed, instructions for preparation are provided to support the two count approach should this option be desired.

- A1.1. Due to the low mass of carrier used for this method, self-absorption effects may be assumed to be constant. Calibrate each detector used to count samples according to ASTM Standard Practice D7282, Section 16, “Single Point Efficiency or Constant Test Mass for a Specific Radionuclide” and the instructions below.
- A1.2. Prepare a blank and at least three working calibration sources (WCS) for ^{90}Sr and ^{90}Y , and ^{89}Sr (if needed) as follows:
 - A1.2.1. The ^{90}Sr and ^{89}Sr radioactive standard solutions used to prepare WCSs shall be traceable to a national standards body such as NIST and shall originate from a standards supplier (or lot) different from standards used for calibration verification and batch quality controls. The standards should be diluted in nitric acid.
 - A1.2.2. The planchets used for the sources shall be of the same size, materials and type as those used for the analysis of STSs.
 - A1.2.3. Preparation of ^{89}Sr WCSs (if needed): ^{89}Sr standard solution (in 0.5-M HNO_3) is evaporated to dryness in a stainless steel planchet as follows:
 - A1.2.3.1. For each ^{89}Sr WCS to be prepared, and for the associated blank, add a strontium carrier to 10 mL of 0.05-M HNO_3 in a disposable 50-mL centrifuge tube. The amount of carrier should be adjusted to approximate the amount expected to be recovered from routine samples.

Note: If the average recovery has not been determined, the laboratory may assume 85% chemical yield for determining the amount of carrier to use in Step 1.2.3.1.

Note: If the ^{89}Sr standard contains residual chloride, it will attack the surface of the planchet and compromise the quality of the calibration standard. In such cases, convert the aliquant of standard solution to a nitrate system by adding 1 mL concentrated HNO_3 and taking to dryness 2 times prior to quantitatively transferring the solution to the planchet.

- A1.2.3.2. For each WCS, add a precisely known amount of traceable ^{89}Sr solution to a 50-mL centrifuge tube. Sufficient activity must be present at the point of the count to permit accumulation of greater than 10,000 net counts in a counting period deemed to be reasonable by the laboratory. The minimum activity used,

however, should produce WCS count rates at least 20 times the background signal but not greater than 5000 cps.

- A1.2.3.3. Mix the solution and quantitatively transfer each WCS and the blank to respective clean stainless steel counting planchets using three rinses of 0.05-M HNO₃.
- A1.2.3.4. Evaporate to dryness using the same techniques used for sample test sources.
- A1.2.3.5. For each detector to be calibrated, count three ⁸⁹Sr WCSs for sufficient time to accumulate at least 10,000 net counts.

A1.3. Preparation of ⁹⁰Sr and ⁹⁰Y WCSs: Separate WCSs for ⁹⁰Sr and ⁹⁰Y are prepared by chemically separating ⁹⁰Y from a standard solution of ⁹⁰Sr.

A1.3.1. For each ⁹⁰Sr WCS to be prepared, and for the associated blank, add 1 mL of 5 mg/mL strontium carrier to a disposable 50-mL centrifuge tube. The amount of carrier added should correspond to that expected to be recovered from a routine sample.

Note: If the average recovery has not been determined, the laboratory may assume 85% chemical yield for determining the amount of carrier to use for Step 1.3.1.

A1.3.2. For each ⁹⁰Sr WCS, add a precisely known amount of traceable ⁹⁰Sr solution to a 50-mL centrifuge tube. Sufficient activity should be present at the point of the count to permit accumulation of greater than 10,000 ⁹⁰Sr and 10,000 ⁹⁰Y net counts in the respective sources in a counting period deemed to be reasonable by the laboratory. The minimum activity used, however should produce WCS count rates at least 20 times the background signal but not greater than 5000 cps.

A1.3.3. Set up one Sr Resin column for each ⁹⁰Sr WCS and for the associated blank. Condition each column with 5 mL of 3-M HNO₃. Column effluents are discarded to waste.

A1.3.4. Place a clean centrifuge tube under each column to catch all combined ⁹⁰Y effluents.

Note: Unless otherwise specified in the procedure, use a flow rate of ~ 1 mL/min for load and strip solutions and ~ 3 mL/min for rinse solutions.

A1.3.5. Load the ⁹⁰Sr solution onto the column. The load solution effluent containing ⁹⁰Y is retained.

A1.3.6. Rinse the centrifuge tube with three successive 2-mL portions of 3-M HNO₃ adding each of the rinses to the column after the previous rinse has reached the upper surface of the resin. These effluents also contain ⁹⁰Y and are retained.

A1.3.7. Rinse the column with 5 mL of 3 M HNO₃ and retain the column effluents containing ⁹⁰Y. Record the date and time that the final rinse solution leaves the column to the nearest 5 minutes as t_1 , "Time of ⁹⁰Y Separation." Remove

the centrifuge tube that has the combined ^{90}Y effluents. Place a clean tube under the column to catch the strontium eluate in subsequent steps.

NOTE: From this point, ^{90}Sr must be eluted, and the ^{90}Sr WCS must be prepared and counted as expeditiously as possible to minimize ^{90}Y ingrowth and necessary corrections to the efficiency. Counting of the ^{90}Sr WCS should be completed, if possible, within 3–5 hours but no longer than 10 hours from the time of ^{90}Y separation. If processing or counting capacity is limited, concentrate resources on ^{90}Sr WCS and counting first. The ^{90}Y WCS are not compromised by ingrowth but must only be counted promptly enough to minimize decay and optimize counting statistics.

- A1.3.8. Strip strontium from each column by adding 10 mL of 0.05-M HNO_3 to each column, catching the effluents containing ^{90}Sr in the centrifuge tube.
- A1.3.9. Quantitatively transfer ^{90}Sr and ^{90}Y fractions to respective tared planchets using three portions of 0.05-M HNO_3 .
- A1.3.10. Evaporate to dryness using the same techniques used for sample test sources.

Note: Gravimetric measurements may be performed following the counting to minimize elapsed time between separation and counting.

- A1.4. Weigh the ^{90}Sr and ^{90}Y WCS sources and calculate the net residue mass.
 - A1.4.1. The net mass of the strontium nitrate precipitate shall indicate near quantitative yield of strontium of 95–103%. If strontium yield falls outside this range, determine and address the cause for the losses and repeat the process. The known activity of ^{90}Sr in the standard is corrected for losses based on the measured chemical yields of the strontium carrier.

Note that no correction shall be applied for values greater than 100% because this will produce a negative bias in the calibrated efficiency.

- A1.4.2. The net residue mass of the ^{90}Y should be equivalent to that of the associated blank (i.e., ~0.0 mg). Higher residue mass may indicate the breakthrough of strontium and will result in high bias in the ^{90}Y efficiency. If blank corrected net residue mass exceeds 3% of the strontium carrier added, determine and address the cause for the elevated mass and repeat the process.
 - A1.4.3. Count three ^{90}Sr WCS on each detector to be calibrated, for sufficient time to accumulate at least 10,000 net counts.
 - A1.4.4. Count three ^{90}Y WCS on each detector to be calibrated, for sufficient time to accumulate at least 10,000 net counts.
 - A1.4.5. Count the associated blanks as a gross contamination check on the process. If indications of contamination are noted, take appropriate corrective actions to minimize spread and prevent cross-contamination of other samples in the laboratory.
- A1.5. Verify the calibration of each detector according to ASTM Standard Practice D7282, Section 16, and the laboratory quality manual and standard operating procedures.

A1.6. Calculations and data reduction for ⁹⁰Sr and ⁹⁰Y calibrations and calibration verifications are presented in Sections A2, A3, and A4. Calculations for total radiostrontium are in Section 12.

A2. Calculation of Detection Efficiency for ⁹⁰Sr

A2.1. Calculate the following decay and ingrowth factors for each WCS:

$$DF_s = e^{-\lambda_{Sr90}(t_1-t_0)} \quad (A1)$$

$$IF_{Y90} = 1 - e^{-\lambda_{Y90}(t_2-t_1)} \quad (A2)$$

where

- DF_s = decay factor for decay of the ⁹⁰Sr standard from its reference date until the ⁹⁰Sr/⁹⁰Y separation
- IF_{Y90} = ingrowth factor for ingrowth of ⁹⁰Y after the ⁹⁰Sr/⁹⁰Y separation
- λ_{Sr90} = decay constant for ⁹⁰Sr, $7.642 \times 10^{-10} \text{ s}^{-1}$
- λ_{Y90} = decay constant for ⁹⁰Y, $3.005 \times 10^{-6} \text{ s}^{-1}$
- t_0 = reference date and time for the ⁹⁰Sr standard
- t_1 = date and time of the Sr/Y separation
- t_2 = date and time of the midpoint of the ⁹⁰Sr count

Note: The elapsed time between the sample count and the reference date must be calculated using the same time units as the decay constant

A2.2. Calculate the ⁹⁰Sr detection efficiency for each WCS:

$$\epsilon_{Sr90,i} = \frac{R_{s,i} - R_b}{AC_{Sr90 \text{ std}} \times V_{s,i} \times DF_{s,i}} - IF_{Y90,i} \times \bar{\epsilon}_{Y90} = \frac{R_{n,i}}{AC_{Sr90 \text{ std}} \times V_{s,i} \times DF_{s,i}} - IF_{Y90,i} \times \bar{\epsilon}_{Y90} \quad (A3)$$

where

- $\epsilon_{Sr90,i}$ = ⁹⁰Sr detection efficiency for the i^{th} WCS
- $\bar{\epsilon}_{Y90}$ = average ⁹⁰Y detection efficiency (from Step A3.2)
- $R_{s,i}$ = beta gross count rate for the i^{th} WCS (in cpm)
- R_b = background count rate, in cpm
- $R_{n,i}$ = beta net count rate for the i^{th} WCS (cpm)
- $AC_{Sr90 \text{ std}}$ = activity concentration of the ⁹⁰Sr standard solution on its reference date (cpm/mL or cpm/g)
- $V_{s,i}$ = amount (volume or mass) of the standard solution added to the i^{th} WCS

A2.3. Average the efficiencies determined in Step A2.2 for all the WCSs to obtain the final detection efficiency for ⁹⁰Sr.

$$\epsilon_{Sr90} = \bar{\epsilon}_{Sr90} = \frac{1}{n} \sum_{i=1}^n \epsilon_{Sr90,i} \quad (A4)$$

where

- $\epsilon_{Sr90,i}$ = ⁹⁰Sr detection efficiency determined for the i^{th} WCS in A2.2,
- n = number of WCSs prepared and counted.

A2.4. Calculate the standard uncertainty of the average ⁹⁰Sr detection efficiency as follows:

$$u(\bar{\varepsilon}_{\text{Sr90}}) = \sqrt{\frac{1}{n^2} \sum_{i=1}^n \frac{u^2(R_{n,i}) + R_{n,i}^2 u_r^2(V_{s,i})}{AC_{\text{Sr90 std}}^2 V_{s,i}^2 DF_{s,i}^2} + (u^2(\bar{\varepsilon}_{\text{Y90}}) - \bar{\varepsilon}_{\text{Y90}}^2 u_r^2(AC_{\text{Sr90 std}})) \overline{IF}_{\text{Y90}}^2 + \bar{\varepsilon}_{\text{Sr90}}^2 u_r^2(AC_{\text{Sr90 std}})} \quad (\text{A5})$$

where

$$\overline{IF}_{\text{Y90}} = \frac{1}{n} \sum_{i=1}^n IF_{\text{Y90},i} = \text{average value of } ^{90}\text{Y ingrowth factors} \quad (\text{A6})$$

and

$$\begin{aligned} u(\cdot) &= \text{standard uncertainty of the value in parentheses,} \\ u_r(\cdot) &= \text{relative standard uncertainty of the value in parentheses.} \end{aligned}$$

A3. Detection Efficiency for ⁹⁰Y

A3.1. Calculate the ⁹⁰Y detection efficiency, $\varepsilon_{\text{Y90},i}$, for each WCS,

$$\varepsilon_{\text{Y90},i} = \frac{R_{s,i} - R_b}{AC_{\text{Sr90 std}} V_{s,i} DF_{s,i}} = \frac{R_{n,i}}{AC_{\text{Sr90 std}} V_{s,i} DF_{s,i}} \quad (\text{A7})$$

where

$$DF_{s,i} = e^{-\lambda_{\text{Sr90}}(t_1 - t_0)} e^{-\lambda_{\text{Y90}}(t_2 - t_1)} \quad (\text{A8})$$

and

$$\begin{aligned} \varepsilon_{\text{Y90},i} &= ^{90}\text{Y detection efficiency determined for the WCS} \\ R_{s,i} &= \text{beta gross count rate for the } i^{\text{th}} \text{ WCS (cpm)} \\ R_b &= \text{background count rate, in cpm} \\ R_{n,i} &= \text{beta net count rate for the } i^{\text{th}} \text{ WCS (cpm)} \\ AC_{\text{Sr90 std}} &= \text{activity concentration of the } ^{90}\text{Sr standard solution on its reference} \\ &\quad \text{date (dpm/mL or dpm/g)} \\ V_{s,i} &= \text{amount of the standard solution added to the } i^{\text{th}} \text{ WCS (mL or g)} \\ DF_{s,i} &= \text{combined correction factor for decay of the } ^{90}\text{Sr standard in the } i^{\text{th}} \\ &\quad \text{WCS from its reference date until } ^{90}\text{Y separation, and for the decay} \\ &\quad \text{of } ^{90}\text{Y from its separation until the midpoint of the count} \\ \lambda_{\text{Sr90}} &= \text{decay constant for } ^{90}\text{Sr, } 7.642 \times 10^{-10} \text{ s}^{-1} \\ \lambda_{\text{Y90}} &= \text{decay constant for } ^{90}\text{Y, } 3.005 \times 10^{-6} \text{ s}^{-1} \\ t_0 &= \text{reference date and time for the } ^{90}\text{Sr standard} \\ t_1 &= \text{date and time of the } ^{90}\text{Y separation} \\ t_2 &= \text{date and time at the midpoint of the } ^{90}\text{Y count} \end{aligned}$$

Note: The elapsed time between the sample count and the reference date must be calculated using the same time units as the decay constant

A3.2. Average the efficiencies determined in Step A3.1 to obtain the final detection efficiency for ⁹⁰Y.

$$\varepsilon_{\text{Y90}} = \bar{\varepsilon}_{\text{Y90}} = \frac{1}{n} \sum_{i=1}^n \varepsilon_{\text{Y90},i} \quad (\text{A9})$$

where

$$\begin{aligned} \varepsilon_{\text{Y90},i} &= ^{90}\text{Y detection efficiency determined for the } i^{\text{th}} \text{ WCS in Step A3.1} \\ n &= \text{number of WCS prepared and counted} \end{aligned}$$

A3.3. The combined standard uncertainty of the average efficiency for ⁹⁰Y including uncertainty associated with the preparation of the calibration standards is calculated as follows:

$$u(\bar{\epsilon}_{Y90}) = \sqrt{\frac{1}{n^2} \sum_{i=1}^n \frac{u^2(R_{n,i}) + R_{n,i}^2 u_r^2(V_{s,i})}{AC_{Sr90\text{ std}}^2 V_{s,i}^2 DF_{s,i}^2} + \bar{\epsilon}_{Y90}^2 u_r^2(AC_{Sr90\text{ std}})} \quad (\text{A10})$$

where

$u(\cdot)$ = standard uncertainty of the value in parentheses,
 $u_r(\cdot)$ = relative standard uncertainty of the value in parentheses.

A4. Calculate the covariance and correlation coefficient for the ⁹⁰Sr efficiency and the ⁹⁰Y efficiency:

$$u(\bar{\epsilon}_{Sr90}, \bar{\epsilon}_{Y90}) = \bar{\epsilon}_{Sr90} \bar{\epsilon}_{Y90} u_r^2(AC_{Sr90\text{ std}}) - (u^2(\bar{\epsilon}_{Y90}) - \bar{\epsilon}_{Y90}^2 u_r^2(AC_{Sr90\text{ std}})) \overline{IF}_{Y90} \quad (\text{A11})$$

and

$$r(\bar{\epsilon}_{Sr90}, \bar{\epsilon}_{Y90}) = \frac{u(\bar{\epsilon}_{Sr90}, \bar{\epsilon}_{Y90})}{u(\bar{\epsilon}_{Sr90}) u(\bar{\epsilon}_{Y90})} \quad (\text{A12})$$

where

$u(\cdot, \cdot)$ = estimated covariance of the two quantities in parentheses,
 $r(\cdot, \cdot)$ = estimated correlation coefficient of the two quantities in parentheses,
 $u(\cdot)$ = standard uncertainty of the quantity in parentheses,
 $u_r(\cdot)$ = relative standard uncertainty of the quantity in parentheses.

A5. Detection Efficiency for ⁸⁹Sr (*if needed for Appendix B Calculations*)

A5.1. Calculate the detection efficiency, $\epsilon_{Sr89,i}$, for each WCS as follows:

$$\epsilon_{Sr89,i} = \frac{R_{s,i} - R_b}{AC_{Sr89\text{ std}} V_{s,i} DF_{s,i}} = \frac{R_{n,i}}{AC_{Sr89\text{ std}} V_{s,i} DF_{s,i}} \quad (\text{A13})$$

where

$$DF_{s,i} = e^{-\lambda_{Sr89}(t_1 - t_0)} \quad (\text{A14})$$

and

$\epsilon_{Sr89,i}$ = ⁸⁹Sr detection efficiency for the i^{th} WCS
 $R_{s,i}$ = beta gross count rate for the i^{th} WCS (cpm)
 R_b = background count rate, in cpm
 $AC_{Sr89\text{ std}}$ = activity concentration of the ⁸⁹Sr standard solution on the reference date (dpm/mL or dpm/g)
 $V_{s,i}$ = amount (volume or mass) of the standard solution added to the i^{th} WCS (mL or g)
 $DF_{s,i}$ = correction factor for decay of the ⁸⁹Sr standard for the i^{th} WCS from its reference date until the midpoint of the sample count
 λ_{Sr89} = decay constant for ⁸⁹Sr, $1.372 \times 10^{-2} \text{ d}^{-1}$
 t_0 = reference date and time for the ⁸⁹Sr standard
 t_1 = date and time at the midpoint of the ⁸⁹Sr count

A5.1.1. Average the efficiencies determined in Step A5.1 to obtain the final detection efficiency for ⁸⁹Sr.

$$\varepsilon_{\text{Sr89}} = \bar{\varepsilon}_{\text{Sr89}} = \frac{1}{n} \sum_{i=1}^n \varepsilon_{\text{Sr89},i} \quad (\text{A15})$$

where

$\varepsilon_{\text{Sr89},i}$ = ⁸⁹Sr detection efficiency determined for the *i*th WCS in Step A5.1,
 n = number of WCSs prepared and counted.

A5.1.2. The combined standard uncertainty of the average efficiency for ⁸⁹Sr including uncertainty associated with the preparation of the calibration standards is calculated as follows:

$$u(\bar{\varepsilon}_{\text{Sr89}}) = \sqrt{\frac{1}{n^2} \sum_{i=1}^n \frac{u^2(R_{n,i}) + R_{n,i}^2 u_r^2(V_{s,i})}{AC_{\text{Sr89 std}}^2 V_{s,i}^2 DF_{s,i}^2} + \bar{\varepsilon}_{\text{Sr89}}^2 u_r^2(AC_{\text{Sr89 std}})} \quad (\text{A16})$$

where

$u(\cdot)$ = standard uncertainty of the value in parentheses,
 $u_r(\cdot)$ = relative standard uncertainty of the value in parentheses.

Appendix B: Calculations for Isotopic ⁸⁹Sr and ⁹⁰Sr Results

A numerical approach for determining ⁸⁹Sr and ⁹⁰Sr activity from a single sample is performed by a number of laboratories. This presentation, however, allows a more rigorous evaluation of uncertainties than commonly employed. Lacking this treatment, many labs have found that the traditional approach (evaluating counting uncertainty for a single count only) has led to overestimation of the quality of results, and to poor decisions regarding the presence or absence of low activities of one radioisotope of strontium in the presence of elevated activities of the second.

These calculations may be valuable to laboratories who wish to determine isotopic ⁸⁹Sr and ⁹⁰Sr in a large number of samples with a minimum of additional effort beyond the initial preparation and counting of total radiostrontium. Specifically, it involves performing a second count of the same radiostrontium sample test source (STS) and mathematically resolving the activity of the two isotopes. Although the STS may be recounted as soon as 1–2 days after the initial count, resolution is optimized if the two counts span as large a range of the ⁹⁰Y ingrowth as practicable. The time elapsed between the chemical separation and the first count should be minimized, while the second count should optimally proceed as ⁹⁰Y approaches secular equilibrium with ⁹⁰Sr but before significant decay of ⁸⁹Sr has occurred, for example, after 3–5 half-lives of ⁹⁰Y have elapsed (1–2 weeks).

This section may not be employed without complete validation of the approach by the laboratory, including testing with samples containing ratios of ⁹⁰Sr relative to ⁸⁹Sr varying from pure ⁹⁰Sr to pure ⁸⁹Sr.

B1. The equations in this section are used to calculate the ⁹⁰Sr and ⁸⁹Sr activity of a sample from data generated from two successive counts of the same radiostrontium sample test source.

B1.1. For each of the two counting measurements ($i = 1, 2$), calculate the following decay and ingrowth factors:

$$DF_{Sr89,i} = e^{\lambda_{Sr89}(t_i - t_0)} \quad (B1)$$

$$DF_{Sr90,i} = e^{-\lambda_{Sr90}(t_i - t_0)} \quad (B2)$$

$$F_{Y90,i} = e^{-\lambda_{Sr90}(t_{sep} - t_0)} \left(1 - e^{-\lambda_{Y90}(t_i - t_{sep})} \right) \quad (B3)$$

where:

$DF_{Sr89,i}$ = decay factor for decay of ⁸⁹Sr from the collection date to the midpoint of the i^{th} count of the STS

$DF_{Sr90,i}$ = decay factor for decay of ⁹⁰Sr from the collection date to the midpoint of the i^{th} count of the STS

$F_{Sr90,i}$ = combined decay and ingrowth factor for decay of ⁹⁰Sr from the collection date to the Sr/Y separation and ingrowth of ⁹⁰Y from the separation to the midpoint of the i^{th} count of the STS

λ_{Sr89} = decay constant for ⁸⁹Sr = $1.587 \times 10^{-7} \text{ s}^{-1}$

λ_{Sr90} = decay constant for ⁹⁰Sr = $7.642 \times 10^{-10} \text{ s}^{-1}$

t_0	=	collection date and time for the sample
t_{sep}	=	date and time of the Sr/Y separation
t_i	=	date and time of the midpoint of the i^{th} count of the STS

Note: The elapsed time between the sample count and the reference date must be calculated using the same time units as the decay constant

B1.2. For $i = 1, 2$, use the results from Section A5.1 in Appendix A to calculate the following sensitivity factors:

$$a_i = DF_{\text{Sr}89,i} \varepsilon_{\text{Sr}89,i} \quad (\text{B4})$$

$$b_i = DF_{\text{Sr}90,i} \varepsilon_{\text{Sr}90,i} + F_{\text{Y}90,i} \varepsilon_{\text{Y}90,i} \quad (\text{B5})$$

where

a_i	=	sensitivity of the count rate in the i^{th} measurement to ⁸⁹ Sr activity,
b_i	=	sensitivity of the count rate in the i^{th} measurement to ⁹⁰ Sr activity.
$\varepsilon_{\text{Y}90,i}$	=	⁹⁰ Y efficiency of the detector for the i^{th} count of the STS,
$\varepsilon_{\text{Sr}90,i}$	=	⁹⁰ Sr efficiency of the detector for the i^{th} count of the STS.

B1.3. Calculate the standard uncertainties of the sensitivity factors using the equations:

$$u(a_i) = DF_{\text{Sr}89,i} u(\varepsilon_{\text{Sr}89,i}) \quad (\text{B6})$$

$$u(b_i) = \sqrt{DF_{\text{Sr}90,i}^2 u^2(\varepsilon_{\text{Sr}90,i}) + F_{\text{Y}90,i}^2 u^2(\varepsilon_{\text{Y}90,i}) + 2DF_{\text{Sr}90,i} F_{\text{Y}90,i} u(\varepsilon_{\text{Sr}90,i}, \varepsilon_{\text{Y}90,i})} \quad (\text{B7})$$

where the estimated covariance of the ⁹⁰Sr and ⁹⁰Y efficiencies is calculated as follows:

$$u(\varepsilon_{\text{Sr}90,i}, \varepsilon_{\text{Y}90,i}) = r(\varepsilon_{\text{Sr}90,i}, \varepsilon_{\text{Y}90,i}) u(\varepsilon_{\text{Sr}90,i}) u(\varepsilon_{\text{Y}90,i}) \quad (\text{B8})$$

and where the estimated correlation coefficient $r(\varepsilon_{\text{Sr}90,i}, \varepsilon_{\text{Y}90,i})$ was determined during the calibration.

B1.4. Calculate the covariances $u(a_1, a_2)$ and $u(b_1, b_2)$ as follows:

$$u(a_1, a_2) = \begin{cases} u(a_1)u(a_2), & \text{if only one detector is used} \\ a_1 a_2 u_r^2(AC_{\text{Sr}89 \text{ std}}), & \text{if two detectors are used} \end{cases} \quad (\text{B9})$$

$$u(b_1, b_2) = \begin{cases} (DF_{Sr90,1}F_{Y90,2} + DF_{Sr90,2}F_{Y90,1})u(\varepsilon_{Sr90,1}, \varepsilon_{Y90,1}) \\ + DF_{Sr90,1}DF_{Sr90,2}u^2(\varepsilon_{Sr90,1}) + F_{Y90,1}F_{Y90,2}u^2(\varepsilon_{Y90,1}), & \text{using only one detector} \quad (B10) \\ b_1b_2u_r^2(AC_{Sr90std}), & \text{using two detectors} \end{cases}$$

where

$AC_{Sr89std}$ = activity concentration of the ⁸⁹Sr standard used for calibration
 $AC_{Sr90std}$ = activity concentration of the ⁹⁰Sr standard used for calibration
 $u_r(\cdot)$ = relative standard uncertainty of the quantity in parentheses

B1.5. For $i = 1, 2$, calculate the net beta count rates, $R_{n,i}$, and their standard uncertainties:

$$R_{n,i} = R_{a,i} - R_{b,i} \quad (B11)$$

$$u(R_{n,i}) = \sqrt{\frac{R_{a,i}}{t_{a,i}} + \frac{R_{b,i}}{t_{b,i}}} \quad (B12)$$

where:

$R_{n,i}$ = net beta count rate for the i^{th} count of the STS (cpm)
 $R_{a,i}$ = beta gross count rate for the i^{th} count of the STS (cpm)
 $R_{b,i}$ = beta background count rate for the i^{th} count of the STS (cpm)
 $t_{a,i}$ = sample count time for the i^{th} count of the STS (min)
 $t_{b,i}$ = background count time for the i^{th} count of the STS (min)

B1.6. Using the values calculated in A5.1 – A5.5, calculate the ⁸⁹Sr and ⁹⁰Sr activity concentrations:

$$AC_{Sr89} = \frac{b_2R_{n,1} - b_1R_{n,2}}{2.22 \times X \times V \times Y} \quad (B13)$$

$$AC_{Sr90} = \frac{a_1R_{n,2} - a_2R_{n,1}}{2.22 \times X \times V \times Y} \quad (B14)$$

where:

$$X = a_1b_2 - a_2b_1 \quad (B15)$$

and where:

2.22 = conversion factor from dpm to pCi
 Y = chemical yield for strontium
 V = sample volume (L)

B2. The standard counting uncertainties for ⁸⁹Sr ($u_{cc}(AC_{Sr89})$) and ⁹⁰Sr ($u_{cc}(AC_{Sr90})$) are calculated in units of pCi/L as follows:

$$u_{cc}(AC_{Sr89}) = \frac{\sqrt{b_2^2u^2(R_{n,1}) + b_1^2u^2(R_{n,2})}}{2.22 \times X \times V \times Y} \quad (B16)$$

$$u_{cC}(AC_{Sr90}) = \frac{\sqrt{a_1^2 u^2(R_{n,2}) + a_2^2 u^2(R_{n,1})}}{2.22 \times X \times V \times Y} \quad (\text{B17})$$

B3. The combined standard uncertainties (CSU) for ⁸⁹Sr and ⁹⁰Sr are calculated as follows:

$$u_c(AC_{Sr89}) = \left[u_{cC}^2(AC_{Sr89}) + AC_{Sr89}^2 \left(\frac{u^2(V)}{V^2} + \frac{u^2(Y)}{Y^2} + \frac{b_2^2 u^2(a_1) + b_1^2 u^2(a_2) - 2b_1 b_2 u(a_1, a_2)}{X^2} \right) + AC_{Sr90}^2 \frac{b_2^2 u^2(b_1) + b_1^2 u^2(b_2) - 2b_1 b_2 u(b_1, b_2)}{X^2} \right]^{1/2} \quad (\text{B18})$$

$$u_c(AC_{Sr90}) = \left[u_{cC}^2(AC_{Sr90}) + AC_{Sr90}^2 \left(\frac{u^2(V)}{V^2} + \frac{u^2(Y)}{Y^2} + \frac{a_2^2 u^2(b_1) + a_1^2 u^2(b_2) - 2a_1 a_2 u(b_1, b_2)}{X^2} \right) + AC_{Sr89}^2 \frac{a_2^2 u^2(a_1) + a_1^2 u^2(a_2) - 2a_1 a_2 u(a_1, a_2)}{X^2} \right]^{1/2} \quad (\text{B19})$$

**Appendix C:
Composition of Atlanta Drinking Water Used for this Study**

Metals by ICP-AES	Concentration (mg/L)*
Silicon	3.18
Aluminum	<0.200
Barium	0.0133
Calcium	9.38
Iron	<0.100
Magnesium	<0.500
Potassium	<0.500
Sodium	<0.500
Inorganic Anions	
Chloride	12.7
Sulfate	15.6
Nitrogen, Nitrate (as N)	1.19
Carbon Dioxide	
Bicarbonate Alkalinity	23.8
Carbonate Alkalinity	<3.00
Radionuclide	Concentration (pCi/L)**
Uranium 234, 235, 238	<0.01, <0.01, <0.01
Plutonium 238, 239/240	<0.02, <0.02
Americium 241	<0.02
Strontium 90	<0.3
Radium 226***	0.11 ± 0.27 -0.30 ± 0.45

Note: Analyses conducted by independent laboratories.

* Values below the reporting level are presented as less than (<) values.

No measurement uncertainty was reported with values greater than the "Reporting Level."

** Reported values represent the calculated minimum detectable concentration (MDC) for the radionuclide(s).

*** Two samples analyzed. Expanded uncertainty (k=2) as reported by the laboratory.

www.epa.gov
February 2010
Revision 0

Rapid Radiochemical Method for Isotopic Uranium in Water for Environmental Restoration Following Homeland Security Events

U.S. Environmental Protection Agency

**Office of Air and Radiation
Office of Radiation and Indoor Air
National Air and Radiation Environmental Laboratory
Montgomery, AL 36115**

**Office of Research and Development
National Homeland Security Research Center
Cincinnati, OH 45268**

ISOTOPIC URANIUM IN WATER: RAPID METHOD FOR HIGH-ACTIVITY SAMPLES

1. Scope and Application

- 1.1. The method will be applicable to samples where the source of the contamination is either known or unknown sample sources. If any filtration of the sample is performed prior to starting the analysis, those solids should be analyzed separately. The results from the analysis of these solids should be reported separately (as a suspended activity concentration for the water volume filtered), but identified with the filtrate results.
- 1.2. The method is specific for ^{238}U , ^{235}U , and ^{234}U in drinking water and other aqueous samples.
- 1.3. This method uses rapid radiochemical separations techniques for determining alpha-emitting uranium isotopes in water samples following a nuclear or radiological incident. Although the method can detect concentrations of ^{238}U , ^{235}U , and ^{234}U on the same order of magnitude as methods used for the Safe Drinking Water Act (SDWA), this method is not a substitute for SDWA-approved methods for isotopic uranium.
- 1.4. The method is capable of satisfying a required method uncertainty for ^{238}U , ^{235}U , or ^{234}U of 2.6 pCi/L at an analytical action level of 20 pCi/L. To attain the stated measurement quality objectives (MQOs) (see Section 9.3 and 9.4), a sample volume of approximately 200 mL and count time of at least 1 hour are recommended. The sample turnaround time and throughput may vary based on additional project MQOs, the time for analysis of the final counting form, and initial sample volume. The method must be validated prior to use following the protocols provided in *Method Validation Guide for Qualifying Methods Used by Radiological Laboratories Participating in Incident Response Activities* (EPA 2009, reference 16.5).
- 1.5. The method is intended to be used for water samples that are similar in composition to drinking water. The rapid uranium method was evaluated following the guidance presented for “Level E Method Validation: Adapted or Newly Developed Methods, Including Rapid Methods” in *Method Validation Guide for Qualifying Methods Used by Radiological Laboratories Participating in Incident Response Activities* (EPA 2009, reference 16.5) and Chapter 6 of *Multi-Agency Radiological Laboratory Analytical Protocols Manual* (MARLAP 2004, reference 16.6). The matrix used for the determination of uranium was drinking water from Atlanta, GA. See the Appendix for a listing of the chemical constituents of the water.
- 1.6. Multi-radionuclide analysis using sequential separation may be possible using this method in conjunction with other rapid methods.
- 1.7. This method is applicable to the determination of soluble uranium. This method is not applicable to the determination of uranium isotopes contained in highly insoluble particulate matter possibly present in water samples contaminated as a result of a radiological dispersion device (RDD) event.

2. Summary of Method

- 2.1. This method is based on the sequential elution of interfering radionuclides as well as other components of the matrix by extraction chromatography to isolate and purify uranium in order to prepare the uranium for counting by alpha spectrometry. The method utilizes vacuum assisted flow to improve the speed of the separations. Prior to

the use of the extraction resins, a water sample is filtered as necessary to remove any insoluble fractions, equilibrated with ^{232}U tracer, and concentrated by either evaporation or calcium phosphate precipitation. The sample test source (STS) is prepared by microprecipitation with NdF_3 . Standard laboratory protocol for the use of an alpha spectrometer should be used when the sample is ready for counting.

3. Definitions, Abbreviations and Acronyms

- 3.1. Analytical Protocol Specification (APS). The output of a directed planning process that contains the project's analytical data needs and requirements in an organized, concise form.
- 3.2. Analytical Action Level (AAL). The term "analytical action level" is used to denote the value of a quantity that will cause the decisionmaker to choose one of the alternative actions.
- 3.3. Analytical Decision Level (ADL). The analytical decision level refers to the value that is less than the AAL based on the acceptable error rate and the required method uncertainty.
- 3.4. Discrete Radioactive Particles (DRPs or "hot particles"). Particulate matter in a sample of any matrix where a high concentration of radioactive material is contained in a tiny particle (μm range).
- 3.5. *Multi-Agency Radiological Analytical Laboratory Protocol Manual* (MARLAP) (see Reference 16.6.)
- 3.6. Measurement Quality Objective (MQO). MQOs are the analytical data requirements of the data quality objectives and are project- or program-specific and can be quantitative or qualitative. These analytical data requirements serve as measurement performance criteria or objectives of the analytical process.
- 3.7. Radiological Dispersal Device (RDD), i.e., a "dirty bomb." This is an unconventional weapon constructed to distribute radioactive material(s) into the environment either by incorporating them into a conventional bomb or by using sprays, canisters, or manual dispersal.
- 3.8. Required Method Uncertainty (u_{MR}). The required method uncertainty is a target value for the individual measurement uncertainties, and is an estimate of uncertainty (of measurement) before the sample is actually measured. The required method uncertainty is applicable below an Analytical Action level.
- 3.9. Relative Required Method Uncertainty (ϕ_{MR}). The relative required method uncertainty is the u_{MR} divided by the AAL and typically expressed as a percentage. It is applicable above the AAL.
- 3.10. Sample Test Source (STS). This is the final form of the sample that is used for nuclear counting. This form is usually specific for the nuclear counting technique used in the method such as a solid deposited on a filter for alpha spectrometry analysis.

4. Interferences

4.1. Radiological

- 4.1.1. Spectral Overlap: Alpha-emitting radionuclides (or their short-lived decay progeny) with peaks at energies that cannot be adequately resolved from the tracer or analyte (e.g., for ^{232}U (5320, 5263 keV), ^{210}Po (5304 keV), ^{228}Th (5423, 5340 keV), and ^{243}Am (5275, 5233 keV)) must be chemically separated

to enable radionuclide-specific measurements. This method separates these radionuclides effectively. The significance of peak overlap will be determined by the individual detector's alpha energy resolution characteristics and the quality of the final precipitate that is counted.

- 4.2. Non-Radiological: Very high levels of competing higher valence anions (greater than divalent such as phosphates) will lead to lower yields when using the evaporation option due to competition with active sites on the resin. If higher valence anions are present, the phosphate precipitation option may need to be used initially in place of evaporation. If calcium phosphate coprecipitation is performed to collect uranium (and other potentially present actinides) from large-volume samples, the amount of phosphate added to coprecipitate the actinides (in Step 11.1.4.3) should be reduced to accommodate the sample's high phosphate concentration.

5. Safety

5.1. General

- 5.1.1. Refer to your safety manual for concerns of contamination control, personal exposure monitoring and radiation dose monitoring.
- 5.1.2. Refer to the laboratory chemical hygiene plan (or equivalent) for general safety rules regarding chemicals in the workplace.

5.2. Radiological

5.2.1. Hot particles (DRPs)

- 5.2.1.1. Hot particles, also termed "discrete radioactive particles" (DRPs), will be small, on the order of 1 mm or less. Typically, DRPs are not evenly distributed in the media and their radiation emissions are not uniform in all directions (anisotropic). Filtration using a 0.45- μm or finer filter will minimize the presence of these particles.
- 5.2.1.2. Care should be taken to provide suitable containment for filter media used in the pretreatment of samples that may have DRPs, because the particles become highly statically charged as they dry out and will "jump" to other surfaces causing contamination.
- 5.2.1.3. Filter media should be individually surveyed for the presence of these particles, and this information reported with the final sample results.

- 5.2.2. For samples with detectable activity concentrations of these radionuclides, labware should be used only once due to potential for cross contamination.

5.3. Procedure-Specific Non-Radiological Hazards:

- 5.3.1. Particular attention should be paid to the discussion of hydrofluoric acid (HF). HF is an extremely dangerous chemical used in the preparation of some of the reagents and in the microprecipitation procedure. Appropriate personal protective equipment (PPE) must be obtained and used in strict accordance with the laboratory safety program specification.

6. Equipment and Supplies

- 6.1. Analytical balance with 0.01-g readability or better.
- 6.2. Cartridge reservoirs, 10- or 20-mL syringe style with locking device, or equivalent.
- 6.3. Centrifuge able to accommodate 250-mL flasks.

- 6.4. Centrifuge flasks with 250-mL capacity.
- 6.5. Filter with 0.45- μm membrane.
- 6.6. Filter apparatus with a 25-mm diameter, polysulfone, filtration chimney, stem support, and stainless steel support. A single-use (disposable) filter funnel/filter combination may be used, to avoid cross contamination.
- 6.7. 25-mm polypropylene filter with 0.1- μm pore size.
- 6.8. Stainless steel planchets or other sample mounts that are able to hold the 25-mm filter.
- 6.9. Tweezers.
- 6.10. 100- μL pipette, or equivalent, and appropriate plastic tips.
- 6.11. 10-mL plastic culture tubes with caps.
- 6.12. Vacuum pump or laboratory vacuum system.
- 6.13. Tips, white inner, Eichrom part number AC-1000-IT, or equivalent.
- 6.14. Tips, yellow outer, Eichrom part number AC-1000-OT, or equivalent.
- 6.15. Vacuum Box, such as Eichrom part number AC-24-BOX, or equivalent.
- 6.16. Vortex mixer.
- 6.17. Miscellaneous labware, plastic or glass, both 250 and 350 mL.

7. Reagents and Standards

Note: All reagents are American Chemical Society (ACS) reagent grade or equivalent unless otherwise specified.

Note: Unless otherwise indicated, all references to water should be understood to mean Type I Reagent water. All solutions used in microprecipitation should be prepared with water filtered through a 0.45- μm (or better) filter.

- 7.1. Ammonium hydrogen oxalate (0.1M): Dissolve 6.3 g of oxalic acid ($\text{H}_2\text{C}_2\text{O}_4 \cdot 2\text{H}_2\text{O}$) and 7.1 g of ammonium oxalate ($(\text{NH}_4)_2\text{C}_2\text{O}_4 \cdot \text{H}_2\text{O}$) in 900 mL of water, and dilute to 1 L with water.
- 7.2. Ammonium hydrogen phosphate (3.2 M): Dissolve 106 g of $(\text{NH}_4)_2\text{HPO}_4$ in 200 mL of water. Heat gently to dissolve and dilute to 250 mL with water.
- 7.3. Ammonium hydroxide (15 M): Concentrated NH_4OH , available commercially.
- 7.4. Ammonium thiocyanate indicator (1 M): Dissolve 7.6 g of ammonium thiocyanate (NH_4SCN) in 90 mL of water and dilute to 100 mL with water. An appropriate quantity of sodium thiocyanate (8.1 g) or potassium thiocyanate (9.7 g) may be substituted for ammonium thiocyanate.
- 7.5. Ascorbic acid (1 M): Dissolve 17.6 g of ascorbic acid ($\text{C}_6\text{H}_8\text{O}_6$) in 90 mL of water and dilute to 100 mL with water. Prepare weekly.
- 7.6. Calcium nitrate (0.9 M): Dissolve 53 g of calcium nitrate tetrahydrate ($\text{Ca}(\text{NO}_3)_2 \cdot 4\text{H}_2\text{O}$) in 100 mL of water and dilute to 250 mL with water.
- 7.7. Ethanol, 100 %: Anhydrous $\text{C}_2\text{H}_5\text{OH}$, available commercially.
 - 7.7.1. Ethanol, (~80% v/v): Mix 80 mL 100% ethanol and 20 mL water.
- 7.8. Ferrous sulfamate (0.6 M): Add 57 g of sulfamic acid ($\text{NH}_2\text{SO}_3\text{H}$) to 150 mL of water and heat to 70 °C. Slowly add 7 g of iron powder (< 100 mesh size) while heating and stirring (magnetic stirrer should be used) until dissolved (may take as long as two hours). Filter the hot solution (using a qualitative filter), transfer to flask, and dilute to 200 mL with water. Prepare fresh weekly.
- 7.9. Hydrochloric acid (12 M): Concentrated HCl , available commercially.

- 7.9.1. Hydrochloric acid (9 M): Add 750 mL of concentrated HCl to 100 mL of water and dilute to 1 L with water.
 - 7.9.2. Hydrochloric acid (4 M): Add 333 mL of concentrated HCl to 500 mL of water and dilute to 1 L with water.
 - 7.9.3. Hydrochloric acid (1 M): Add 83 mL of concentrated HCl to 500 mL of water and dilute to 1 L with water.
 - 7.10. Hydrofluoric acid (28 M): Concentrated HF, available commercially.
 - 7.10.1. Hydrofluoric acid (0.58 M): Add 20 mL of concentrated HF to 980 mL of filtered demineralized water and mix. Store in a plastic bottle.
 - 7.11. Neodymium standard solution (1000 $\mu\text{g}/\text{mL}$): May be purchased from a supplier of standards for atomic spectroscopy.
 - 7.12. Neodymium carrier solution (0.50 mg/mL): Dilute 10 mL of the neodymium standard solution (7.11) to 20.0 mL with filtered demineralized water. This solution is stable for up to six months.
 - 7.13. Neodymium fluoride substrate solution (10 $\mu\text{g}/\text{mL}$): Pipette 5.0 mL of neodymium standard solution (7.11) into a 500-mL plastic bottle. Add 460 mL of 1-M HCl to the plastic bottle. Cap the bottle and shake to mix. Measure 40 mL of concentrated HF in a plastic graduated cylinder and add to the bottle. Recap the bottle and shake to mix thoroughly. This solution is stable for up to six months.
 - 7.14. Nitric acid (16M): Concentrated HNO_3 , available commercially.
 - 7.14.1. Nitric acid (3 M): Add 191 mL of concentrated HNO_3 to 700 mL of water and dilute to 1 L with water.
 - 7.14.2. Nitric acid (2 M): Add 127 mL of concentrated HNO_3 to 800 mL of water and dilute to 1 L with water.
 - 7.14.3. Nitric acid (0.5 M): Add 32 mL of concentrated HNO_3 to 900 mL of water and dilute to 1 L with water.
 - 7.15. Nitric acid (3 M) – aluminum nitrate (1.0 M) solution: Dissolve 210 g of anhydrous aluminum nitrate ($\text{Al}(\text{NO}_3)_3$) in 700 mL of water. Add 190 mL of concentrated HNO_3 (7.14) and dilute to 1 L with water. An appropriate quantity of aluminum nitrate nonahydrate (375 g) may be substituted for anhydrous aluminum nitrate.
 - 7.16. Phenolphthalein solution: Dissolve 1 g phenolphthalein in 100 mL 95% isopropyl alcohol and dilute with 100 mL of water.
 - 7.17. Titanium chloride: 20 % solution, stored in an air-tight container and away from light.
 - 7.18. Uranium-232 tracer solution: 6–10 dpm of ^{232}U per aliquant, activity added known to at least 5 % (combined standard uncertainty of no more than 5 %).
 - 7.19. UTEVA Resin: 2-mL cartridge, 50–100 μg , Eichrom part number UT-R50-S and UT-R200-S, or equivalent.
8. Sample Collection, Preservation, and Storage
- 8.1. No sample preservation is required if sample is delivered to the laboratory within 3 days of sampling date/time.
 - 8.2. If the dissolved concentration of uranium is sought, the insoluble fraction must be removed by filtration before preserving with acid.
 - 8.3. If the sample is to be held for more than three days, nitric acid shall be added until $\text{pH} < 2$.

9. Quality Control

- 9.1. Batch quality control results shall be evaluated and meet applicable Analytical Project Specifications (APS) prior to release of unqualified data. In the absence of project-defined APS or a project-specific quality assurance project plan (QAPP), the quality control sample acceptance criteria defined in the laboratory quality manual and procedures shall be used to determine acceptable performance for this method.
 - 9.1.1. A laboratory control sample (LCS) shall be run with each batch of samples. The concentration of the LCS should be at or near the action level or level of interest for the project.
 - 9.1.2. One method blank shall be run with each batch of samples. The laboratory blank should consist of laboratory water.
 - 9.1.3. One laboratory duplicate shall be run with each batch of samples. The laboratory duplicate is prepared by removing an aliquant from the original sample container.
 - 9.1.4. A matrix spike sample may be included as a batch quality control sample if there is concern that matrix interferences, may compromise chemical yield measurements, or overall data quality.
- 9.2. The source preparation method should produce a sample test source that produces a spectrum with the full width at half maximum (FWHM) of 50–100 keV for each peak in the spectrum (with the exception of ^{235}U). Precipitate reprocessing should be considered if this range of FWHM cannot be achieved.
- 9.3. This method is capable of achieving a u_{MR} of 2.6 pCi/L at or below an action level of 20 pCi/L. This may be adjusted if the event-specific MQOs are different.
- 9.4. This method is capable of achieving a ϕ_{MR} of 13 % above 20 pCi/L. This may be adjusted if the event-specific MQOs are different.
- 9.5. This method is capable of achieving a required minimum detectable concentration (MDC) of 1.5 pCi/L.

10. Calibration and Standardization

- 10.1. Set up the alpha spectrometry system according to the manufacturer's recommendations. The energy range of the spectrometry system should at least include the region between 3–8 MeV.
- 10.2. Calibrate each detector used to count samples according to ASTM Standard Practice D7282, Section 18, "Alpha Spectrometry Instrument Calibrations" (see reference 16.3).
- 10.3. Continuing Instrument Quality Control Testing shall be performed according to ASTM Standard Practice D7282, Sections 20, 21, and 24.

11. Procedure

11.1. Water Sample Preparation

- 11.1.1. As required, filter the 100-200 mL sample aliquant through a 0.45- μm filter and collect the sample in an appropriate size beaker.
- 11.1.2. Acidify the sample with concentrated HNO_3 . This usually requires adding about 2 mL of concentrated HNO_3 per 1000 mL of sample. However, samples that are initially alkaline, or that may have high carbonate content, may require substantially more acid. It is important that the pH be verified to be below 2.0, ensuring that all carbonate (a uranium complexing agent) has been removed.

11.1.3. Following the laboratory protocol, add 6–10 dpm of ^{232}U as a tracer.

Note: For a sample approximately 100 mL or less, the evaporation option is recommended. Proceed to Step 11.1.5. Otherwise continue to Step 11.1.4.

11.1.4. Calcium phosphate coprecipitation option

11.1.4.1. Add 0.5 mL of 0.9 M $\text{Ca}(\text{NO}_3)_2$ to each beaker. Place each beaker on a hot plate, cover with a watch glass, and heat until boiling.

11.1.4.2. Once the sample boils, take the watch glass off the beaker and lower the heat.

11.1.4.3. Add 2-3 drops of phenolphthalein indicator and 200 μL of 3.2 M $(\text{NH}_4)_2\text{HPO}_4$ solution.

11.1.4.4. Add enough concentrated NH_4OH with a squeeze bottle to reach the phenolphthalein end point (a persistent pink color) and form $\text{Ca}_3(\text{PO}_4)_2$ precipitate. NH_4OH should be added very slowly. Stir the solution with a glass rod. Allow the sample to heat gently to digest the precipitate for another 20–30 minutes.

Note: The calcium phosphate precipitation should be completed promptly following pH adjustment to the phenolphthalein endpoint to minimize absorption of CO_2 and formation of a soluble carbonate complex with U that will lead to incomplete precipitation of U.

11.1.4.5. If the sample volume is too large to centrifuge the entire sample, allow precipitate to settle until solution can be decanted (30 minutes to 2 hours) and go to Step 11.1.4.7.

11.1.4.6. If the volume is small enough to centrifuge go to Step 11.1.4.8.

11.1.4.7. Decant supernatant solution and discard to waste.

11.1.4.8. Transfer the precipitate to a 250-mL centrifuge tube, completing the transfer with a few milliliters of water, and centrifuge the precipitate for approximately 10 minutes at 2000 rpm.

11.1.4.9. Decant supernatant solution and discard to waste.

11.1.4.10. Wash the precipitate with an amount of water approximately twice the volume of the precipitate. Mix well using a stirring rod, breaking up the precipitate if necessary. Centrifuge for 5–10 minutes at 2000 rpm. Discard the supernatant solution.

11.1.4.11. Dissolve precipitate in approximately 5 mL concentrated HNO_3 . Transfer solution to a 100 mL beaker. Rinse centrifuge tube with 2–3 mL of concentrated HNO_3 and transfer to the same beaker. Evaporate solution to dryness and go to Step 11.2.

11.1.5. Evaporation option to reduce volume and to digest organic components

11.1.5.1. Evaporate sample to less than 50 mL and transfer to a 100 mL beaker.

Note: For some water samples, CaSO_4 formation may occur during evaporation. If this occurs, use the calcium phosphate precipitation option in Step 11.1.4.

- 11.1.5.2. Gently evaporate the sample to dryness and redissolve in approximately 5 mL of concentrated HNO_3 .
- 11.1.5.3. Repeat Step 11.1.5.2 two more times, evaporate to dryness, and go to Step 11.2.

11.2. Actinide Separations using Eichrom Resins

11.2.1. Redissolve $\text{Ca}_3(\text{PO}_4)_2$ residue or evaporated water sample

- 11.2.1.1. Dissolve either residue with 10 mL of 3 M HNO_3 – 1.0 M $\text{Al}(\text{NO}_3)_3$.

Note: An additional 5 mL may be necessary if the residue volume is large.

- 11.2.1.2. Add 2 mL of 0.6 M ferrous sulfamate to each solution. Swirl to mix.

Note: If the additional 5 mL was used to dissolve the sample in Step 11.2.1.1, add a total of 3 mL of ferrous sulfamate solution.

- 11.2.1.3. Add 1 drop of 1 M ammonium thiocyanate indicator to each sample and mix.

Note: The color of the solution turns deep red, due to the formation of soluble ferric thiocyanate complex.

- 11.2.1.4. Add 1 mL of 1 M ascorbic acid to each solution, swirling to mix. Wait for 2-3 minutes.

Note: The red color should disappear which indicates reduction of Fe^{+3} to Fe^{+2} . If the red color persists, then additional ascorbic acid solution is added drop-wise with mixing until the red color disappears.

Note: If particles are observed suspended in the solution, centrifuge the sample at 2000 rpm. The supernatant solution will be transferred to the column in Step 11.2.3.1. The precipitates will be discarded.

- 11.2.2. Set up the vacuum box with UTEVA cartridges as follows:

Note: Steps 11.2.2.1 to 11.2.2.5 deal with a commercially available filtration system. Other vacuum systems developed by individual laboratories may be substituted here as long as the laboratory has provided guidance to analysts in their use.

- 11.2.2.1. Place the inner tube rack (supplied with vacuum box) into the vacuum box with the centrifuge tubes in the rack. Fit the lid to the vacuum system box.
- 11.2.2.2. Place the yellow outer tips into all 24 openings of the lid of the vacuum box. Fit in the inner white tip into each yellow tip.
- 11.2.2.3. For each sample solution, fit in the UTEVA cartridge on to the inner white tip.
- 11.2.2.4. Lock syringe barrels (funnels/reservoirs) to the top end of the UTEVA cartridge.

- 11.2.2.5. Connect the vacuum pump to the box. Turn the vacuum pump on and ensure proper fitting of the lid.

IMPORTANT: The unused openings on the vacuum box should be sealed. Yellow caps (included with the vacuum box) can be used to plug unused white tips to achieve good seal during the separation.

- 11.2.2.6. Add 5 mL of 3-M HNO_3 to the funnel to precondition the UTEVA cartridge.
11.2.2.7. Adjust the vacuum pressure to achieve a flow-rate of ~ 1 mL/min.

IMPORTANT: Unless otherwise specified in the procedure, use a flow rate of ~ 1 mL/min for load and strip solutions and ~ 3 mL/min for rinse solutions.

11.2.3. U separation from Pu, Am using UTEVA resin

- 11.2.3.1. Transfer each solution from Step 11.2.1.4 into the appropriate funnel by pouring or by using a plastic transfer pipette. Allow solution to pass through both the cartridges at a flow rate of ~ 1 mL/min.
11.2.3.2. Add 5 mL of 3-M HNO_3 to each beaker as a rinse and transfer each solution into the appropriate funnel (the flow rate can be adjusted to ~ 3 mL/min).
11.2.3.3. Add 5 mL of 3-M HNO_3 into each funnel as second column rinse (flow rate ~ 3 mL/min).

Note: Maintain the flow rate at ≤ 3 mL/min in the next several steps.

Note: If a high concentration of ^{210}Po is present in the sample an additional 3 M HNO_3 rinse is necessary to eliminate ^{210}Po . Add 30 mL of 3 M HNO_3 rinse to each UTEVA cartridge in increments of 10 mL. Continue with Step 11.2.3.4.

- 11.2.3.4. Pipette 5 mL of 9-M HCl into each UTEVA cartridge and allow it to drain. Discard this rinse.

Note: This rinse converts the resin to the chloride system. Some Np may be removed here.

- 11.2.3.5. Pipette 20 mL of 5-M HCl – 0.05 M oxalic acid into each UTEVA cartridge and allow it to drain. Discard this rinse.

Note: This rinse removes neptunium and thorium from the cartridge. The 9-M HCl and 5-M HCl – 0.05 M oxalic acid rinses also remove any residual ferrous ion that might interfere with micoprecipitation.

- 11.2.3.6. Ensure that clean, labeled tubes are placed in the tube rack.
11.2.3.7. Pipette 15 mL of 1-M HCl into each cartridge to strip the uranium. Allow to drain.

- 11.2.3.8. Transfer the eluate containing uranium to a 50-mL beaker. Rinse the tube with a few milliliters of water and add to the same beaker.
- 11.2.3.9. Evaporate samples to near soft dryness. If a slight white residue appears, wet-ash by adding a few mL of HNO_3 , heating till near dryness and repeating the process 2–3 times. Once wet-ashing is complete, convert the sample to the chloride form by treating it 2–3 times with 1–2-mL portions of HCl and evaporating to near dryness.

Note: Do not bake the residue.

- 11.2.3.10. Allow the beaker to cool slightly and then add a few drops of concentrated HCl followed by 1 mL of water.
- 11.2.3.11. Transfer the solution to a 10-mL plastic culture tube. Rinse the original sample vessel twice with 1-mL washes of 1-M HCl , transferring the rinses to a culture tube. Mix by gently swirling the solution in the tube.
- 11.2.3.12. Proceed to neodymium fluoride microprecipitation, Step 11.3.
- 11.2.3.13. Discard the UTEVA cartridge.

11.3. Preparation of the Sample Test Source

Note: Instructions below describe preparation of a single Sample Test Source. Several STSs can be prepared simultaneously if a multi-channel vacuum box (whale apparatus) is available.

- 11.3.1. Add 100 μL of the neodymium carrier solution to the culture tube with a micropipette. Gently swirl the tube to mix the solution.
- 11.3.2. Add four drops of 20% TiCl_3 solution to the tube and mix gently. A strong permanent violet color should appear. If the color fails to appear, add a few more drops of the TiCl_3 solution to provide the permanent violet color.
- 11.3.3. Add 1 mL of concentrated HF to the tube and mix well by gently swirling.
- 11.3.4. Cap the tube and place it in a cold-water ice bath for at least 30 minutes.
- 11.3.5. Insert the polysulfone filter stem in the 250-mL vacuum flask. Place the stainless steel screen on top of the fitted plastic filter stem.
- 11.3.6. Place a 25-mm polymeric filter face up on the stainless steel screen. Center the filter on the stainless steel screen support and apply vacuum. Wet the filter with 100 % ethanol, followed by filtered Type I water.

Caution: There is no visible difference between the two sides of the filter. If the filter is turned over accidentally, it is recommended that the filter be discarded and a fresh one removed from the container.

- 11.3.7. Lock the filter chimney firmly in place on the filter screen and wash the filter with additional filtered Type I water wash.
- 11.3.8. Pour 5.0 mL of neodymium substrate solution down the side of the filter chimney, avoiding directing the stream at the filter. When the solution passes through the filter, wait at least 15 seconds before the next step.
- 11.3.9. Repeat Step 11.3.8 with an additional 5.0 mL of the substrate solution.

- 11.3.10. Pour the sample from Step 11.3.4 down the side of the filter chimney and allow the vacuum to draw the solution through.
- 11.3.11. Rinse the tube twice with 2 mL of 0.58-M HF, stirring each wash briefly using a vortex mixer and pouring each wash down the side of the filter chimney.
- 11.3.12. Repeat rinse using 2-mL filtered Type I water once.
- 11.3.13. Repeat rinse using 2-mL 80% ethyl alcohol once.
- 11.3.14. Wash any drops remaining on the sides of the chimney down toward the filter with a few mL 80% ethyl alcohol.

Caution: Directing a stream of liquid onto the filter will disturb the distribution of the precipitate on the filter and render the sample unsuitable for α -spectrometry resolution.

- 11.3.15. Without turning off the vacuum, remove the filter chimney.
- 11.3.16. Turn off the vacuum to remove the filter. Discard the filtrate to waste for future disposal. If the filtrate is to be retained, it should be placed in a plastic container to avoid dissolution of the glass vessel by dilute HF.
- 11.3.17. Place the filter on a properly labeled mounting disc, secure with a mounting ring or other device that will render the filter flat for counting.
- 11.3.18. Let the sample air dry for a few minutes and when dry, place in a container suitable for transfer and submit for counting.
- 11.3.19. Count the sample on an alpha spectrometer.

Note: Other methods for STS preparation, such as electroplating or microprecipitation with cerium fluoride, may be used in lieu of the neodymium fluoride microprecipitation, but any such substitution must be validated as described in Section 1.4.

12. Data Analysis and Calculations

- 12.1. Equations for determination of final result, combined standard uncertainty and radiochemical yield (if required).

The activity concentration of an analyte and its combined standard uncertainty are calculated using the following equations:

$$AC_a = \frac{A_t \times R_a \times D_t \times I_t}{V_a \times R_t \times D_a \times I_a}$$

and

$$u_c(AC_a) = \sqrt{u^2(R_a) \times \frac{A_t^2 \times D_t^2 \times I_t^2}{V_a^2 \times R_t^2 \times D_a^2 \times I_a^2} + AC_a^2 \times \left(\frac{u^2(A_t)}{A_t^2} + \frac{u^2(V_a)}{V_a^2} + \frac{u^2(R_t)}{R_t^2} \right)}$$

where:

- AC_a = activity concentration of the analyte at time of count, (pCi/L)
- A_t = activity of the tracer added to the sample aliquant at its reference date and time, (pCi)
- R_a = net count rate of the analyte in the defined region of interest (ROI), in counts per second
- R_t = net count rate of the tracer in the defined ROI, in counts per second

V_a	=	volume of the sample aliquant, (L)
D_t	=	correction factor for decay of the tracer from its reference date and time to the midpoint of the counting period
D_a	=	correction factor for decay of the analyte from the time of sample collection (or other reference time) to the midpoint of the counting period (if required)
I_t	=	probability of α emission in the defined ROI, per decay of the tracer (Table 17.1)
I_a	=	probability of α emission in the defined ROI, per decay of the analyte (Table 17.1)
$u_c(AC_a)$	=	combined standard uncertainty of the activity concentration of the analyte (pCi/L)
$u(A_t)$	=	standard uncertainty of the activity of the tracer added to the sample (pCi)
$u(V_a)$	=	standard uncertainty of the volume of sample aliquant (L)
$u(R_a)$	=	standard uncertainty of the net count rate of the analyte, in counts per second
$u(R_t)$	=	standard uncertainty of the net count rate of the tracer, in counts per second

Note: The uncertainties of the decay-correction factors and of the probability of decay factors are assumed to be negligible.

Note: The equation for the combined standard uncertainty ($u_c(AC_a)$) calculation is arranged to eliminate the possibility of dividing by zero if $R_a = 0$.

Note: The standard uncertainty of the activity of the tracer added to the sample must reflect that associated with the activity of the standard reference material and any other significant sources of uncertainty such as those introduced during the preparation of the tracer solution (e.g., weighing or dilution factors) and during the process of adding the tracer to the sample.

12.1.1. The net count rate of an analyte or tracer and the associated standard uncertainties are calculated using the following equations:

$$R_x = \frac{C_x}{t_s} - \frac{C_{bx}}{t_b}$$

and

$$u(R_x) = \sqrt{\frac{C_x + 1}{t_s^2} + \frac{C_{bx} + 1}{t_b^2}}$$

where:

$u(R_x)$ = standard uncertainty of the net count rate of tracer or analyte, in counts per second¹

¹ For methods with very low counts, MARLAP Section 19.5.2.2 recommends adding one count each to the gross counts and the background counts when estimating the uncertainty of the respective net counts. This minimizes

R_x	=	net count rate of analyte or tracer, in counts per second
C_x	=	sample counts in the analyte or the tracer peak
t_s	=	sample count time (s)
C_{bx}	=	background counts in the same region of interest (ROI) as for x
t_b	=	background count time (s)

The radiochemical yield and the combined standard uncertainty can be estimated for each sample, when required, using the following equations:

$$RY = \frac{R_t}{0.037 \times A_t \times D_t \times I_t \times \varepsilon}$$

and

$$u(RY) = RY \times \sqrt{\frac{u^2(R_t)}{R_t^2} + \frac{u^2(A_t)}{A_t^2} + \frac{u^2(\varepsilon)}{\varepsilon^2}}$$

where:

RY	=	radiochemical yield of the tracer, expressed as a fraction
R_t	=	net count rate of the tracer, in counts per second
A_t	=	activity of the tracer added to the sample (pCi)
D_t	=	correction factor for decay of the tracer from its reference date and time to the midpoint of the counting period
I_t	=	probability of α emission in the defined ROI per decay of the tracer (Table 17.1)
ε	=	detector efficiency, expressed as a fraction
$u_c(RY)$	=	combined standard uncertainty of the radiochemical yield
$u(R_t)$	=	standard uncertainty of the net count rate of the tracer, in counts per second
$u(A_t)$	=	standard uncertainty of the activity of the tracer added to the sample (pCi)
$u(\varepsilon)$	=	standard uncertainty of the detector efficiency

12.1.2. If the critical level concentration (S_c) or the minimum detectable concentration (MDC) are requested (at an error rate of 5%), they can be calculated using the following equations:²

negative bias in the estimate of uncertainty and protects against calculating zero uncertainty when zero total counts are observed for the sample and background.

² The formulations for the critical level and minimum detectable concentration are based on the Stapleton Approximation as recommended in MARLAP Section 20A.2.2, Equations 20.54 and 20A.3.2, and Equation 20.74, respectively. The formulations presented here assume an error rate of $\alpha = 0.05$, $\beta = 0.05$ (with $z_{1-\alpha} = z_{1-\beta} = 1.645$), and $d = 0.4$. For methods with very low numbers of counts, these expressions provide better estimates than do the traditional formulas for the critical level and MDC.

$$S_c = \frac{\left[0.4 \times \left(\frac{t_s}{t_b} - 1 \right) + 0.677 \times \left(1 + \frac{t_s}{t_b} \right) + 1.645 \times \sqrt{(R_{ba} t_b + 0.4) \times \frac{t_s}{t_b} \times \left(1 + \frac{t_s}{t_b} \right)} \right] \times A_t \times D_t \times I_t}{t_s \times V_a \times R_t \times D_a \times I_a}$$

$$\text{MDC} = \frac{\left[2.71 \times \left(1 + \frac{t_s}{t_b} \right) + 3.29 \times \sqrt{R_{ba} t_s \times \left(1 + \frac{t_s}{t_b} \right)} \right] \times A_t \times D_t \times I_t}{t_s \times V_a \times R_t \times D_a \times I_a}$$

where:

R_{ba} = background count rate for the analyte in the defined ROI, in counts per second

12.2. Results Reporting

12.2.1. The following data should be reported for each result: volume of sample used, yield of tracer and its uncertainty, and FWHM of each peak used in the analysis.

12.2.2. The following conventions should be noted for each result:

12.2.2.1. Result in scientific notation \pm combined standard uncertainty.

12.2.2.2. If solid material was filtered from the solution and analyzed separately, the results of that analysis should be reported separately as pCi/L of the original volume from which the solids were filtered if no other guidance is provided on reporting of results for the solids.

For example:

^{238}U for Sample 12-1-99:

Filtrate Result: 12.8 ± 1.5 pCi/L

Filtered Residue Result: 2.5 ± 0.3 pCi/L

13. Method Performance

13.1. Method validation results are to be reported.

13.2. Expected turnaround time per batch of 14 samples plus QC, assuming microprecipitations for the whole batch are performed simultaneously using a vacuum box system:

13.2.1. For an analysis of a 200 mL sample aliquant, sample preparation and digestion should take ~ 3.5 h.

13.2.2. Purification and separation of the uranium fraction using cartridges and vacuum box system should take ~ 1.5 h.

13.2.3. The sample test source preparation takes ~ 1 h (longer if wet-ashing is necessary).

13.2.4. A 1-h counting time should be sufficient to meet the MQOs listed in 9.3 and 9.4, assuming detector efficiency of 0.2-0.3, and radiochemical yield of at least 0.5. A different counting time may be necessary to meet these MQOs if any of the relevant parameters are significantly different.

13.2.5. Data should be ready for reduction ~ 6 h after beginning of analysis.

14. Pollution Prevention: This method utilizes small volume (2 mL) extraction chromatographic resin columns. This approach leads to a significant reduction in the volumes of load, rinse and strip solutions, as compared to classical methods using ion exchange resins to separate and purify uranium.
15. Waste Management
 - 15.1. Types of waste generated per sample analyzed
 - 15.1.1. If calcium phosphate coprecipitation is performed, 100-1000 mL of decanted solution that is pH neutral is generated.
 - 15.1.2. Approximately 65 mL of acidic waste from loading and rinsing the extraction column will be generated. The solution may contain unknown quantities of radionuclides as may be present in the original sample. If presence of other radionuclides in the sample is suspected, combined effluents should be collected separately from other rinses to minimize quantity of mixed waste generated.
 - 15.1.3. Approximately 45 mL of slightly acidic waste, containing 1 mL of HF and ~ 8 mL ethanol are produced in the microprecipitation step.
 - 15.1.4. UTEVA cartridge – ready for appropriate disposal.
 - 15.2. Evaluate all waste streams to ensure that all local, state, and federal disposal requirements are met.
16. References
 - 16.1. ACW02, Rev. 1.3, “Uranium in Water,” Eichrom Technologies, Inc., Lisle, Illinois (April 2001).
 - 16.2. G-03, V.1 “Microprecipitation Source Preparation for Alpha Spectrometry,” HASL-300, 28th Edition, (February 1997).
 - 16.3. ASTM D7282 “Standard Practice for Set-up, Calibration, and Quality Control of Instruments Used for Radioactivity Measurements,” ASTM Book of Standards 11.02, current version, ASTM International, West Conshohocken, PA.
 - 16.4. VBS01, “Setup and Operation Instructions for Eichrom’s Vacuum Box System (VBS),” Eichrom Technologies, Inc., Lisle, Illinois (Rev. 1.3, January 30, 2004).
 - 16.5. U.S. Environmental Protection Agency (EPA). 2009. *Method Validation Guide for Radiological Laboratories Participating in Incident Response Activities*. Revision 0. Office of Air and Radiation, Washington, DC. EPA 402-R-09-006, June. Available at: www.epa.gov/narel/incident_guides.html.
 - 16.6. *Multi-Agency Radiological Laboratory Analytical Protocols Manual (MARLAP)*. 2004. EPA 402-B-1304 04-001A, July. Volume I, Chapters 6, 7, 20, Glossary; Volume II and Volume III, Appendix G. Available at: www.epa.gov/radiation/marlap/index.html.
 - 16.7. ASTM D1193, “Standard Specification for Reagent Water” ASTM Book of Standards 11.01, current version, ASTM International, West Conshohocken, PA.

17. Tables, Diagrams, Flow Charts, and Validation Data

17.1. Nuclide Decay and Radiation Data

Table 17.1 – Decay and Radiation Data

Nuclide	Half-Life (Years)	λ (s^{-1})	Abundance	α Energy (MeV)
^{238}U	4.468×10^9	4.916×10^{-18}	0.79	4.198
			0.21	4.151
^{235}U	7.038×10^8	3.121×10^{-17}	0.050	4.596
			0.042	4.556
			0.0170	4.502
			0.0070	4.435
			0.0210	4.414
			0.55	4.398
			0.170	4.366
^{234}U	2.457×10^5	8.940×10^{-14}	0.7138	4.775
			0.2842	4.722
			0.002	4.604
^{232}U	68.9	3.19×10^{-10}	0.6815	5.320
			0.3155	5.263

17.2. Ingrowth Curves and Ingrowth Factors

This section intentionally left blank

17.3. Spectrum from a Processed Sample

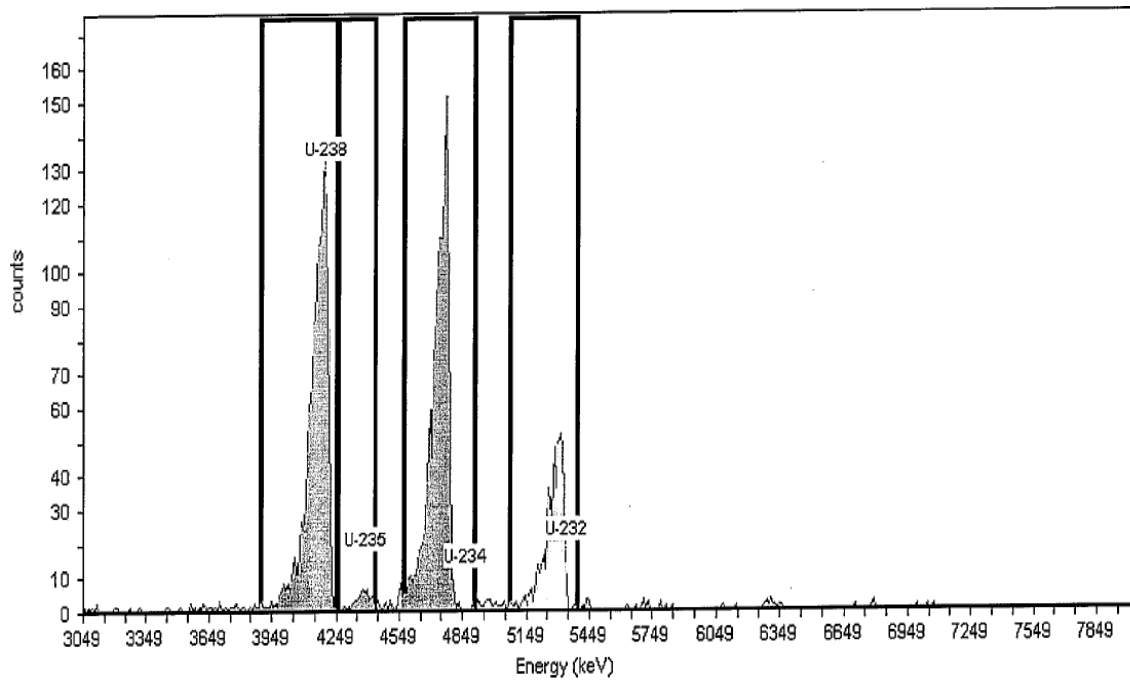

17.4. Decay Scheme: Ingrowth is not generally a large concern with this analysis unless one is running sequential analysis for uranium and plutonium with ^{236}Pu tracer (due to ingrowth of ^{232}U tracer) or sequential analyses for uranium and thorium (due to ^{228}Th tracer ingrowth in the ^{232}U tracer).

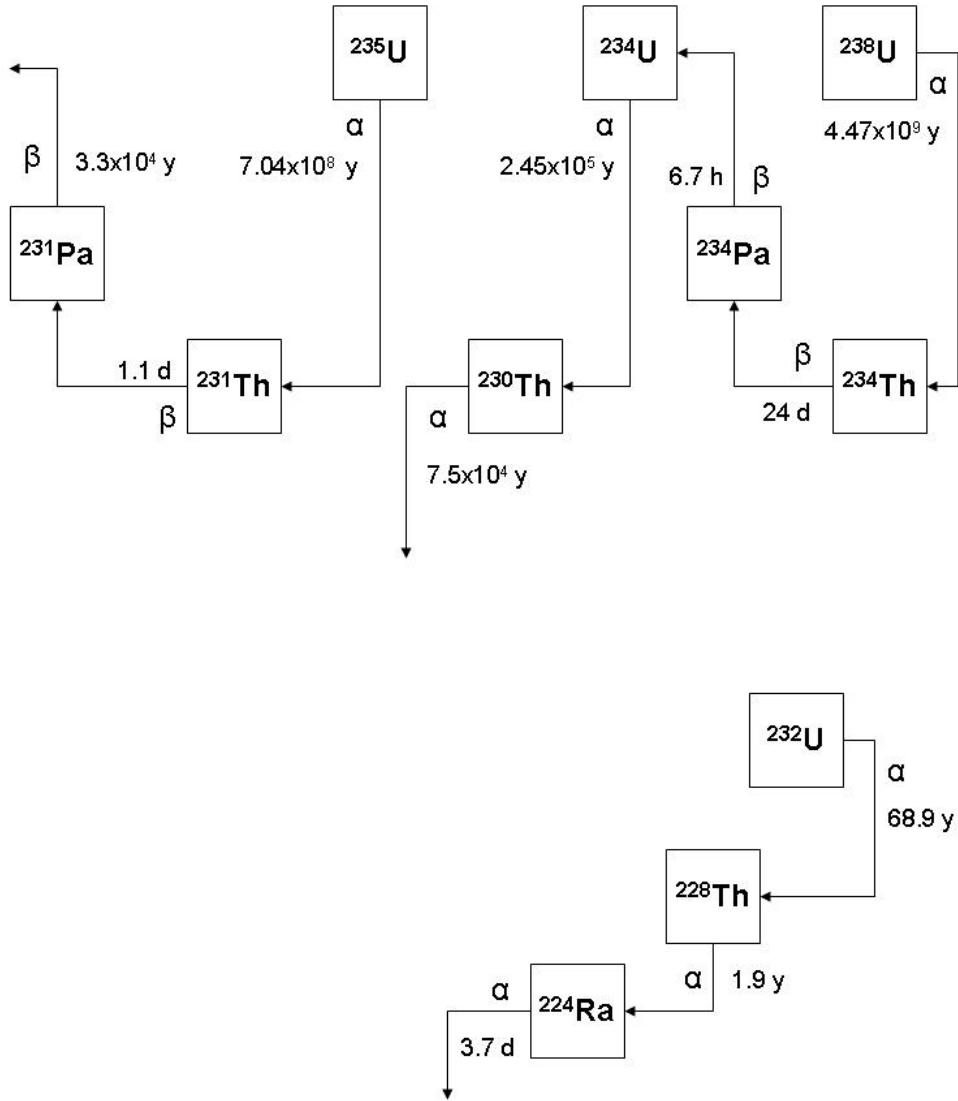

17.5. Flow Chart

Separation Scheme and Timeline for Determination of U Isotopes in Water Samples

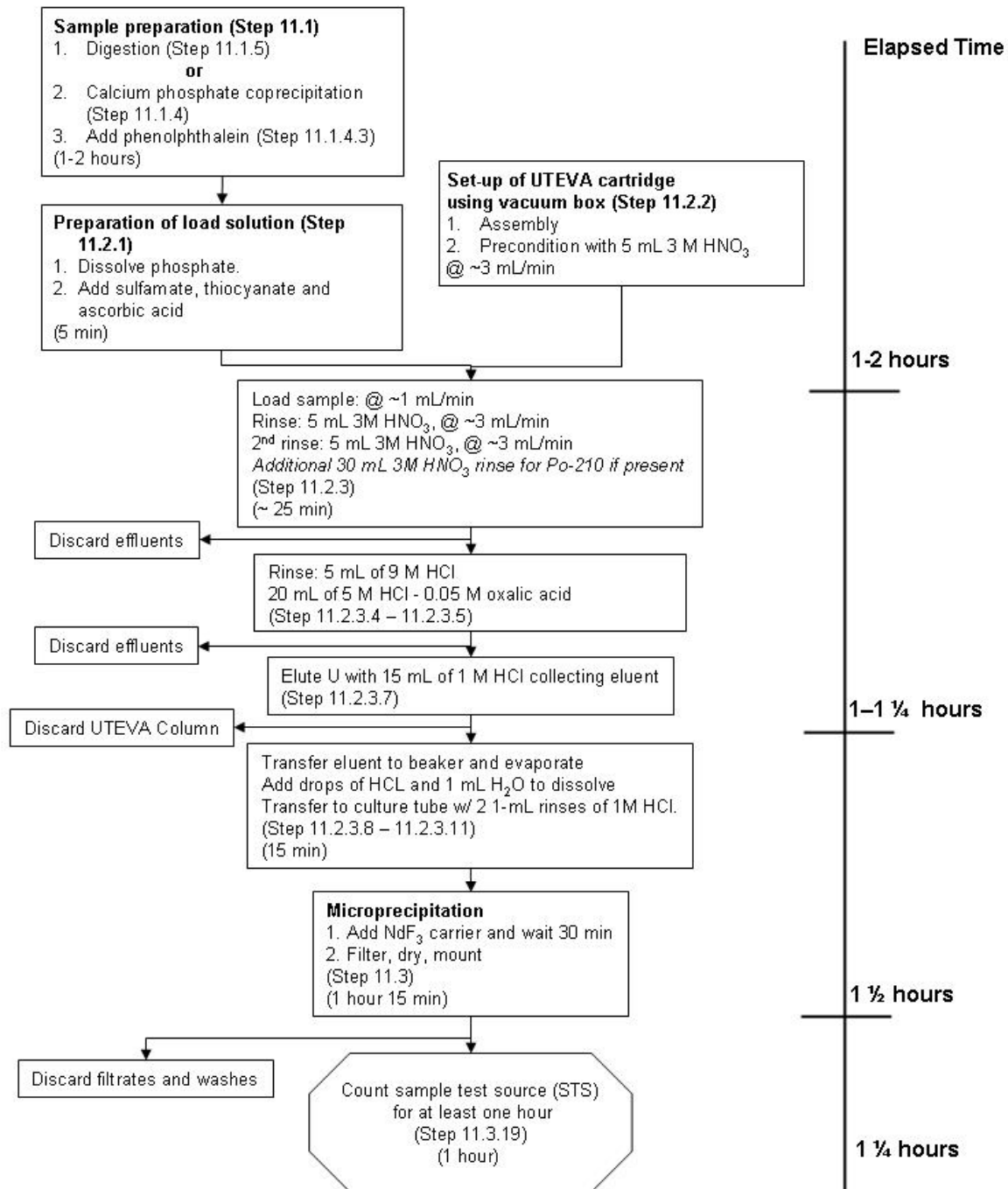

Appendix

Table A1 – Composition of Atlanta Drinking Water Used for this Study

Metals by ICP-AES	Concentration (mg/L)*
Silicon	3.18
Aluminum	<0.200
Barium	0.0133
Calcium	9.38
Iron	<0.100
Magnesium	<0.500
Potassium	<0.500
Sodium	<0.500
Inorganic Anions	
Chloride	12.7
Sulfate	15.6
Nitrogen, Nitrate (as N)	1.19
Carbon Dioxide	
Bicarbonate Alkalinity	23.8
Carbonate Alkalinity	<3.00
Radionuclide	Concentration (pCi/L)**
Uranium 234, 235, 238	<0.01, <0.01, <0.01
Plutonium 238, 239/240	<0.02, <0.02
Americium 241	<0.02
Strontium 90	<0.3
Radium 226***	0.11 ± 0.27 -0.30 ± 0.45

Note: Analyses conducted by independent laboratories.

* Values below the reporting level are presented as less than (<) values.

No measurement uncertainty was reported with values greater than the “Reporting Level.”

** Reported values represent the calculated minimum detectable concentration (MDC) for the radionuclide(s).

*** Two samples analyzed.



Recycled/Recyclable • Printed on 100% Postconsumer, Process Chlorine Free Recycled Paper