

**Compendium of Methods
for the Determination of
Toxic Organic Compounds
in Ambient Air**

Second Edition

Compendium Method TO-4A

**Determination of Pesticides and
Polychlorinated Biphenyls in Ambient
Air Using High Volume Polyurethane
Foam (PUF) Sampling Followed by
Gas Chromatographic/Multi-Detector
Detection (GC/MD)**

**Center for Environmental Research Information
Office of Research and Development
U.S. Environmental Protection Agency
Cincinnati, OH 45268**

January 1999

Method TO-4A Acknowledgements

This Method was prepared for publication in the *Compendium of Methods for the Determination of Toxic Organic Compounds in Ambient Air, Second Edition* (EPA/625/R-96/010b), which was prepared under Contract No. 68-C3-0315, WA No. 3-10, by Midwest Research Institute (MRI), as a subcontractor to Eastern Research Group, Inc. (ERG), and under the sponsorship of the U.S. Environmental Protection Agency (EPA). Justice A. Manning, John O. Burckle, and Scott R. Hedges, Center for Environmental Research Information (CERI), and Frank F. McElroy, National Exposure Research Laboratory (NERL), all in the EPA Office of Research and Development (ORD), were responsible for overseeing the preparation of this method. Additional support was provided by other members of the Compendia Workgroup, which include:

- John O. Burckle, U.S. EPA, ORD, Cincinnati, OH
- James L. Cheney, Corps of Engineers, Omaha, NB
- Michael Davis, U.S. EPA, Region 7, KC, KS
- Joseph B. Elkins Jr., U.S. EPA, OAQPS, RTP, NC
- Robert G. Lewis, U.S. EPA, NERL, RTP, NC
- Justice A. Manning, U.S. EPA, ORD, Cincinnati, OH
- William A. McClenny, U.S. EPA, NERL, RTP, NC
- Frank F. McElroy, U.S. EPA, NERL, RTP, NC
- Heidi Schultz, ERG, Lexington, MA
- William T. "Jerry" Winberry, Jr., EnviroTech Solutions, Cary, NC

Method TO-4 was originally published in April of 1984 as one of a series of peer reviewed methods in "*Compendium of Methods for the Determination of Toxic Organic Compounds in Ambient Air*," EPA 600/4-89-018. In an effort to keep these methods consistent with current technology, Method TO-4 has been revised and updated as Method TO-4A in this Compendium to incorporate new or improved sampling and analytical technologies. In addition, this method incorporates ASTM Method D 4861-94, *Standard Practice for Sampling and Analysis of Pesticides and Polychlorinated Biphenyls in Air*.

This Method is the result of the efforts of many individuals. Gratitude goes to each person involved in the preparation and review of this methodology.

Author(s)

- William T. "Jerry" Winberry, Jr., EnviroTech Solutions, Cary, NC
- Ralph Riggin, Battelle Laboratories, Columbus, OH
- Robert G. Lewis, U.S. EPA, NERL, RTP, NC

Peer Reviewers

- Irene D. DeGraff, Supelco, Bellefonte, PA
- Ronald A. Hiles, Indiana University, Bloomington, IN
- Lauren Drees, U.S. EPA, NRMRL, Cincinnati, OH

Finally, recognition is given to Frances Beyer, Lynn Kaufman, Debbie Bond, Cathy Whitaker, and Kathy Johnson of Midwest Research Institute's Administrative Services staff whose dedication and persistence during the development of this manuscript has enabled it's production.

DISCLAIMER

This Compendium has been subjected to the Agency's peer and administrative review, and it has been approved for publication as an EPA document. Mention of trade names or commercial products does not constitute endorsement or recommendation for use.

METHOD TO-4A

Determination of Pesticides and Polychlorinated Biphenyls in Ambient Air Using High Volume Polyurethane Foam (PUF) Sampling Followed by Gas Chromatographic/Multi-Detector Detection (GC/MD)

TABLE OF CONTENTS

	<u>Page</u>
1. Scope	4A-1
2. Summary of Method	4A-1
3. Significance	4A-2
4. Applicable Documents	4A-2
4.1 ASTM Standards	4A-2
4.2 EPA Documents	4A-2
4.3 Other Documents	4A-3
5. Definitions	4A-3
6. Interferences	4A-4
7. Safety	4A-4
8. Apparatus	4A-5
8.1 Sampling	4A-5
8.2 Sample Clean-up and Concentration	4A-6
8.3 Sample Analysis	4A-7
9. Equipment and Materials	4A-7
9.1 Materials for Sample Collection	4A-7
9.2 Sample Extraction and Concentration	4A-8
9.3 GC/MS Sample Analysis	4A-8
10. Preparation of PUF Sampling Cartridge	4A-9
10.1 Summary of Method	4A-9
10.2 Preparation of Sampling Cartridge	4A-9
10.3 Procedure for Certification of PUF Cartridge Assembly	4A-10
11. Assembly, Calibration and Collection Using High-Volume Sampling System	4A-11
11.1 Description of Sampling Apparatus	4A-11
11.2 Calibration of Sampling System	4A-11
11.3 Sample Collection	4A-18

TABLE OF CONTENTS (continued)

	<u>Page</u>
12. Sample Extraction Procedure	4A-20
12.1 Sample Extraction	4A-20
12.2 Sample Cleanup	4A-21
13. Analytical Procedure	4A-22
13.1 Analysis Organochlorine Pesticides by Capillary Gas Chromatography with Electron Capture Detector (GC/ECD)	4A-22
13.2 Analysis of Organophosphorus Pesticides by Capillary Gas Chromatography with Flame Photometric or Nitrogen-Phosphorus Detectors (GC/FPD/NPD)	4A-23
13.3 Analysis of Carbamate and Urea Pesticides by Capillary Gas Chromatography with Nitrogen-Phosphorus Detector	4A-23
13.4 Analysis of Carbamate, Urea, Pyrethroid, and Phenolic Pesticides by High Performance Liquid Chromatography (HPLC)	4A-24
13.5 Analysis of Pesticides and PCBs by Gas Chromatography with Mass Spectrometry Detection (GC/MS)	4A-24
13.6 Sample Concentration	4A-25
14. Calculations	4A-25
14.1 Determination of Concentration	4A-25
14.2 Equations	4A-25
15. Performance Criteria and Quality Assurance	4A-27
15.1 Standard Operating Procedures (SOPs)	4A-28
15.2 Process, Field, and Solvent Blanks	4A-28
15.3 Method Precision and Bias	4A-28
15.4 Method Safety	4A-29
16. References	4A-29

METHOD TO-4A

Determination of Pesticides and Polychlorinated Biphenyls in Ambient Air Using High Volume Polyurethane Foam (PUF) Sampling Followed by Gas Chromatographic/Multi-Detector Detection (GC/MD)

1. Scope

1.1 This document describes a method for sampling and analysis of a variety of common pesticides and for polychlorinated biphenyls (PCBs) in ambient air. The procedure is based on the adsorption of chemicals from ambient air on polyurethane foam (PUF) using a high volume sampler.

1.2 The high volume PUF sampling procedure is applicable to multicomponent atmospheres containing common pesticide concentrations from 0.001 to 50 $\mu\text{g}/\text{m}^3$ over 4- to 24-hour sampling periods. The limits of detection will depend on the nature of the analyte and the length of the sampling period.

1.3 Specific compounds for which the method has been employed are listed in Table 1. The analytical methodology described in Compendium Method TO-4A is currently employed by laboratories throughout the U.S. The sampling methodology has been formulated to meet the needs of common pesticide and PCB sampling in ambient air.

1.4 Compendium Method TO-4 was originally published in 1989 (1). Further updates of the sampling protocol were published as part of Compendium Method TO-13 (2). The method was further modified for indoor air application in 1990 (3). In an effort to keep the method consistent with current technology, Compendium Method TO-4 has incorporated the sampling and analytical procedures in ASTM Method D4861-94 (4) and is published here as Compendium Method TO-4A.

2. Summary of Method

2.1 A high-volume (~8 cfm) sampler is used to collect common pesticides and PCBs on a sorbent cartridge containing PUF. Airborne particles may also be collected, but the sampling efficiency is not known (5). The sampler is operated for 24-hours, after which the sorbent is returned to the laboratory for analysis.

2.2 Pesticides and PCBs are extracted from the sorbent cartridge with 10 percent diethyl ether in hexane and determined by gas chromatography coupled with an electron capture detector (ECD), nitrogen-phosphorus detector (NPD), flame photometric detector (FPD), Hall electrolytic conductivity detector (HECD), or a mass spectrometer (MS). For common pesticides, high performance liquid chromatography (HPLC) coupled with an ultraviolet (UV) detector or electrochemical detector may be preferable.

2.3 Interferences resulting from analytes having similar retention times during GC analysis are resolved by improving the resolution or separation, such as by changing the chromatographic column or operating parameters, or by fractionating the sample by column chromatography.

3. Significance

3.1 Pesticide usage and environmental distribution are common to rural and urban areas of the United States. The application of pesticides can cause adverse health effects to humans by contaminating soil, water, air, plants, and animal life. PCBs are less widely used, due to extensive restrictions placed on their manufacturer. However, human exposure to PCBs continues to be a problem because of their presence in various electrical products.

3.2 Many pesticides and PCBs exhibit bioaccumulative, chronic health effects; therefore, monitoring the presence of these compounds in ambient air is of great importance.

3.3 The relatively low levels of such compounds in the environment requires the use of high volume sampling techniques to acquire sufficient sample for analysis. However, the volatility of these compounds prevents efficient collection on filter media. Consequently, Compendium Method TO-4A utilizes both a filter and a PUF backup cartridge which provides for efficient collection of most common pesticides, PCBs, and many other organics within the same volatility range.

3.4 Moreover, modifications to this method has been successfully applied to measurement of common pesticides and PCBs in outdoor air (6), indoor air (3) and for personal respiratory exposure monitoring (3).

4. Applicable Documents

4.1 ASTM Standards

- D1356 *Definition of Terms Relating to Atmospheric Sampling and Analysis*
- D4861-94 *Standard Practice for Sampling and Analysis of Pesticides and Polychlorinated Biphenyls in Air*
- E260 *Recommended Practice for General Gas Chromatography Procedures*
- E355 *Practice for Gas Chromatography Terms and Relationships*
- D3686 *Practice for Sampling Atmospheres to Collect Organic Compound Vapors (Activated Charcoal Tube Adsorption Method)*
- D3687 *Practice for Analysis of Organic Compound Vapors Collected by the Activated Charcoal Tube Adsorption*
- D4185 *Practice for Measurement of Metals in Workplace Atmosphere by Atomic Absorption Spectrophotometry*

4.2 EPA Documents

- *Compendium of Methods for the Determination of Toxic Organic Compounds in Ambient Air: Method TO-10, Second Supplement*, U. S. Environmental Protection Agency, EPA 600/4-89-018, March 1989.
- *Manual of Analytical Methods for Determination of Pesticides in Humans and Environmental Standards*, U. S. Environmental Protection Agency, EPA 600/8-80-038, June 1980.
- *Compendium of Methods for the Determination of Air Pollutants in Indoor Air: Method IP-8*, U. S. Environmental Protection Agency, EPA 600/4-90-010, May 1990.

4.3 Other Documents

- Code of Federal Regulations, Title 40, Part 136, Method 604

5. Definitions

[Note: Definitions used in this document and in any user-prepared Standard operating procedures (SOPs) should be consistent with ASTM D1356, E260, and E355. All abbreviations and symbols are defined within this document at point of use.]

5.1 Sampling efficiency (SE)-ability of the sampling medium to trap analytes of interest. The percentage of the analyte of interest collected and retained by the sampling medium when it is introduced as a vapor in air or nitrogen into the air sampler and the sampler is operated under normal conditions for a period of time equal to or greater than that required for the intended use is indicated by %SE.

5.2 Retention efficiency (RE)-ability of sampling medium to retain a compound added (spiked) to it in liquid solution.

5.3 Retention time (RT)-time to elute a specific chemical from a chromatographic column, for a specific carrier gas flow rate, measured from the time the chemical is injected into the gas stream until it appears at the detector.

5.4 Relative retention time (RRT)-a ratio of RTs for two chemicals for the same chromatographic column and carrier gas flow rate, where the denominator represents a reference chemical.

5.5 Method detection limit (MDL)-the minimum concentration of a substance that can be measured and reported with confidence and that the value is above zero.

5.6 Kuderna-Danish apparatus-the Kuderna-Danish (K-D) apparatus is a system for concentrating materials dissolved in volatile solvents.

5.7 MS-SIM-the GC is coupled to a mass spectrometer where the instrument is programmed to acquire data for only the target compounds and to disregard all others, thus operating in the select ion monitoring mode (SIM). This is performed using SIM coupled to retention time discriminators. The SIM analysis procedure provides quantitative results.

5.8 Sublimation-the direct passage of a substance from the solid state to the gaseous state and back into the solid form without any time appearing in the liquid state. Also applied to the conversion of solid to vapor without the later return to solid state, and to a conversion directly from the vapor phase to the solid state.

5.9 Surrogate standard-a chemically compound (not expected to occur in the environmental sample) which is added to each sample, blank and matrix spiked sample before extraction and analysis. The recovery of the surrogate standard is used to monitor unusual matrix effects, gross sample processing errors, etc. Surrogate recovery is evaluated for acceptance by determining whether the measured concentration falls within acceptable limits.

6. Interferences

6.1 Any gas or liquid chromatographic separation of complex mixtures of organic chemicals is subject to serious interference problems due to coelution of two or more compounds. The use of capillary or microbore columns with superior resolution or two or more columns of different polarity will frequently eliminate these problems. In addition, selectivity may be further enhanced by use of a MS operated in the selected ion monitoring (SIM) mode as the GC detector. In this mode, co-eluting compounds can often be determined.

6.2 The ECD responds to a wide variety of organic compounds. It is likely that such compounds will be encountered as interferences during GC/ECD analysis. The NPD, FPD, and HECD detectors are element specific, but are still subject to interferences. UV detectors for HPLC are nearly universal, and the electrochemical detector may also respond to a variety of chemicals. Mass spectrometric analyses will generally provide positive identification of specific compounds.

6.3 PCBs and certain common pesticides (e.g., chlordane) are complex mixtures of individual compounds which can cause difficulty in accurately quantifying a particular formulation in a multiple component mixture. PCBs may interfere with the determination of pesticides.

6.4 Contamination of glassware and sampling apparatus with traces of pesticides or PCBs can be a major source of error, particularly at lower analyte concentrations. Careful attention to cleaning and handling procedures is required during all steps of sampling and analysis to minimize this source of error.

6.5 The general approaches listed below should be followed to minimize interferences.

6.5.1 Polar compounds, including certain pesticides (e.g., organophosphorus and carbamate classes) can be removed by column chromatography on alumina. Alumina clean-up will permit analysis of most common pesticides and PCBs (7).

6.5.2 PCBs may be separated from other common pesticides by column chromatography on silicic acid (8,9).

6.5.3 Many pesticides can be fractionated into groups by column chromatography on Florisil (9).

7. Safety

7.1 The toxicity or carcinogenicity of each reagent used in this method has not been precisely defined; however, each chemical compound should be treated as a potential health hazard. From this viewpoint, exposure to these chemicals must be reduced to the lowest possible level by whatever means available. The laboratory is responsible for maintaining a current awareness file of Occupational Safety and Health Administration (OSHA) regulations regarding the safe handling of the chemicals specified in this method. A reference file of material data handling sheets should also be made available to all personnel involved in the chemical analysis. Additional references to laboratory safety are available and have been identified for the analyst (10-12).

7.2 PCBs have been classified as a known or suspected, human or mammalian carcinogen. Many of the other common pesticides have been classified as carcinogens. Care must be exercised when working with these substances. This method does not purport to address all safety problems associated with its use. It is the responsibility of whoever uses this method to consult and establish appropriate safety and health practices and

determine the applicability of regulatory limitations prior to use. The user should be thoroughly familiar with the chemical and physical properties of targeted substances.

7.3 Treat all target analytes as carcinogens. Neat compounds should be weighed in a glove box. Spent samples and unused standards are toxic waste and should be disposed according to regulations. Regularly check counter tops and equipment with "black light" for fluorescence as an indicator of contamination.

7.4 The collection efficiency for common pesticides and PCBs has been demonstrated to be greater than 95 percent for the sampling configuration described in the method (filter and backup adsorbent). Therefore, no field recovery evaluation will occur as part of this procedure.

8. Apparatus

[Note: This method was developed using the PS-1 semi-volatile sampler provided by General Metal Works, Village of Cleves, OH as a guideline. EPA has experience in use of this equipment during various field monitoring programs over the last several years. Other manufacturers' equipment should work as well. However, modifications to these procedures may be necessary if another commercially available sampler is selected.]

8.1 Sampling

8.1.1 High-volume sampler (see Figure 1). Capable of pulling ambient air through the filter/adsorbent cartridge at a flow rate of approximately 8 standard cubic feet per minute (scfm) (0.225 std m³/min) to obtain a total sample volume of greater than 300 scm over a 24-hour period. Major manufacturers are:

- Tisch Environmental, Village of Cleves, OH
- Andersen Instruments Inc., 500 Technology Ct., Smyrna, GA
- Thermo Environmental Instruments, Inc., 8 West Forge Parkway, Franklin, MA

8.1.2 Sampling module (see Figure 2). Metal filter holder (Part 2) capable of holding a 102-mm circular particle filter supported by a 16-mesh stainless-steel screen and attaching to a metal cylinder (Part 1) capable of holding a 65-mm O.D. (60-mm I.D.) x 125-mm borosilicate glass sorbent cartridge containing PUF. The filter holder is equipped with inert sealing gaskets (e.g., polytetrafluorethylene) placed on either side of the filter. Likewise, inert, pliable gaskets (e.g., silicone rubber) are used to provide an air-tight seal at each end of the glass sorbent cartridge. The glass sorbent cartridge is indented 20 mm from the lower end to provide a support for a 16-mesh stainless-steel screen that holds the sorbent. The glass sorbent cartridge fits into Part 1, which is screwed onto Part 2 until the sorbent cartridge is sealed between the silicone gaskets. Major manufacturers are:

- Tisch Environmental, Village of Cleves, OH
- Andersen Instruments Inc., 500 Technology Ct., Smyrna, GA
- Thermo Environmental Instruments, Inc., 8 West Forge Parkway, Franklin, MA

A field portable unit has been developed by EPA (see Figure 3).

8.1.3 High-volume sampler calibrator. Capable of providing multipoint resistance for the high-volume sampler. Major manufacturers are:

- Tisch Environmental, Village of Cleves, OH
- Andersen Instruments Inc., 500 Technology Ct., Smyrna, GA
- Thermo Environmental Instruments, Inc., 8 West Forge Parkway, Franklin, MA

8.1.4 Ice chest. To hold samples at $<4^{\circ}\text{C}$ or below during shipment to the laboratory after collection.

8.1.5 Data sheets. For each sample for recording the location and sample time, duration of sample, starting time, and volume of air sampled.

8.2 Sample Clean-up and Concentration (see Figure 4).

8.2.1 Soxhlet apparatus extractor (see Figure 4a). Capable of extracting filter and adsorbent cartridges (2.3" x 5" length), 1,000 mL flask, and condenser, best source.

8.2.2 Pyrex glass tube furnace system. For activating silica gel at 180°C under purified nitrogen gas purge for an hour, with capability of raising temperature gradually, best source.

8.2.3 Glass vial. 40 mL, best source.

8.2.4 Erlenmeyer flask. 50 mL, best source.

[Note: Reuse of glassware should be minimized to avoid the risk of cross contamination. All glassware that is used, especially glassware that is reused, must be scrupulously cleaned as soon as possible after use. Rinse glassware with the last solvent used in it and then with high-purity acetone and hexane. Wash with hot water containing detergent. Rinse with copious amount of tap water and several portions of distilled water. Drain, dry, and heat in a muffle furnace at 400°C for 4 hours. Volumetric glassware must not be heated in a muffle furnace; rather, it should be rinsed with high-purity acetone and hexane. After the glassware is dry and cool, rinse it with hexane, and store it inverted or capped with solvent-rinsed aluminum foil in a clean environment.]

8.2.5 White cotton gloves. For handling cartridges and filters, best source.

8.2.6 Minivials. 2 mL, borosilicate glass, with conical reservoir and screw caps lined with Teflon®-faced silicone disks, and a vial holder, best source.

8.2.7 Teflon®-coated stainless steel spatulas and spoons. Best source.

8.2.8 Kuderna-Danish (K-D) apparatus (see Figure 4b). 500 mL evaporation flask (Kontes K-570001-500 or equivalent), 10 mL graduated concentrator tubes (Kontes K570050-1025 or equivalent) with ground-glass stoppers, and 3-ball macro Snyder Column (Kontes K-570010500, K-50300-0121, and K-569001-219, or equivalent), best source.

8.2.9 Adsorption column for column chromatography (see Figure 4c). 1-cm x 10-cm with stands.

8.2.10 Glove box. For working with extremely toxic standards and reagents with explosion-proof hood for venting fumes from solvents, reagents, etc.

8.2.11 Vacuum oven. Vacuum drying oven system capable of maintaining a vacuum at 240 torr (flushed with nitrogen) overnight.

8.2.12 Concentrator tubes and a nitrogen evaporation apparatus with variable flow rate. Best source.

8.2.13 Laboratory refrigerator. Best source.

8.2.14 Boiling chips. Solvent extracted, 10/40 mesh silicon carbide or equivalent, best source.

8.2.15 Water bath. Heated, with concentric ring cover, capable of $\pm 5^{\circ}\text{C}$ temperature control, best source.

8.2.16 Nitrogen evaporation apparatus. Best source.

8.2.17 Glass wool. High purity grade, best source.

8.3 Sample Analysis

8.3.1 Gas chromatograph (GC). The GC system should be equipped with appropriate detector(s) and either an isothermally controlled or temperature programmed heating oven. Improved detection limits may be obtained with a GC equipped with a cool on-column or splitless injector.

8.3.2 Gas chromatographic column. As an example, a 0.32-mm (I.D.) x 3-mm DB-5, DB-17, DB-608, DB-1701 are available. Other columns may also provide acceptable results.

8.3.3 HPLC column. As an example, a 4.6-mm x 25-cm Zorbax SIL or μ Bondpak C-18. Other columns may also provide acceptable results.

8.3.4 Microsyringes. 5 μ L volume or other appropriate sizes.

8.3.5 Balance. Mettler balance or equivalent.

8.3.6 All required syringes, gases, and other pertinent supplies. To operate the GC/MS system.

8.3.7 Pipettes, micropipettes, syringes, burets, etc. To make calibration and spiking solutions, dilute samples if necessary, etc., including syringes for accurately measuring volumes such as 25 μ L and 100 μ L.

9. Equipment and Materials

9.1 Materials for Sample Collection (see Figure 5)

9.1.1 Quartz fiber filter. 102-millimeter bindless quartz microfiber filter, Whatman Inc., 6 Just Road, Fairfield, NJ 07004, Filter Type QMA-4.

9.1.2 Polyurethane foam (PUF) plugs (see Figure 5a). 3-inch thick sheet stock polyurethane type (density .022 g/cm³). The PUF should be of the polyether type used for furniture upholstery, pillows, and mattresses. The PUF cylinders (plugs) should be slightly larger in diameter than the internal diameter of the cartridge. Sources of equipment are Tisch Environmental, Village of Cleves, OH; University Research Glassware, 116 S. Merritt Mill Road, Chapel Hill, NC; Thermo Environmental Instruments, Inc., 8 West Forge Parkway, Franklin, MA; Supelco, Supelco Park, Bellefonte, PA; and SKC Inc., 334 Valley View Road, Eighty Four, PA.

9.1.3 Teflon® end caps (see Figure 5a). For sample cartridge. Sources of equipment are Tisch Environmental, Village of Cleves, OH and University Research Glassware, Chapel Hill, NC.

9.1.4 Sample cartridge aluminum shipping containers (see Figure 5b). For sample cartridge shipping. Sources of equipment are Tisch Environmental, Village of Cleves, OH and University Research Glassware, Chapel Hill, NC.

9.1.5 Glass sample cartridge (see Figure 5a). For sample collection. Sources of equipment are Tisch Environmental, Village of Cleves, OH; Thermo Environmental Instruments, Inc., 8 West Forge Parkway, Franklin, MA; University Research Glassware, 116 S. Merritt Mill Road, Chapel Hill, NC; and Supelco, Supelco Park, Bellefonte, PA.

9.1.6 Aluminum foil. Best source.

9.1.7 Hexane, reagent grade. Best source.

9.2 Sample Extraction and Concentration

9.2.1 Methylene chloride. Chromatographic grade, glass-distilled, best source.

9.2.2 Sodium sulfate-anhydrous (ACS). Granular (purified by washing with methylene chloride followed by heating at 400°C for 4 hours in a shallow tray).

9.2.3 Boiling chips. Solvent extracted or heated in a muffle furnace at 450°C for 2 hours, approximately 10/40 mesh (silicon carbide or equivalent).

- 9.2.4 Nitrogen.** High purity grade, best source.
- 9.2.5 Ether.** Chromatographic grade, glass-distilled, best source.
- 9.2.6 Hexane.** Chromatographic grade, glass-distilled, best source.
- 9.2.7 Dibromobiphenyl.** Chromatographic grade, best source. Used for internal standard.
- 9.2.8 Decafluorobiphenyl.** Chromatographic grade, best source. Used for internal standard.
- 9.2.9 Glass wool.** Silanized, extracted with methylene chloride and hexane, and dried.
- 9.2.10 Diethyl ether.** High purity, glass distilled.
- 9.2.11 Hexane.** High purity, glass distilled.
- 9.2.12 Silica gel.** High purity, type 60, 70-230 mesh.
- 9.2.13 Round bottom evaporative flask.** 500 mL, T 24/40 joints, best source.
- 9.2.14 Capacity soxhlet extractors.** 500 mL, with reflux condensers, best source.
- 9.2.15 Kuderna-Danish concentrator.** 500 mL, with Snyder columns, best source.
- 9.2.16 Graduated concentrator tubes.** 10 mL, with 19/22 stoppers, best source.
- 9.2.17 Graduated concentrator tubes.** 1 mL, with 14/20 stoppers, best source.
- 9.2.18 TFE fluorocarbon tape.** 1/2 in., best source.
- 9.2.19 Filter tubes.** Size 40-mm (I.D.) x 80-mm.
- 9.2.20 Serum vials.** 1 mL and 5 mL, fitted with caps lined with TFE fluorocarbon.
- 9.2.21 Pasteur pipetter.** 9 in., best source.
- 9.2.22 Glass wool.** Fired at 500°C, best source.
- 9.2.23 Alumina.** Activity Grade IV, 100/200 mesh.
- 9.2.24 Glass chromatographic column.** 2-mm I.D. x 15-cm long.
- 9.2.25 Vacuum oven.** Connected to water aspirator, best source.
- 9.2.26 Die.** Best source.
- 9.2.27 Ice chest.** Best source.
- 9.2.28 Silicic Acid.** Pesticide quality, best source.
- 9.2.29 Octachloronaphthalene (OCN).** Research grade, best source.
- 9.2.30 Florisil.** Pesticide quality, best source.

9.3 GC Sample Analysis

9.3.1 Gas cylinders of hydrogen, nitrogen, argon/methane, and helium. Ultra high purity, best source.

9.3.2 Combustion air. Ultra high purity, best source.

9.3.3 Zero air. Zero air may be obtained from a cylinder or zero-grade compressed air scrubbed with Drierite® or silica gel and 5A molecular sieve or activated charcoal, or by catalytic cleanup of ambient air. All zero air should be passed through a liquid argon cold trap for final cleanup.

9.3.4 Chromatographic-grade stainless steel tubing and stainless steel fitting. For interconnections, Alltech Applied Science, 2051 Waukegan Road, Deerfield, IL 60015, 312-948-8600, or equivalent.

[Note: All such materials in contact with the sample, analyte, or support gases prior to analysis should be stainless steel or other inert metal. Do not use plastic or Teflon® tubing or fittings.]

10. Preparation of PUF Sampling Cartridge

[Note: This method was developed using the PS-1 sample cartridge provider by General Metal Works, Village of Cleves, OH as a guideline. EPA has experience in use of this equipment during various field monitoring

programs over the last several years. Other manufacturers' equipment should work as well. However, modifications to these procedures may be necessary if another commercially available sampler is selected.]

10.1 Summary of Method

10.1.1 This part of Compendium Method TO-4A discusses pertinent information regarding the preparation and cleaning of the filter, adsorbent, and filter/adsorbent cartridge assembly. The separate batches of filters and adsorbents are extracted with the appropriate solvent.

10.1.2 At least one PUF cartridge assembly and one filter from each batch, or 10 percent of the batch, whichever is greater, should be tested and certified clean before the batch is considered for field use.

10.2 Preparation of Sampling Cartridge

10.2.1 Bake the Whatman QMA-4 quartz filters at 400°C for 5 hours before use.

10.2.2 Set aside the filters in a clean container for shipment to the field or prior to combining with the PUF glass cartridge assembly for certification prior to field deployment.

10.2.3 The PUF plugs are 6.0-cm diameter cylindrical plugs cut from 3-inch sheet stock and should fit, with slight compression, in the glass cartridge, supported by the wire screen (see Figure 2). During cutting, rotate the die at high speed (e.g., in a drill press) and continuously lubricate with deionized or distilled water. Pre-cleaned PUF plugs can be obtained from many of the commercial sources identified in Section 9.1.2.

10.2.4 For initial cleanup, place the PUF plugs in a Soxhlet apparatus and extract with acetone for 16 hours at approximately 4 cycles per hour. When cartridges are reused, use diethyl ether/hexane (10 percent volume/volume [v/v]) as the cleanup solvent.

[Note: A modified PUF cleanup procedure can be used to remove unknown interference components of the PUF blank. This method consists of rinsing 50 times with toluene, acetone, and diethyl ether/hexane (5 to 10 percent v/v), followed by Soxhlet extraction. The extracted PUF is placed in a vacuum oven connected to a water aspirator and dried at room temperature for approximately 2 to 4 hours (until no solvent odor is detected). Alternatively, they may be dried at room temperature in an air-tight container with circulating nitrogen (zero grade). Place the clean PUF plug into a labeled glass sampling cartridge using gloves and forceps. Wrap the cartridge with hexane-rinsed aluminum foil and placed in a jar fitted with TFE fluorocarbon-lined caps. The foil wrapping may also be marked for identification using a blunt probe. The extract from the Soxhlet extraction procedure from each batch may be analyzed to determine initial cleanliness prior to certification.]

10.2.5 Fit a nickel or stainless steel screen (mesh size 200/200) to the bottom of a hexane-rinsed glass sampling cartridge to retain the PUF adsorbents, as illustrated in Figure 2. Place the Soxhlet-extracted, vacuum-dried PUF (2.5-cm thick by 6.5-cm diameter) on top of the screen in the glass sampling cartridge using polyester gloves.

10.2.6 Wrap the sampling cartridge with hexane-rinsed aluminum foil, cap with the Teflon® end caps, place in a cleaned labeled aluminum shipping container, and seal with Teflon® tape. Analyze at least 1 PUF plug from each batch of PUF plugs using the procedure described in Section 10.3, before the batch is considered acceptable for field use. A blank level of <10 ng/plug and filter for single component compounds is considered to be acceptable. For multiple component mixtures (e.g., PCBs), the blank level should be <100 ng/plug and filter. Cartridges are considered clean for up to 30 days from date of certification when stored in their sealed containers.

10.3 Procedure for Certification of PUF Cartridge Assembly

10.3.1 Extract 1 filter and PUF adsorbent cartridge by Soxhlet extraction and concentrate using a Kuderna-Danish (K-D) evaporator for each lot of filters and cartridges sent to the field.

10.3.2 Assemble the Soxhlet apparatus. Charge the Soxhlet apparatus (see Figure 4a) with 300 mL of the extraction solvent [10 percent (v/v) diethyl ether/hexane] and reflux for 2 hours. Let the apparatus cool, disassemble it, and discard the used extraction solvent. Transfer the filter and PUF glass cartridge to the Soxhlet apparatus (the use of an extraction thimble is optional).

[Note: The filter and adsorbent assembly are extracted together in order to reach detection limits, to minimize cost and to prevent misinterpretation of the data. Separate analyses of the filter and PUF would not yield useful information about the physical state of most of the common pesticides and PCBs at the time of sampling due to evaporative losses of the analyte from the filter during sampling.]

10.3.3 Add between 300 and 350 mL of diethyl ether/hexane (10 percent v/v) to the Soxhlet apparatus. Reflux the sample for 18 hours at a rate of at least 3 cycles per hour. Allow to cool, then disassemble the apparatus.

10.3.4 Assemble a K-D concentrator (see Figure 4b) by attaching a 10-mL concentrator tube to a 500-mL evaporative flask.

10.3.5 Transfer the extract by pouring it through a drying column containing about 10 cm of anhydrous granular sodium sulfate (see Figure 4c) and collect the extract in the K-D concentrator. Rinse the Erlenmeyer flask and column with 20 to 30 mL of 10 percent diethyl ether/hexane to complete the quantitative transfer.

10.3.6 Add 1 or 2 clean boiling chips and attach a 3-ball Snyder column to the evaporative flask. Pre-wet the Snyder column by adding about 1 mL of the extraction solvent to the top of the column. Place the K-D apparatus on a hot water bath (50°C) so that the concentrator tube is partially immersed in the hot water, and the entire lower rounded surface of the flask is bathed with hot vapor. Adjust the vertical position of the apparatus and the water temperature as required to complete the concentration in one hour. At the proper rate of distillation, the balls of the column will actively chatter but the chambers will not flood with condensed solvent. When the apparent volume of liquid reaches approximately 5 mL, remove the K-D apparatus from the water bath and allow it to drain and cool for at least 5 minutes. Remove the Snyder column and rinse the flask and its lower joint into the concentrator tube with 5 mL of hexane. A 5-mL syringe is recommended for this operation.

[Note: The solvent may have to be exchanged to another solvent to meet the requirements of the analytical procedure selected for the target analytes.]

10.3.7 Concentrate the extract to 1 mL and analyze according to Section 13.

10.3.8 Acceptable levels of common pesticides must be less than 10 ng for each pair of filter and adsorbent assembly analyzed. For multiple component mixtures (e.g., PCBs), the blank level should be less than 100 ng for each pair of filter and adsorbent. Once certified clean, the cartridges can be shipped to the field without being chilled.

11. Assembly, Calibration and Collection Using High-Volume Sampling System

[Note: This method was developed using the PS-1 semi-volatile sampler provided by General Metal Works, Village of Cleves, OH as a guideline. EPA has experience in use of this equipment during various field monitoring programs over the last several years. Other manufacturers' equipment should work as well.]

However, modifications to these procedures may be necessary if another commercially available sampler is selected.]

11.1 Description of Sampling Apparatus

The entire sampling system is diagrammed in Figure 1. This apparatus was developed to operate at a rate of 4 to 10 scfm (0.114 to 0.285 std m³/min) and is used by EPA for high-volume sampling of ambient air. The method write-up presents the use of this device.

The sampling module (see Figure 2) consists of a filter and a glass sampling cartridge containing the PUF utilized to concentrate common pesticides and PCBs from the air. A field portable unit has been developed by EPA (see Figure 3).

11.2 Calibration of Sampling System

Each sampler should be calibrated (1) when new, (2) after major repairs or maintenance, (3) whenever any audit point deviates from the calibration curve by more than 7 percent, (4) before/after each sampling event, and (5) when a different sample collection media, other than that which the sampler was originally calibrated to, will be used for sampling.

11.2.1 Calibration of Orifice Transfer Standard. Calibrate the modified high volume air sampler in the field using a calibrated orifice flow rate transfer standard. Certify the orifice transfer standard in the laboratory against a positive displacement rootsmeter (see Figure 6). Once certified, the recertification is performed rather infrequently if the orifice is protected from damage. Recertify the orifice transfer standard performed once per year utilizing a set of five multiple resistance plates.

[Note: The set of five multihole resistance plates are used to change the flow through the orifice so that several points can be obtained for the orifice calibration curve. The following procedure outlines the steps to calibrate the orifice transfer standard in the laboratory.]

11.2.1.1 Record the room temperature (T_1 in °C) and barometric pressure (P_b in mm Hg) on the Orifice Calibration Data Sheet (see Figure 7). Calculate the room temperature in K (absolute temperature) and record on Orifice Calibration Data Sheet.

$$T_1 \text{ in K} = 273^\circ + T_1 \text{ in } ^\circ\text{C}$$

11.2.1.2 Set up laboratory orifice calibration equipment as illustrated in Figure 6. Check the oil level of the rootsmeter prior to starting. There are 3 oil level indicators, 1 at the clear plastic end and 2 site glasses, 1 at each end of the measuring chamber.

11.2.1.3 Check for leaks by clamping both manometer lines, blocking the orifice with cellophane tape, turning on the high volume motor, and noting any change in the rootsmeter's reading. If the rootsmeter's reading changes, there is a leak in the system. Eliminate the leak before proceeding. If the rootsmeter's reading remains constant, turn off the hi-vol motor, remove the cellophane tape, and unclamp both manometer lines.

11.2.1.4 Install the 5-hole resistance plate between the orifice and the filter adapter.

11.2.1.5 Turn manometer tubing connectors 1 turn counter-clockwise. Make sure all connectors are open.

11.2.1.6 Adjust both manometer midpoints by sliding their movable scales until the zero point corresponds with the meniscus. Gently shake or tap to remove any air bubbles and/or liquid remaining on tubing connectors. (If additional liquid is required for the water manometer, remove tubing connector and add clean water.)

11.2.1.7 Turn on the high volume motor and let it run for 5 minutes to set the motor brushes. Turn the motor off. Insure manometers are set to zero. Turn the high volume motor on.

11.2.1.8 Record the time, in minutes, required to pass a known volume of air (approximately 200 to 300 ft³ of air for each resistance plate) through the rootsmeter by using the rootsmeter's digital volume dial and a stopwatch.

11.2.1.9 Record both manometer readings-orifice water manometer (ΔH) and rootsmeter mercury manometer (ΔP) on Orifice Calibration Data Sheet (see Figure 7).

[Note: ΔH is the sum of the difference from zero (0) of the two column heights.]

11.2.1.10 Turn off the high volume motor.

11.2.1.11 Replace the 5-hole resistance plate with the 7-hole resistance plate.

11.2.1.12 Repeat Sections 11.2.1.3 through 11.2.1.11.

11.2.1.13 Repeat for each resistance plate. Note results on Orifice Calibration Data Sheet (see Figure 7). Only a minute is needed for warm-up of the motor. Be sure to tighten the orifice enough to eliminate any leaks. Also check the gaskets for cracks.

[Note: The placement of the orifice prior to the rootsmeter causes the pressure at the inlet of the rootsmeter to be reduced below atmospheric conditions, thus causing the measured volume to be incorrect. The volume measured by the rootsmeter must be corrected.]

11.2.1.14 Correct the measured volumes on the Orifice Calibration Data Sheet:

$$V_{\text{std}} = V_{\text{m}} \left(\frac{P_{\text{a}} - \Delta P}{P_{\text{std}}} \right) \left(\frac{T_{\text{std}}}{T_{\text{a}}} \right)$$

where:

V_{std} = standard volume, std m³

V_{m} = actual volume measured by the rootsmeter, m³

P_{a} = barometric pressure during calibration, mm Hg

ΔP = differential pressure at inlet to volume meter, mm Hg

P_{std} = 760 mm Hg

T_{std} = 273 + 25 °C = 298 K

T_{a} = ambient temperature during calibration, K.

11.2.1.15 Record standard volume on Orifice Calibration Data Sheet.

11.2.1.16 The standard flow rate as measured by the rootsmeter can now be calculated using the following formula:

$$Q_{\text{std}} = \frac{V_{\text{std}}}{\theta}$$

where:

Q_{std} = standard volumetric flow rate, std m³/min

θ = elapsed time, min

11.2.1.17 Record the standard flow rates to the nearest 0.01 std m³/min.

11.2.1.18 Calculate and record $\sqrt{\Delta H (P_1/P_{std})(298/T_1)}$ value for each standard flow rate.

11.2.1.19 Plot each $\sqrt{\Delta H (P_1/P_{std})(298/T_1)}$ value (y-axis) versus its associated standard flow rate (x-axis) on arithmetic graph paper and draw a line of best fit between the individual plotted points.

[*Note: This graph will be used in the field to determine standard flow rate.*]

11.2.2 Calibration of the High Volume Sampling System Utilizing Calibrated Orifice Transfer Standard

For this calibration procedure, the following conditions are assumed in the field:

- The sampler is equipped with a valve to control sample flow rate.
- The sample flow rate is determined by measuring the orifice pressure differential, using a Magnehelic gauge.
- The sampler is designed to operate at a standardized volumetric flow rate of 8 ft³/min (0.225 m³/min), with an acceptable flow rate range within 10 percent of this value.
- The transfer standard for the flow rate calibration is an orifice device. The flow rate through the orifice is determined by the pressure drop caused by the orifice and is measured using a "U" tube water manometer or equivalent.
- The sampler and the orifice transfer standard are calibrated to standard volumetric flow rate units (scfm or scmm).
- An orifice transfer standard with calibration traceable to NIST is used.
- A "U" tube water manometer or equivalent, with a 0- to 16-inch range and a maximum scale division of 0.1 inch, will be used to measure the pressure in the orifice transfer standard.
- A Magnehelic gauge or equivalent, with a 9- to 100-inch range and a minimum scale division of 2 inches for measurements of the differential pressure across the sampler's orifice is used.
- A thermometer capable of measuring temperature over the range of 32° to 122°F (0° to 50°C) to ±2°F (±1°C) and referenced annually to a calibrated mercury thermometer is used.
- A portable aneroid barometer (or equivalent) capable of measuring ambient barometric pressure between 500 and 800 mm Hg (19.5 and 31.5 in. Hg) to the nearest mm Hg and referenced annually to a barometer of known accuracy is used.
- Miscellaneous handtools, calibration data sheets or station log book, and wide duct tape are available.

11.2.2.1 Set up the calibration system as illustrated in Figure 8. Monitor the airflow through the sampling system with a venturi/Magnehelic assembly, as illustrated in Figure 8. Audit the field sampling system once per quarter using a flow rate transfer standard, as described in the EPA *High Volume-Sampling Method, 40 CFR 50, Appendix B*. Perform a single-point calibration before and after each sample collection, using the procedures described in Section 11.2.3.

11.2.2.2 Prior to initial multi-point calibration, place an empty glass cartridge in the sampling head and activate the sampling motor. Fully open the flow control valve and adjust the voltage variator so that a sample flow rate corresponding to 110 percent of the desired flow rate (typically 0.20 to 0.28 m³/min) is indicated on the Magnehelic gauge (based on the previously obtained multipoint calibration curve). Allow the motor to warm up for 10 minutes and then adjust the flow control valve to achieve the desired flow rate. Turn off the sampler. Record the ambient temperature and barometric pressure on the Field Calibration Data Sheet (see Figure 9).

11.2.2.3 Place the orifice transfer standard on the sampling head and attach a manometer to the tap on the transfer standard, as illustrated in Figure 8. Properly align the retaining rings with the filter holder and secure

by tightening the three screw clamps. Connect the orifice transfer standard by way of the pressure tap to a manometer using a length of tubing. Set the zero level of the manometer or Magnehelic. Attach the Magnehelic gauge to the sampler venturi quick release connections. Adjust the zero (if needed) using the zero adjust screw on face of the gauge.

11.2.2.4 To leak test, block the orifice with a rubber stopper, wide duct tape, or other suitable means. Seal the pressure port with a rubber cap or similar device. Turn on the sampler.

Caution: Avoid running the sampler for too long a time with the orifice blocked. This precaution will reduce the chance that the motor will be overheated due to the lack of cooling air. Such overheating can shorten the life of the motor.

11.2.2.5 Gently rock the orifice transfer standard and listen for a whistling sound that would indicate a leak in the system. A leak-free system will not produce an upscale response on the sampler's Magnehelic. Leaks are usually caused either by damaged or missing gaskets by cross-threading and/or not screwing sample cartridge together tightly. All leaks must be eliminated before proceeding with the calibration. When the sample is determined to be leak-free, turn off the sampler and unblock the orifice. Now remove the rubber stopper or plug from the calibrator orifice.

11.2.2.6 Turn the flow control valve to the fully open position and turn the sampler on. Adjust the flow control valve until a Magnehelic reading of approximately 70 in. is obtained. Allow the Magnehelic and manometer readings to stabilize and record these values on the orifice transfer Field Calibration Data Sheet (see Figure 9).

11.2.2.7 Record the manometer reading under Y1 and the Magnehelic reading under Y2 on the Field Calibration Data Sheet. For the first reading, the Magnehelic should still be at 70 inches as set above.

11.2.2.8 Set the Magnehelic to 60 inches by using the sampler's flow control valve. Record the manometer (Y1) and Magnehelic (Y2) readings on the Field Calibration Data Sheet (see Figure 9).

11.2.2.9 Repeat the above steps using Magnehelic settings of 50, 40, 30, 20, and 10 inches.

11.2.2.10 Turn the voltage variator to maximum power, open the flow control valve, and confirm that the Magnehelic reads at least 100 inches. Turn off the sampler and confirm that the Magnehelic reads zero.

11.2.2.11 Read and record the following parameters on the Field Calibration Data Sheet. Record the following on the calibration data sheet:

Data, job number, and operator's signature;

- Sampler serial number;
- Ambient barometric pressure; and
- Ambient temperature.

11.2.2.12 Remove the "dummy" cartridge and replace with a sample cartridge.

11.2.2.13 Obtain the Manufacturer High Volume Orifice Calibration Certificate.

11.2.2.14 If not performed by the manufacturer, calculate values for each calibrator orifice static pressure (Column 6, inches of water) on the manufacturer's calibration certificate using the following equation:

$$\sqrt{\Delta H(P_a/760)(298/[T_a + 273])}$$

where:

P_a = the barometric pressure (mm Hg) at time of manufacturer calibration, mm Hg

T_a = temperature at time of calibration, °C

11.2.2.15 Perform a linear regression analysis using the values in Column 7 of the manufacturer High Volume Orifice Calibration Certificate for flow rate (Q_{std}) as the "X" values and the calculated values as the Y

values. From this relationship, determine the correlation (CC1), intercept (B1), and slope (M1) for the Orifice Transfer Standard.

11.2.2.16 Record these values on the Field Calibration Data Sheet (see Figure 9).

11.2.2.17 Using the Field Calibration Data Sheet values (see Figure 9), calculate the Orifice Manometer Calculated Values (Y3) for each orifice manometer reading using the following equation:

Y3 Calculation

$$Y3 = [Y1(P_a/760)(298/(T_a + 273))]^{1/2}$$

11.2.2.18 Record the values obtained in Column Y3 on the Field Calibration Data Sheet (see Figure 9).

11.2.2.19 Calculate the Sampler Magnehelic Calculate Values (Y4) using the following equation:

Y4 Calculation

$$Y4 = [Y2(P_a/760)(298/(T_a + 273))]^{1/2}$$

11.2.2.20 Record the value obtained in Column Y4 on the Field Calibration Data Sheet (see Figure 9).

11.2.2.21 Calculate the Orifice Flow Rate (X1) in scm, using the following equation:

X1 Calculation

$$X1 = \frac{Y3 - B1}{M1}$$

11.2.2.22 Record the values obtained in Column X1, on the Field Calibration Data Sheet (see Figure 9).

11.2.2.23 Perform a linear regression of the values in Column X1 (as X) and the values in Column Y4 (as Y). Record the relationship for correlation (CC2), intercept (B2), and slope (M2) on the Field Calibration Data Sheet.

11.2.2.24 Using the following equation, calculate a set point (SP) for the manometer to represent a desired flow rate:

$$\text{Set point (SP)} = [(Expected P_a)/(Expected T_a)(T_{std}/P_{std})][M2 (\text{Desired flow rate}) + B2]^2$$

where:

P_a = Expected atmospheric pressure (P_a), mm Hg

T_a = Expected atmospheric temperature (T_a), °C

M2 = Slope of developed relationship

B2 = Intercept of developed relationship

T_{std} = Temperature standard, 25°C

P_{std} = Pressure standard, 760 mm Hg

11.2.2.25 During monitoring, calculate a flow rate from the observed Magnehelic reading using the following equations:

$$Y5 = [\text{Average Magnehelic Reading } (\Delta H) (P_a/T_a)(T_{std}/P_{std})]^{1/2}$$

$$X2 = \frac{Y5 - B2}{M2}$$

where:

Y5 = Corrected Magnehelic reading

X2 = Instant calculated flow rate, scfm

11.2.2.26 The relationship in calibration of a sampling system between Orifice Transfer Standard and flow rate through the sampler is illustrated in Figure 10.

11.2.3 Single-Point Audit of the High Volume Sampling System Utilizing Calibrated Orifice Transfer Standard

Single point calibration checks are required as follows:

- Prior to the start of each 24-hour test period.
- After each 24-hour test period. The post-test calibration check may serve as the pre-test calibration check for the next sampling period if the sampler is not moved.
- Prior to sampling after a sample is moved.

For samplers, perform a calibration check for the operational flow rate before each 24-hour sampling event and when required as outlined in the user quality assurance program. The purpose of this check is to track the sampler's calibration stability. Maintain a control chart presenting the percentage difference between a sampler's indicated and measured flow rates. This chart provides a quick reference of sampler flow-rate drift problems and is useful for tracking the performance of the sampler. Either the sampler log book or a data sheet will be used to document flowcheck information. This information includes, but is not limited to, sampler and orifice transfer standard serial number, ambient temperature, pressure conditions, and collected flow-check data.

In this subsection, the following is assumed:

- The flow rate through a sampler is indicated by the orifice differential pressure;
- Samplers are designed to operate at an actual flow rate of 8 scfm, with a maximum acceptable flow-rate fluctuation range of ± 10 percent of this value;
- The transfer standard will be an orifice device equipped with a pressure tap. The pressure is measured using a manometer; and
- The orifice transfer standard's calibration relationship is in terms of standard volumetric flow rate (Q_{std}).

11.2.3.1 Perform a single point flow audit check before and after each sampling period utilizing the Calibrated Orifice Transfer Standard (see Section 11.2.1).

11.2.3.2 Prior to single point audit, place a "dummy" glass cartridge in the sampling head and activate the sampling motor. Fully open the flow control valve and adjust the voltage variator so that a sample flow rate corresponding to 110 percent of the desired flow rate (typically 0.19 to 0.28 m³/min) is indicated on the Magnehelic gauge (based on the previously obtained multipoint calibration curve). Allow the motor to warm up for 10 minutes and then adjust the flow control valve to achieve the desired flow rate. Turn off the sampler. Record the ambient temperature and barometric pressure on the Field Test Data Sheet (see Figure 11).

11.2.3.3 Place the flow rate transfer standard on the sampling head.

11.2.3.4 Properly align the retaining rings with the filter holder and secure by tightening the 3 screw clamps. Connect the flow rate transfer standard to the manometer using a length of tubing.

11.2.3.5 Using tubing, attach 1 manometer connector to the pressure tap of the transfer standard. Leave the other connector open to the atmosphere.

11.2.3.6 Adjust the manometer midpoint by sliding the movable scale until the zero point corresponds with the water meniscus. Gently shake or tap to remove any air bubbles and/or liquid remaining on tubing connectors. (If additional liquid is required, remove tubing connector and add clean water.)

11.2.3.7 Turn on high-volume motor and let run for 5 minutes.

11.2.3.8 Record the pressure differential indicated, ΔH , in inches of water, on the Field Test Data Sheet. Be sure stable ΔH has been established.

11.2.3.9 Record the observed Magnahelic gauge reading, in inches of water, on the Field Test Data Sheet. Be sure stable ΔM has been established.

11.2.3.10 Using previous established Orifice Transfer Standard curve, calculate Q_{xs} (see Section 11.2.2.23).

11.2.3.11 This flow should be within ± 10 percent of the sampler set point, normally, 8 ft³. If not, perform a new multipoint calibration of the sampler.

11.2.3.12 Remove flow rate transfer standard and dummy adsorbent cartridge.

11.3 Sample Collection

11.3.1 General Requirements

11.3.1.1 The sampler should be located in an unobstructed area, at least 2 meters from any obstacle to air flow. The exhaust hose should be stretched out in the downwind direction to prevent recycling of air into the sample head.

11.3.1.2 All cleaning and sample module loading and unloading should be conducted in a controlled environment, to minimize any chance of potential contamination.

11.3.1.3 When new or when using the sampler at a different location, all sample contact areas need to be cleared. Use triple rinses of reagent grade hexane contained in Teflon® rinse bottles. Allow the solvent to evaporate before loading the PUF modules.

11.3.2 Preparing Cartridge for Sampling

11.3.2.1 Detach the lower chamber of the cleaned sample head. While wearing disposable, clean, lint-free nylon, or powder-free surgical gloves, remove a clean glass adsorbent module from its shipping container. Remove the Teflon® end caps. Replace the end caps in the sample container to be reused after the sample has been collected.

11.3.2.2 Insert the glass module into the lower chamber and tightly reattach the lower chambers to the module.

11.3.2.3 Using clean rinsed (with hexane) Teflon-tipped forceps, carefully place a clean conditioned fiber filter atop the filter holder and secure in place by clamping the filter holder ring over the filter. Place the aluminum protective cover on top of the cartridge head. Tighten the 3 screw clamps. Ensure that all module connections are tightly assembled. Place a small piece of aluminum foil on the ball-joint of the sample cartridge to protect from back-diffusion of semi-volatile into the cartridge during transporting to the site.

[Note: Failure to do so could result in air flow leaks at poorly sealed locations which could affect sample representativeness.]

11.3.2.4 Place in a carrying bag to take to the sampler.

11.3.3 Collection

11.3.3.1 After the sampling system has been assembled, perform a single point flow check as described in Sections 11.2.3.

11.3.3.2 With the empty sample module removed from the sampler, rinse all sample contact areas using reagent grade hexane in a Teflon® squeeze bottle. Allow the hexane to evaporate from the module before loading the samples.

11.3.3.3 With the sample cartridge removed from the sampler and the flow control valve fully open, turn the pump on and allow it to warm-up for approximately 5 minutes.

11.3.3.4 Attach a "dummy" sampling cartridge loaded with the exact same type of filter and PUF media to be used for sample collection.

11.3.3.5 Turn the sampler on and adjust the flow control valve to the desired flow as indicated by the Magnehelic gauge reading determined in Section 11.2.2.24. Once the flow is properly adjusted, take extreme care not to inadvertently alter its setting.

11.3.3.6 Turn the sampler off and remove the "dummy" module. The sampler is now ready for field use.

11.3.3.7 Check the zero reading of the sampler Magnehelic. Record the ambient temperature, barometric pressure, elapsed time meter setting, sampler serial number, filter number, and PUF cartridge number on the Field Test Data Sheet (see Figure 11). Attach the loaded sampler cartridge to the sampler.

11.3.3.8 Place the voltage variator and flow control valve at the settings used in Section 11.3.2, and the power switch. Activate the elapsed time meter and record the start time. Adjust the flow (Magnehelic setting), if necessary, using the flow control valve.

11.3.3.9 Record the Magnehelic reading every 6 hours during the sampling period. Use the calibration factors (see Section 11.2.2.24) to calculate the desired flow rate. Record the ambient temperature, barometric pressure, and Magnehelic reading at the beginning and during sampling period.

11.3.4 Sample Recovery

11.3.4.1 At the end of the desired sampling period, turn the power off. Carefully remove the sampling head containing the filter and adsorbent cartridge. Place the protective "plate" over the filter to protect cartridge during transport to clean recovery area. Also, place a piece of aluminum foil around the bottom of adsorbent sampler head.

11.3.4.2 Perform a final calculated sampler flow check using the calibration orifice, as described in Section 11.3.2. If calibration deviates by more than 10 percent from initial reading, mark the flow data for that sample as suspect and inspect and/or remove from service, record results on Field Test Data Sheet, Figure 11.

11.3.4.3 Transport adsorbent sampler head to a clean recovery area.

11.3.4.4 While wearing disposable lint free nylon or powder-free surgical gloves, remove the PUF cartridge from the lower module chamber and lay it on the retained aluminum foil in which the sample was originally wrapped.

11.3.4.5 Carefully remove the glass fiber filter from the upper chamber using clean Teflon®-tipped forceps.

11.3.4.6 Fold the filter in half twice (sample side inward) and place it in the glass cartridge atop the PUF.

11.3.4.7 Wrap the combined samples in the original hexane rinsed aluminum foil, attached Teflon® end caps and place them in their *original* aluminum sample container. Complete a sample label and affix it to the aluminum shipping container.

11.3.4.8 Chain-of-custody should be maintained for all samples. Store the containers under dry ice and protect from UV light to prevent possibly photo-decomposition of collected analytes. If the time span between sample collection and laboratory analysis is to exceed 24 hours, refrigerate sample at 4°C.

11.3.4.9 Return at least 1 field filter/PUF blank to the laboratory with each group of samples. Treat a field blank exactly as the sample except that no air is drawn through the filter/adsorbent cartridge assembly.

11.3.4.10 Ship and store field samples chilled ($<4^{\circ}$) (blue ice is acceptable) until receipt at the analytical laboratory, after which they should be refrigerated at less than or equal to 4°C . Extraction must be performed within 7 days of sampling and analysis within 40 days of extraction.

12. Sample Extraction Procedure

[Note: Sample extraction should be performed under a properly ventilated hood.]

12.1 Sample Extraction

12.1.1 All samples should be extracted within 1 week after collection. All samples should be stored at $<4^{\circ}\text{C}$ until extracted.

12.1.2 All glassware should be washed with a suitable detergent; rinsed with deionized water, acetone, and hexane; rinsed again with deionized water; and fired in an oven (500°C).

12.1.3 Prepare a spiking solution for determination of extraction efficiency. The spiking solution should contain one or more surrogate compounds that have chemical structures and properties similar to those of the analytes of interest. Octachloronaphthalene (OCN) and dibutylchlorendate have been used as surrogates for determination of organochlorine pesticides by GC with an ECD. Tetrachloro-m-xylene and decachlorobiphenyl can also be used together to insure recovery of early and late eluting compounds. For organophosphate pesticides, tributylphosphate or triphenylphosphate may be employed as surrogates. The surrogate solution should be prepared so that addition of $100\ \mu\text{L}$ into the PUF plug results in an extract containing the surrogate compound at the high end of the instrument's calibration range. As an example, the spiking solution for OCN is prepared by dissolving 10 mg of OCN in 10 mL of 10% acetone in n-hexane, followed by serial dilution n-hexane to achieve a final spiking solution of OCN is $1\ \mu\text{g}/\text{mL}$.

[Note: Use the recoveries of the surrogate compounds to monitor for unusual matrix effects and gross sample processing errors. Evaluate surrogate recovery for acceptance by determining whether the measured concentration falls within the acceptance limits of 60-120 percent.]

12.1.4 The extracting solution (10% diethyl ether/hexane) is prepared by mixing 1800 mL of freshly opened hexane and 200 mL of freshly opened diethyl ether (preserved with ethanol) to a flask.

12.1.5 All clean glassware, forceps, and other equipment to be used should be rinsed with 10% diethyl ether/hexane and placed on rinsed (10% diethyl ether/hexane) aluminum foil until use. The condensing towers should also be rinsed with 10% diethyl ether/hexane. Then add 700 mL of 10% diethyl ether/hexane to the 1,000 mL round bottom flask and add up to three boiling granules.

12.1.6 Using precleaned (i.e., 10% diethyl ether/hexane Soxhlet extracted) cotton gloves, the filter/PUF cartridge is removed from the sealed container, the PUF removed from the glass cartridge, and the filter/PUF together are placed into the 300 mL Soxhlet extractor using prerinsed forceps.

12.1.7 Before extraction begins, add $100\ \mu\text{L}$ of the OCN solution directly to the top of the PUF plug.

[Note: Incorporating a known concentration of the solution onto the sample provides a quality assurance check to determine recovery efficiency of the extraction and analytical processes.]

12.1.8 Connect the Soxhlet extractor to the 1,000 mL boiling flask and condenser. Wet the glass joints with 10% diethyl ether/hexane to ensure a tight seal between the fittings. If necessary, the PUF plug can be adjusted

using forceps to wedge it midway along the length of the siphon. The above procedure should be followed for all samples, with the inclusion of a blank control sample.

12.1.9 The water flow to the condenser towers of the Soxhlet extraction assembly should be checked and the heating unit turned on. As the samples boil, the Soxhlet extractors should be inspected to ensure that they are filling and siphoning properly (4 to 6 cycles/hour). Samples should cycle for a minimum of 16 hours.

12.1.10 At the end of the extracting process (minimum of 16 hours), the heating unit is turned off and the sample cooled to room temperature.

12.1.11 The extracts are then concentrated to 5 mL using a Kuderna-Danish (K-D) apparatus. The K-D is set up, assembled with concentrator tubes, and rinsed. The lower end of the filter tube is packed with glass wool and filled with sodium sulfate to a depth of 40 mm. The filter tube is then placed in the neck of the K-D. The Soxhlet extractors and boiling flasks are carefully removed from the condenser towers and the remaining solvent is drained into each boiling flask. Sample extract is carefully poured through the filter tube into the K-D. Each boiling flask is rinsed three times by swirling hexane along the sides. Once the sample has drained, the filter tube is rinsed down with hexane. Each Snyder column is attached to the K-D and rinsed to wet the joint for a tight seal. The complete K-D apparatus is placed on a steam bath and the sample is evaporated to approximately 5 mL.

[Note: Do not allow samples to evaporate to dryness.]

Remove sample from the steam bath, rinse the Snyder column with a minimum of hexane, and allow to cool. Adjust sample volume to 10 mL in a concentrator tube, close with a glass stopper, and seal with TFE fluorocarbon tape. Alternatively, the sample may be quantitatively transferred (with concentrator tube rinsing) to prescored vials and brought up to final volume. Concentrated extracts are stored at $<4^{\circ}\text{C}$ until analyzed. Analysis should occur no later than 40 days after sample extraction.

12.2 Sample Cleanup

12.2.1 If only polar compounds are sought, an alumina cleanup procedure is appropriate. Before cleanup, the sample extract is carefully reduced to 1 mL using a gentle stream of clean nitrogen.

12.2.2 A glass chromatographic column (2-mm I.D. x 15-cm long) is packed with alumina (7), activity grade IV, and rinsed with approximately 20 mL of n-hexane. The concentrated sample extract is placed on the column and eluted with 10 mL of n-hexane at a rate of 0.5 mL/minute. The eluate volume is adjusted to exactly 10 mL and analyzed as per Section 13.

12.2.3 If both PCBs and common pesticides are sought, alternate cleanup procedures (8,9) may be required (i.e., silicic acid).

12.2.4 Finally, class separation and improved specificity can be achieved by column clean-up and separation on Florisil (9).

13. Analytical Procedure

13.1 Analysis of Organochlorine Pesticides by Capillary Gas Chromatography with Electron Capture Detector (GC/ECD)

[Note: Organochlorine pesticides, PCBs and many nonchlorinated pesticides are responsive to electron capture detection (see Table 1). Most of these compounds can be analyzed at concentration of 1 to 50 ng/mL by GC/ECD. The following procedure is appropriate. Sampling and analytical methods that have been used to determine pesticides and PCBs collected from air using a modification of this methodology have been published (14-22).]

13.1.1 Select GC column (e.g., 0.3-mm by 30-m DB-5 column) and appropriate GC conditions to separate the target analytes. Typical operating parameters for this column with splitless injection are: Carrier gas-chromatography grade helium at a flow rate of 1 to 2 mL/min and a column head pressure of 7 to 9 psi (48 to 60 kPa); injector temperature of 250°C; detector temperature of 350°C; initial oven temperature of 50°C held for 2.0 min., ramped at 15°C/min to 150°C for 8 min, ramped at 10°C/min to 295°C then held for 5 min; purge time of 1.0 min. A typical injection volume is 2 to 3 μ L.

13.1.2 Remove sample extract from refrigerator and allow to warm to room temperature.

13.1.3 Prepare standard solution from reference materials of known purity. Analytically pure standards of organochlorine pesticides and PCBs are available from several commercial sources.

13.1.4 Use the standard solutions of the various compounds of interest to determine relative retention times (RRTs) to an internal standard such as p,p'-DDE, aldrin or octachloronaphthalene. Use 1 to 3- μ L injections or other appropriate volumes.

13.1.5 Determine detector linearity by injecting standard solutions of three different concentrations (amounts) that bracket the range of analyses. The calibration is considered linear if the relative standard deviation (RSD) of the three response factors for the three standards is 20 percent or less.

13.1.6 Calibrate the system with a minimum of three levels of calibration standards in the linear range. The low standard should be near the analytical method detection limit. The calibration is considered linear if the relative standard deviation (RSD) of the three response factors for the three standards is 20 percent or less. The initial calibration should be verified by the analysis of a standard from an independent source. Recovery of 85 to 115 percent is acceptable. The initial calibration curve should be verified at the beginning of each day and after every ten samples by the analysis of the midpoint standard; an RPD of 15% or less is acceptable for continuing use of the initial calibration curve.

13.1.7 Inject 1 to 3 μ L of sample extract. Record volume injected to the nearest 0.05 μ L.

13.1.8 A typical ECD response for a mixture of single component pesticides using a capillary column is illustrated in Figure 12. If the response (peak height or area) exceeds the calibration range, dilute the extract and reanalyze.

13.1.9 Quantify PCB mixtures by comparison of the total heights or areas of GC peaks (minimum of five) with the corresponding peaks in the best-matching standard. Use Aroclor 1242 for early-eluting PCBs and either Aroclor 1254 or Aroclor 1260 as appropriate for late-eluting PCBs.

13.1.10 If both PCBs and organochlorine pesticides are present in the same sample, use column chromatographic separation on silicic acid (8,9) prior to GC analysis.

13.1.11 If polar compounds are present that interfere with GC/ECD analysis, use column chromatographic cleanup or alumina (7), activity grade IV, in accordance with Section 12.2.

13.1.12 For confirmation use a second GC column such as DB-608. All GC procedures except GC/MS require second column confirmation.

13.1.13 For improved resolution use a capillary column such as an 0.25-mm I.D. x 30-m DB-5 with 0.25 μm film thickness. The following conditions are appropriate.

- Helium carrier gas at 1 mL/min.
- Column temperature program, 90°C (4 min)/16°C/min to 154°C/4°C/min to 270°C.
- Detector, ^{63}Ni ECD at 350°C.
- Make up gas, nitrogen, or 5% methane/95% argon at 60 mL/min.
- Splitless injection, 2 μL maximum.
- Injector temperature, 220°C.

13.1.14 Class separation and improved specificity can be achieved by column chromatographic separation on Florisil (9).

13.1.15 A Hall electrolytic conductivity detector (HECD) operated in the reductive mode may be substituted for the ECD for improved specificity. Sensitivity, however, will be reduced by at least an order of magnitude.

13.2 Analysis of Organophosphorus Pesticides by Capillary Gas Chromatography with Flame Photometric or Nitrogen-Phosphorus Detectors (GC/FPD/NPD)

[Note: Organophosphorus pesticides are responsive to flame photometric and nitrogen-phosphorus (alkali flame ionization) detection. Most of these compounds can be analyzed at concentrations of 50 to 500 ng/mL using either of these detectors.]

13.2.1 Procedures given in Section 13.1.1 through 13.1.9 and Section 13.1.13 through 13.1.14 apply, except for the selection of surrogates.

13.2.2 Use tributylphosphate, triphenylphosphate, or other suitable compound(s) as surrogates to verify extraction efficiency and to determine RRTs.

13.3 Analysis of Carbamate and Urea Pesticides by Capillary Gas Chromatography with Nitrogen-Phosphorus Detector

13.3.1 Trazine, carbamate, and urea pesticides may be determined by capillary GC (DB-5, DB-17, or DB-1701 stationary phase) using nitrogen-phosphorus detection or MS-SIM with detection limits in the 0.05 to 0.2 $\mu\text{L}/\text{mL}$ range. Procedures given in Section 13.1.1 through 13.1.9 and Section 13.1.13 through 13.1.14 apply, except for the selection of surrogates, detector, and make up gas.

13.3.2 Thermal degradation may be minimized by reducing the injector temperature to 200°C. HPLC may also be used, but detection limits will be higher (1 to 5 $\mu\text{g}/\text{mL}$).

13.3.3 N-methyl carbamates may be determined using reverse-phase high performance liquid chromatography (HPLC) (C-18) (Section 13.4) and post-column derivization with o-phthaldehyde and fluorescence detection (EPA Method 531). Detection limits of 0.01 to 0.1 $\mu\text{g}/\text{mL}$ can be achieved.

13.4 Analysis of Carbamate, Urea, Pyrethroid, and Phenolic Pesticides by High Performance Liquid Chromatography (HPLC)

[Note: Many carbamate pesticides, urea pesticides, pyrethrins, phenols, and other polar pesticides may be analyzed by high HPLC with fixed or variable wavelength UV detection. Either reversed-phase or normal phase chromatography may be used. Detection limits are 0.2 to 10 µg/mL of extract.]

13.4.1 Select HPLC column (i.e., Zorbax-SIL, 46-mm I.D. x 25-cm, or µ-Bondapak C18, 3.9-mm x 30-cm, or equivalent).

13.4.2 Select solvent system (i.e., mixtures of methanol or acetonitrile with water or mixtures of heptane or hexane with isopropanol).

13.4.3 Follow analytical procedures given in Sections 13.1.2 through 13.1.9.

13.4.4 If interferences are present, adjust the HPLC solvent system composition or use column chromatographic clean-up with silica gel, alumina, or Florisil (9).

13.4.5 An electrochemical detector may be used to improve sensitivity for some ureas, carbonates, and phenolics. Much more care is required in using this detector, particularly in removing dissolved oxygen from the mobile phase and sample extracts.

13.4.6 Chlorophenol (di- through penta-) may be analyzed by GC/ECD or GC/MS after derivatization with pentafluorobenzylbromide (EPA Method 604).

13.4.7 Chlorinated phenoxyacetic acid herbicides and pentachlorophenol can be analyzed by GC/ECD or GC/MS after derivatization with diazomethane (EPA Method 515). DB-5 and DBJ-1701 columns (0.25-mm I.D. x 30-m) at 60 to 300°C/4°C per min have been found to perform well.

13.5 Analysis of Pesticides and PCBs by Gas Chromatography with Mass Spectrometry Detection (GC/MS)

[Note: A mass spectrometer operating in the selected ion monitoring mode is useful for confirmation and identification of pesticides.]

13.5.1 A mass spectrometer operating in select ion monitoring (SIM) mode can be used as a sensitive detector for multi-residue determination of a wide variety of pesticides. Mass spectrometers are now available that provide detection limits comparable to nitrogen-phosphorus and electron capture detectors.

13.5.2 Most of the pesticides shown in Table 1 have been successfully determined by GC/MS-SIM. Typical GC operating parameters are as described in Section 13.1.1.

13.5.3 The mass spectrometer is typically operated using positive ion electron impact ionization (70 eV). Other instrumental parameters are instrument specific.

13.5.4 p-Terphenyl-d₁₄ is commonly used as a surrogate for GC/MS analysis.

13.5.5 Quantification is typically performed using an internal standard method. 1,4-Dichlorobenzene, naphthalene-d₈, acenaphthene-d₁₀, phenanthrene-d₁₀, chrysene-d₁₂ and perylene-d₁₂ are commonly used as internal standards. Procedures given in Section 13.1.1 through 13.1.9 and Section 13.1.13 through 13.1.14 apply, except for the selection of surrogates, detector, and make up gas.

13.5.6 See ASTM Practice D 3687 for injection technique, determination of relative retention times, and other procedures pertinent to GC and HPLC analyses.

13.6 Sample Concentration

13.6.1 If concentrations are too low to detect by the analytical procedure of choice, the extract may be concentrated to 1 mL or 0.5 mL by carefully controlled evaporation under an inert atmosphere. The following procedure is appropriate.

13.6.2 Place K-D concentrator tube in a water bath and analytical evaporator (nitrogen blow-down) apparatus. The water bath temperature should be from 25°C to 50°C.

13.6.3 Adjust nitrogen flow through hypodermic needle to provide a gentle stream.

13.6.4 Carefully lower hypodermic needle into the concentrator tube to a distance of about 1 cm above the liquid level.

13.6.5 Continue to adjust needle placement as liquid level decreases.

13.6.6 Reduce volume to slightly below desired level.

13.6.7 Adjust to final volume by carefully rinsing needle tip and concentrator tube well with solvent (usually n-hexane).

14. Calculations

14.1 Determination of Concentration

14.1.1 The concentration of the analyte in the extract solution can be taken from a standard curve where peak height or area is plotted linearly against concentration in nanograms per milliliter (ng/mL). If the detector response is known to be linear, a single point is used as a calculation constant.

14.1.2 From the standard curve, determine the nanograms of analyte standard equivalent to the peak height or area for a particular compound.

14.1.3 Ascertain whether the field blank is contaminated. Blank levels should not exceed 10 ng/sample for organochlorine pesticides or 100 ng/sample for PCBs and other pesticides. If the blank has been contaminated, the sampling series must be held suspect.

14.2 Equations

14.2.1 Quantity of the compound in the sample (A) is calculated using the following equation:

$$A = 1000 \left(\frac{A_s \times V_e}{V_i} \right)$$

where:

A = total amount of analyte in the sample, ng.

A_s = calculated amount of material injected onto the chromatograph based on calibration curve for injected standards, ng.

V_e = final volume of extract, mL.

V_i = volume of extract injected, μL.

1000 = factor for converting microliters to milliliters.

14.2.2 The extraction efficiency (EE) is determined from the recovery of surrogate spike as follows:

$$EE(\%) = \left| \frac{S}{S_a} \right| [100]$$

where:

EE = extraction efficiency, %

S = amount of spike recovered, ng.

S_a = amount of spike added to plug, ng.

The extraction efficiency (surrogate recovery) must fall between 60-120% to be acceptable.

14.2.3 The total volume of air sampled under ambient conditions is determined using the following equation:

$$V_a = \frac{\sum_{i=1}^n (T_i \times F_i)}{1000 \text{ L/m}^3}$$

where:

V_a = total volume of air sampled, m³.

T_i = length of sampling segment between flow checks, min.

F_i = average flow during sampling segment, L/min.

14.2.4 The air volume is corrected to EPA standard temperature (25°C) and standard pressure (760 mm Hg) as follows:

$$V_s = V_a \left(\frac{P_b - P_w}{760 \text{ mm Hg}} \right) \left(\frac{298K}{t_A} \right)$$

where:

V_s = volume of air at standard conditions (25°C and 760 mm Hg), std. m³.

V_a = total volume of air sampled, m³.

P_b = average ambient barometric pressure, mm Hg.

P_w = vapor pressure of water at calibration temperature, mm Hg.

t_A = average ambient temperature, °C + 273.

14.2.5 If the proper criteria for a sample have been met, concentration of the compound in a standard cubic meter of air sampled is calculated as follows:

$$C_a(\text{ng/std. m}^3) = \left[\frac{(A)}{(V_s)} \right]$$

If it is desired to convert the air concentration value to parts per trillion (ppt) in dry air at standard temperature and pressure (STP), the following conversion is used:

$$\text{ppt} = 0.844 (C_a)$$

The air concentration can be converted to parts per trillion (v/v) in air at STP as follows:

$$\text{pptv} = \left[\frac{(24.45) (C_a)}{(\text{MW})} \right]$$

where:

MW = molecular weight of the compound of interest, g/g-mole.

14.2.6 If quantification is performed using an internal standard, a relative response factor (RRF) is calculated by the equation:

$$\text{RRF} = \left[\frac{(I_s)(C_{is})}{(I_{is})(C_s)} \right]$$

where:

I_s = integrated area of the target analyte peak, counts.

I_{is} = integrated area of the internal standard peak, counts.

C_{is} = concentration of the internal standard, ng/ μ L.

C_s = concentration of the analyte, ng/ μ L.

14.2.7 The concentration of the analyte (C_a) in the sample is then calculated as follows:

$$C_a = \frac{(I_s)(C_{is})}{(\text{RRF})(I_{is})}$$

where:

I_s = integrated area of the target analyte peak, counts.

RRF = relative response factor (see Section 14.2.7).

15. Performance Criteria and Quality Assurance

[Note: This section summarizes required quality assurance (QA) measures and provides guidance concerning performance criteria that should be achieved within each laboratory.]

15.1 Standard Operating Procedures (SOPs)

15.1.1 Users should generate SOPs describing the following activities accomplished in their laboratory: (1) assembly, calibration, and operation of the sampling system, with make and model of equipment used; (2) preparation, purification, storage, and handling of sampling cartridges, (3) assembly, calibration, and operation of the analytical system, with make and model of equipment used; and (4) all aspects of data recording and processing, including lists of computer hardware and software used.

15.1.2 SOPs should provide specific stepwise instructions and should be readily available to, and understood by, the laboratory personnel conducting the work.

15.2 Process, Field, and Solvent Blanks

15.2.1 One filter/PUF cartridge from each batch of approximately twenty should be analyzed, without shipment to the field, for the compounds of interest to serve as a process blank.

15.2.2 During each sampling episode, at least one filter/PUF cartridge should be shipped to the field and returned, without drawing air through the sampler, to serve as a field blank.

15.2.3 Before each sampling episode, one PUF plug from each batch of approximately twenty should be spiked with a known amount of the standard solution. The spiked plug will remain in a sealed container and will not be used during the sampling period. The spiked plug is extracted and analyzed with the other samples. This field spike acts as a quality assurance check to determine matrix spike recoveries and to indicate sample degradation.

15.2.4 During the analysis of each batch of samples, at least one solvent process blank (all steps conducted but no filter/PUF cartridge included) should be carried through the procedure and analyzed.

15.2.5 Levels for process, field and solvent blanks should not exceed 10 ng/sample for single components or 100 ng/sample for multiple component mixtures (i.e., for organochlorine pesticides and PCBs).

15.3 Method Precision and Bias

15.3.1 Precision and bias in this type of analytical procedure are dependent upon the precision and bias of the analytical procedure for each compound of concern, and the precision and bias of the sampling process.

15.3.2 Several different parameters involved in both the sampling and analysis steps of this method collectively determine the precision and bias with which each compound is detected. As the volume of air sampled is increased, the sensitivity of detection increases proportionately within limits set by: (a) the retention efficiency for each specific component trapped on the polyurethane foam plug, and (b) the background interference associated with the analysis of each specific component at a given site sampled. The sensitivity of detection of samples recovered by extraction depends on: (a) the inherent response of the particular GC detector used in the determinative step, and (b) the extent to which the sample is concentrated for analysis. It is the responsibility of the analyst(s) performing the sampling and analysis steps to adjust parameters so that the required detection limits can be obtained.

15.3.3 The reproducibility of this method for most compounds for which it has been evaluated has been determined to range from ± 5 to $\pm 30\%$ (measured as the relative standard deviation) when replicate sampling cartridges are used ($N > 5$). Sample recoveries for individual compounds generally fall within the range of 90 to 110%, but recoveries ranging from 65 to 125% are considered acceptable.

15.4 Method Safety

15.4.1 This procedure may involve hazardous materials, operations, and equipment. This method does not purport to address all of the safety problems associated with its use.

15.4.2 It is the users responsibility to consult and establish appropriate safety and health practices and determine the applicability of regulatory limitations prior to the implementation of this procedure. This should be part of the users SOP manual.

16. References

1. Riggin, R. M., *Compendium of Methods for the Determination of Toxic Organic Compounds in Ambient Air*, U. S. Environmental Protection Agency, Environmental Monitoring Systems Laboratory, Quality Assurance Division, Research Triangle Park, NC, EPA-600/4-84-041, April 1984.
2. Winberry, W. T. Jr., et al., "Determination of Benzo(a)Pyrene and Other Polynuclear Aromatic Hydrocarbons (PAHs) in Ambient Air Using Gas Chromatographic (GC) and High Performance Liquid Chromatographic (HPLC) Analysis: Method TO-13," in *Compendium of Methods for the Determination of Toxic Organic Compounds in Ambient Air, Second Supplement*, U. S. Environmental Protection Agency, Environmental Monitoring Systems Laboratory, Quality Assurance Division, Research Triangle Park, NC, EPA-600/4-89-018, March 1989.
3. Winberry, W. T. Jr., et al., "Determination of Organochlorine Pesticides in Indoor Air: Method IP-8," in *Compendium of Methods for the Determination of Air Pollutant in Indoor Air*, U. S. Environmental Protection Agency, Research Triangle Park, NC, EPA-600/4-90-010, May 1990.
4. "Standard Practice for Sampling and Analysis of Pesticides and Polychlorinated Biphenyls in Air," *Annual Book of ASTM Standards*, Method D4861-94, ASTM, Philadelphia, PA.
5. Lewis, R., and MacLeod, K., "Portable Sampler for Pesticides and Semi-Volatile Industrial Organic Chemicals in Air," *Anal. Chem.*, Vol. 54, 1982, pp. 310-315.
6. Winberry, W. T. Jr., et al., "Determination of Organochlorine Pesticides in Ambient Air Using Low Volume Polyurethane Foam (PUF) Sampling with Gas Chromatography/Electron Capture Detector (GC/ECD): Method TO-10, in *Compendium of Methods for the Determination of Toxic Organic Compounds in Ambient Air, Second Supplement*, U. S. Environmental Protection Agency, Research Triangle Park, NC, EPA-600/4-89-018, March 1989.
7. Lewis, R., and Brown, A., and Jackson, M., "Evaluation of Polyurethane Foam for Sampling of Pesticides, Polychlorinated Biphenyls and Polychlorinated Naphthalenes in Ambient Air," *Anal. Chem.*, Vol. 49, 1977, pp. 1668-1672.
8. Armour, J., and Burke, J., "Method for Separating Polychlorinated Biphenyls from DDT and Its Analogs," *Journal of the Association of Official Analytical Chemists*, Vol. 53, No. 4, 1970, pp. 761-768.

9. *Manual of Analytical Methods for the Analysis of Pesticides in Human and Environmental Samples*, U. S. Environmental Protection Agency, Research Triangle Park, NC, EPA-600/8-80-038, June 1980 (NTIS No. PB82-208752).
10. *Carcinogens - Working with Carcinogens*, Department of Health, Education, and Welfare, Public Health Service, Center for Disease Control, National Institute for Occupational Safety and Health, Publication No. 77-206, August 1977.
11. *OSHA Safety and Health Standards, General Industry*, (29CFR1910), Occupational Safety and Health Administration, OSHA, 2206, Revised, January 1976.
12. "Safety in Academic Chemistry Laboratories," American Chemical Society Publication, Committee on Chemical Safety, 3rd Edition, 1979.
13. Kogan, V., Kuhlman, M., Coutant, R., and Lewis, R., "Aerosol Filtration in Sorbent Beds," *Journal of the Air and Waste Management Association*, Vol. 43, 1993, pp. 1367-1373.
14. Lewis, R., and Lee, R., "Air Pollution from Pesticide Sources, Occurrences and Dispersion," in: *Air Pollution from Pesticides and Agricultural Processes*, Lee, R., Editor, CRC Press, Boca Raton, FL, 1976, pp. 51-94.
15. Lewis, R., "Problem Associated with Sampling for Semi-Volatile Organic Chemicals in Air," in *Proceedings of the 1986 EPA/APCA Symposium on Measurement of Toxic Air Pollutants*, Air and Waste Management Association, Pittsburgh, PA, 1986, pp. 134-145.
16. Camann, D., Harding, J., and Lewis, R., "Trapping of Particle-Associated Pesticides in Indoor Air by Polyurethane Foam and Evaporation of Soil Track-In as a Pesticide Source," in: *Indoor Air '90*, Vol. 2, Walkinshaw, D., Editor, Canada Mortgage and Housing Corp., Ottawa, 1990, pp. 621-626.
17. Marple, V., Rubow, K., Turner, W., and Spengler, J., "Low Flow Rate Sharp Cut Impactors for Indoor Air Sampling Design and Calibration," *Journal of the Air Pollution Control Association*. Vol. 37, 1987, pp. 1303-1307.
18. Hsu, J., Wheeler, H., Camann, D., Shatterberg, H., Lewis, R., and Bond, A., "Analytical Methods for Detection of Non-Occupational Exposure to Pesticides," *Journal of Chromatographic Science*, Vol. 26, 1988, pp. 181-189.
19. Lewis, R. G., and Jackson, M. D., "Modification and Evaluation of a High-Volume Air Sampler for Pesticides and Semi-Volatile Industrial Organic Chemicals," *Anal. Chem.*, 54, 592-594, 1982.
20. Lewis, R. G., Jackson, M. D., and MacLeod, K. E., "Protocol for Assessment of Human Exposure to Airborne Pesticides," U. S. Environmental Protection Agency, Research Triangle Park, NC, EPA-600/2-80-180, May 1980.
21. Riggin, R. M., *Technical Assistance Document for Sampling and Analysis of Toxic Organic Compounds in Ambient Air*, U. S. Environmental Protection Agency, Research Triangle Park, NC, EPA-600/4-83-027, June 1983.

22. Longbottom, J. E., and Lichtenberg, J. J., "Methods for Organic Chemical Analysis of Municipal and Industrial Wastewater," U. S. Environmental Protection Agency, Cincinnati, OH, EPA-600/4-82-057, May 1982.

TABLE 1. COMPOUNDS FOR WHICH PROCEDURE HAS BEEN TESTED¹

Compound	Recommended Analysis ²	Compound	Recommended Analysis
Alachlor	GC/ECD	Folpet	GC/ECD
Aldrin	GC/ECD	Heptachlor	GC/ECD
Allethrin	HPLC/UV	Heptachlor epoxide	GC/ECD
Aroclor 1242	GC/ECD	Hexachlorobenzene	GC/ECD
Aroclor 1254	GC/ECD	Lindane (γ -BHC)	GC/ECD
Aroclor 1260	GC/ECD	Linuron	HPLC/UV
Atrazine	GC/NPD	Malathion	GC/NPD or FPD
Bendiocarb	HPLC/UV	Methyl parathion	GC/NPD or FPD
BHC (α - and β -Hexachlorocyclohexanes)	GC/ECD	Methoxychlor	GC/FCD
Captan	GC/ECD	Metolachlor	GC/ECD
Carbaryl	HPLC/UV	Mexacarbate	GC/FCD
Carbofuran	HPLC/UV	Mirex	GC/ECD
Chlordane, technical	GC/ECD	Monuron	HPLC/UV
Chlorothalonil	GC/ECD	Trans-nonachlor	GC/ECD
Chlorotoluron	HPLC/UV	Oxychlordane	GC/ECD
Chlorpyrifos	GC/ECD	Pentachlorobenzene	GC/ECD
2,4-D esters and salts	GC/ECD	Pentachlorophenol	GC/ECD
Dacthal	GC/ECD	Permethrin (cis and trans)	HPLC/UV
p,p' -DDT	GC/ECD	o -Phenylphenol	HPLC/UV
p,p' -DDE	GC/ECD	Phorate	GC/NPD or FPD
Diazinon	GC/NPD or FPD	Propazine	GC/NPD
Dicloran	GC/ECD	Propoxur (Baygon)	HPLC/UV
Dieldrin	GC/ECD	Pyrethrin	HPLC/UV
Dicofol	GC/ECD	Resmethrin	HPLC/UV
Dicrotophos	HPLC/UV	Ronnel	GC/ECD
Diuron	HPLC/UV	Simazine	HPLC/UV
Ethyl parathion	GC/NPD or FPD	Terbutiuron	HPLC/UV
Fenvalerate	HPLC/UV	Trifluralin	GC/ECD
Fluometuron	HPLC/UV		

¹ The following recommendations are specific for that analyte for maximum sensitivity.

² GC = gas chromatography; ECD = electron capture detector; FPD = flame photometric detector; HPLC = high performance liquid chromatography; NPD = nitrogen-phosphorus detector; UV = ultraviolet absorption detector; GC/MS = gas chromatography/mass spectrometry may also be used.

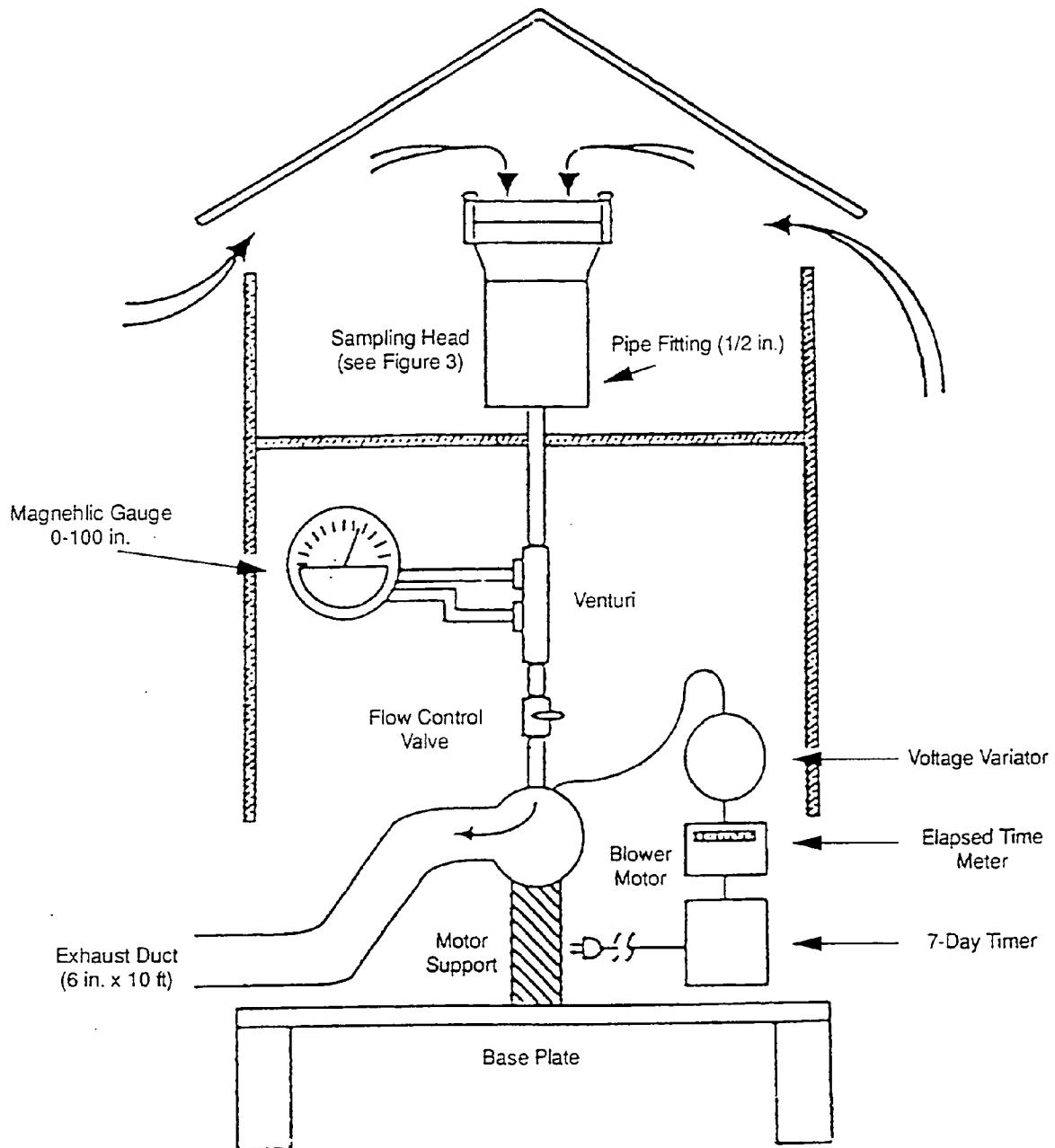

Figure 1. Typical high volume air sampler for monitoring common pesticides and PCBs.

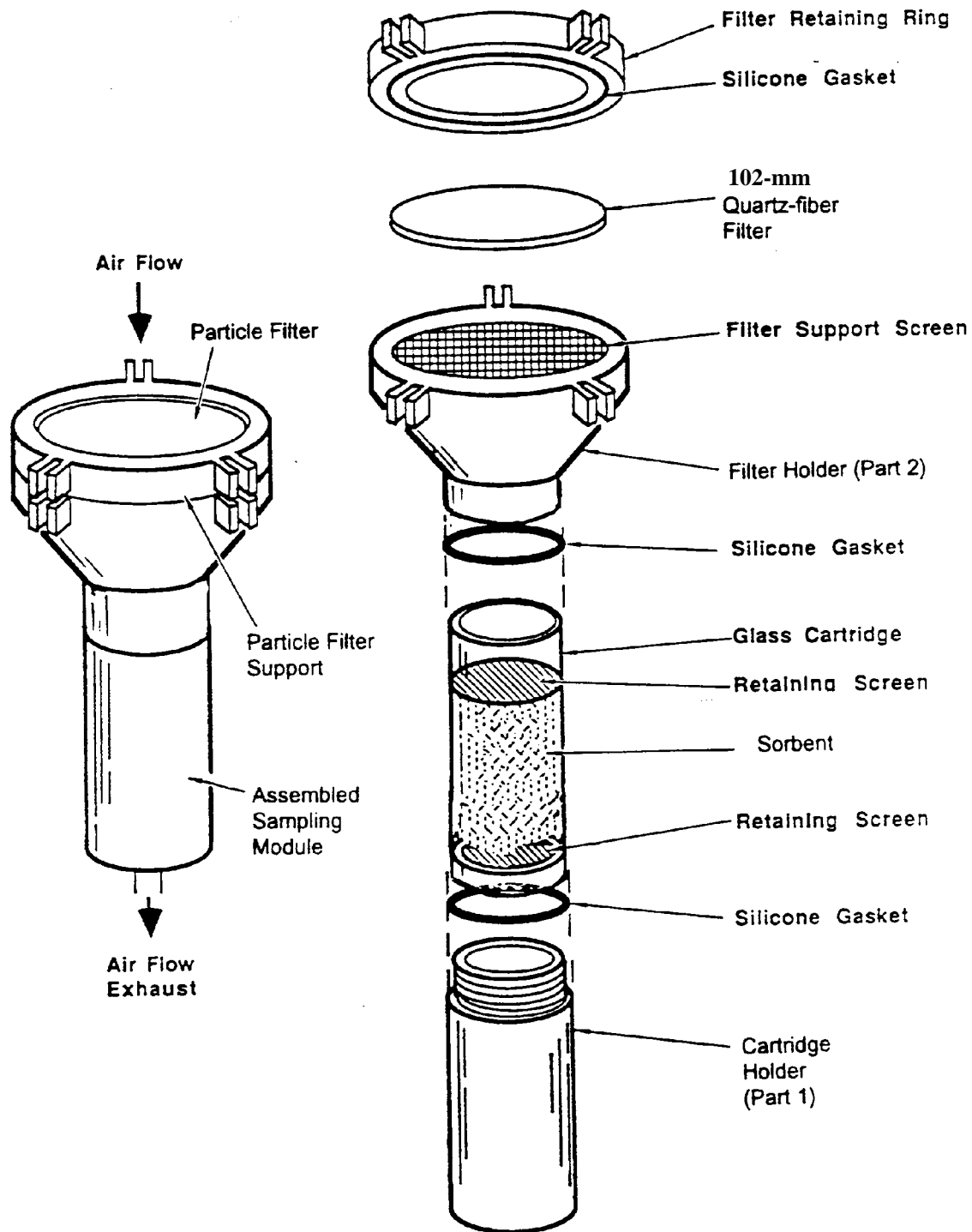

Figure 2. Typical absorbent cartridge assembly for sampling common pesticides and PCBs.

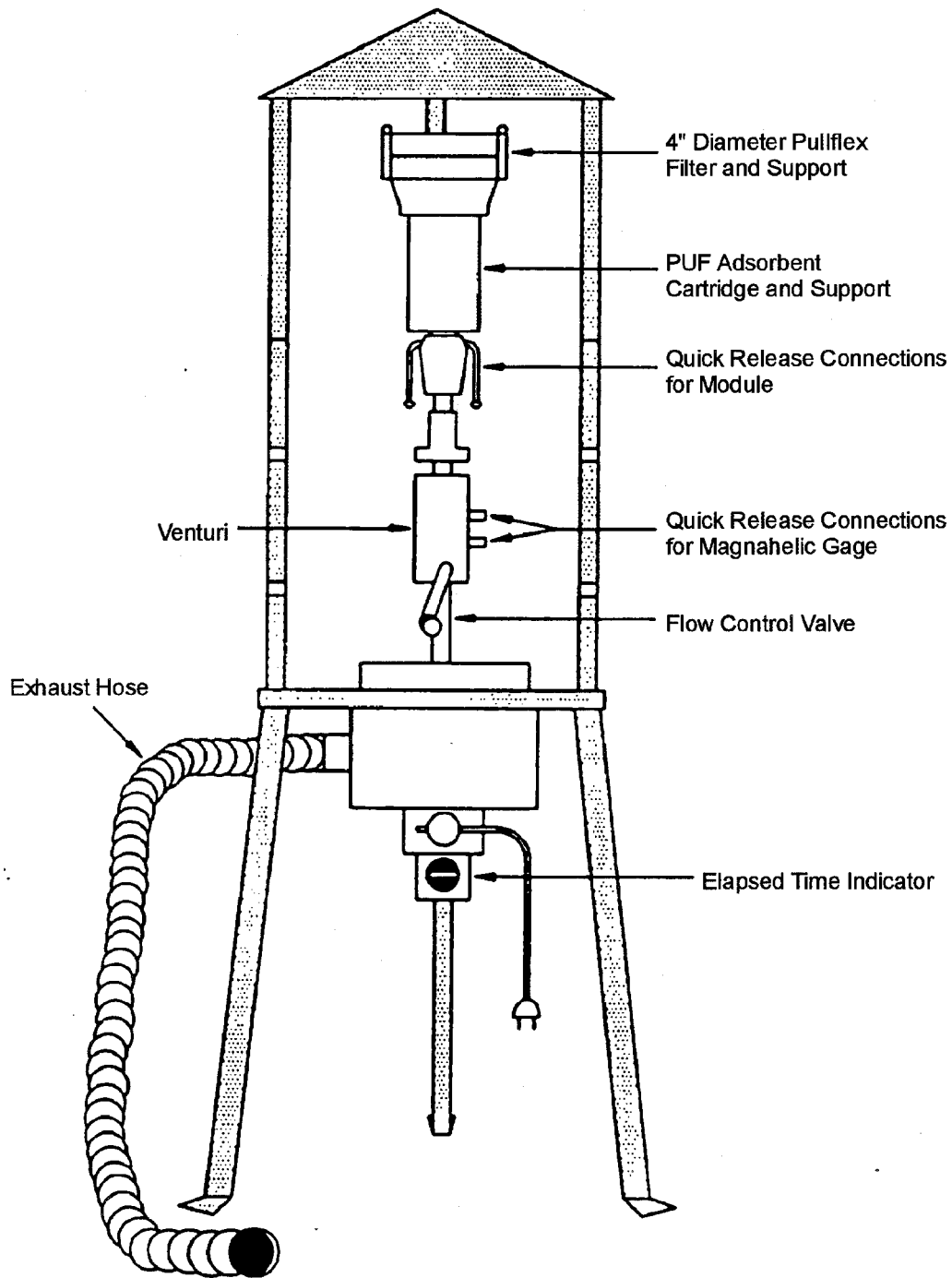

Figure 3. Portable high volume air sampler developed by EPA.

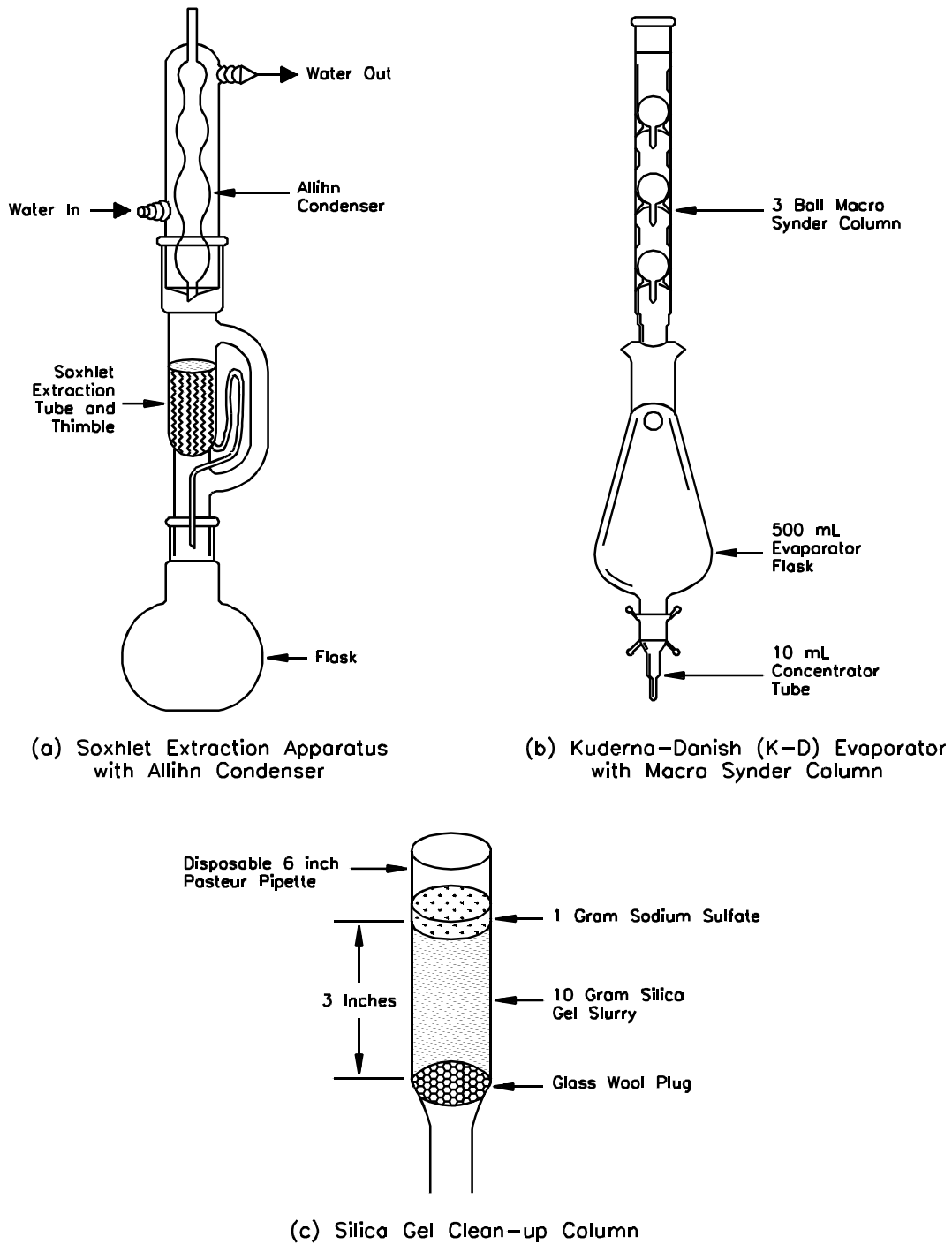
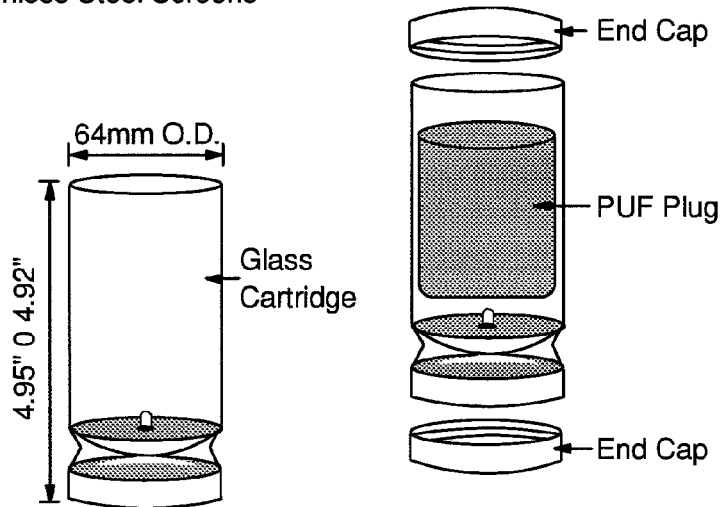
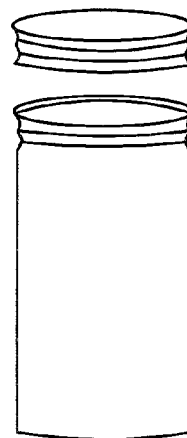
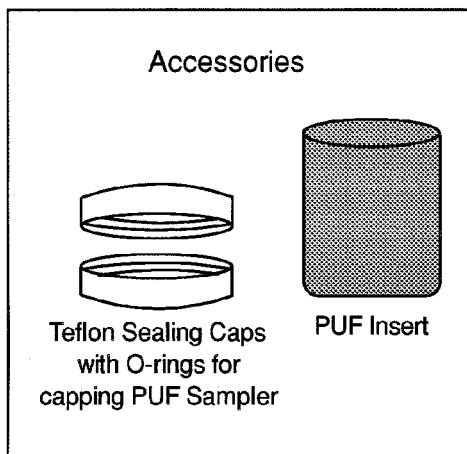

Figure 4. Apparatus used for sample clean-up and extraction.

Glass PUF Cartridge with
Stainless Steel Screens



5a. Glass PUF cartridge, plug, and end caps.



Aluminum Canister for Shipping
and Storage of the PUF Sampler

5b. PUF shipping container.

Figure 5. Glass PUF cartridge (5a) and shipping container (5b) for use with high-volume sampling systems.

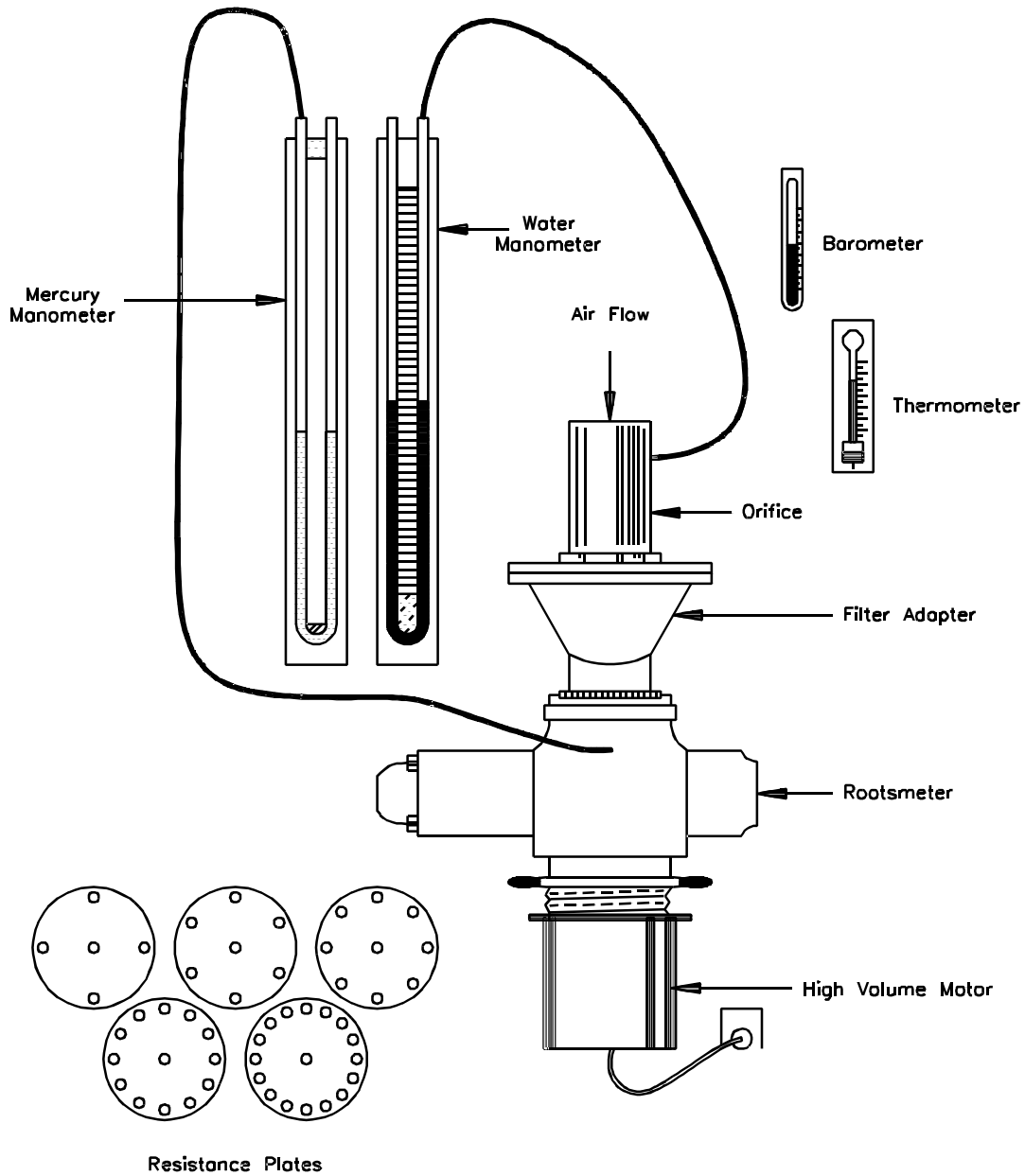

Figure 6. Positive displacement rootsmeter used to calibrate orifice transfer standard.

COMPENDIUM METHOD TO-4A
ORIFICE CALIBRATION DATA SHEET

T₁ _____ Name _____
 P₁ _____ Date _____
 _____ mmHg
 Orifice No. _____
 Rootsmer No. _____

Resistance Plants (No. of holes)	Air Volume Measured by Rootsmer V _m		Standard Volume, V _{std} (std m ³)	Time for Air Volume to Pass Through Rootsmer, θ (min)	Rootsmer Pressure Differential, ΔP (mm Hg)	Pressure Drop Across Orifice, ΔH (in. H ₂ O)	x-Axis Standard Flowrate, Q _{std} (std m ³ /min)	Y - axis $\sqrt{\Delta H(P_1/P_{std})(298/T_1)}$ value
	(R ³)	(m ³)						
5	200	5.66						
7	200	5.66						
10	300	8.50						
13	300	8.50						
18	300	8.50						

Factors: (R³)(0.02832 $\frac{m^3}{R^3}$) = m³ and (in. Hg) 25.4 ($\frac{mm\ Hg}{in.\ Hg}$) = mm Hg

Calculation Equations:

$$1. V_{std} = V_m \left(\frac{P_1 - \Delta P}{P_{std}} \right) \left(\frac{T_1}{T_{std}} \right)$$

where:

$$T_{std} = 296^\circ K$$

$$P_{std} = 760.0\ mm\ Hg$$

$$2. Q_{std} = \frac{V_{std}}{\theta}$$

Figure 7. Orifice calibration data sheet.

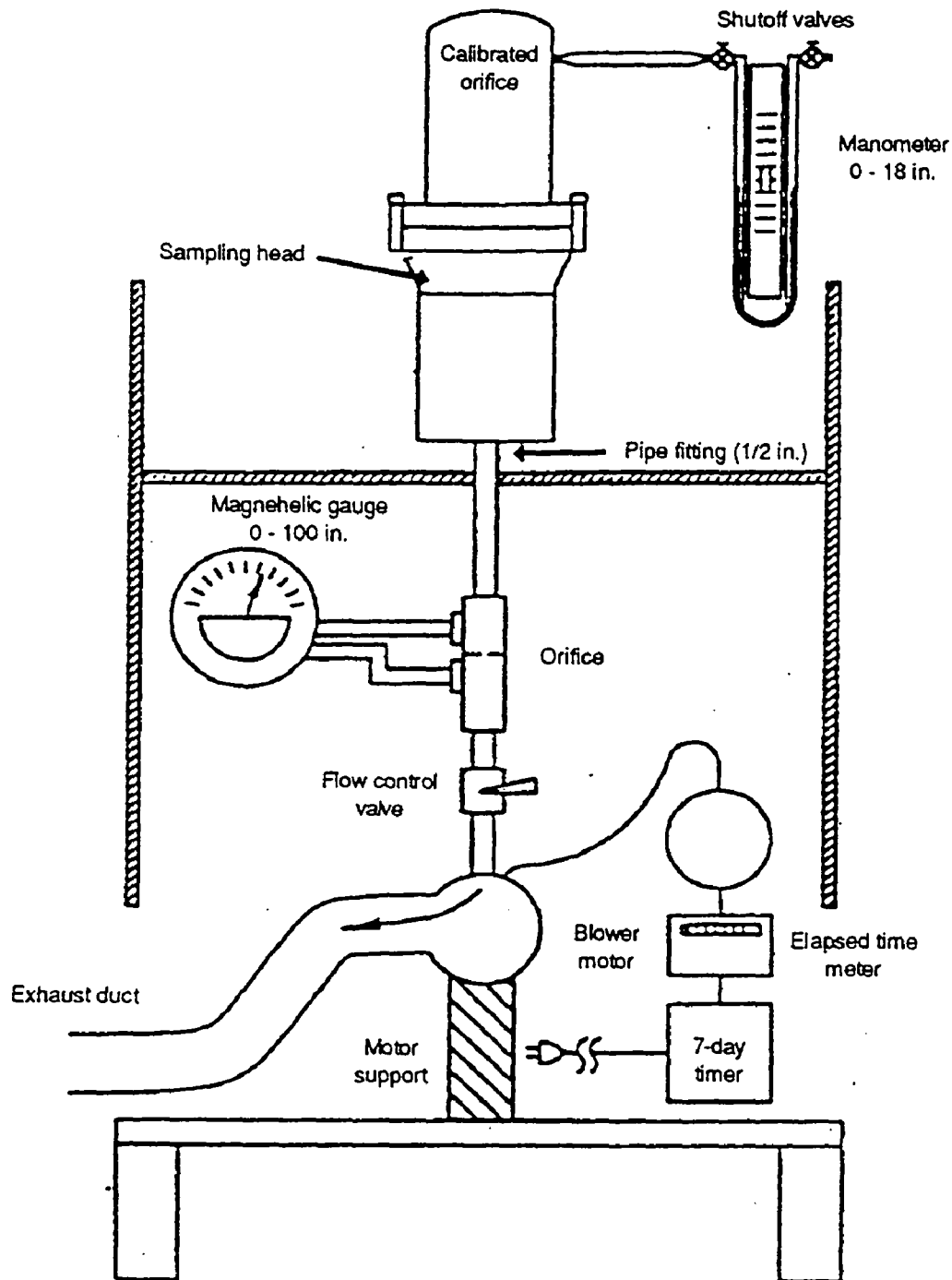

Figure 8. Field calibration configuration of the high-volume sampler for common pesticides and PCBs.

COMPENDIUM METHOD TO-4A
FIELD CALIBRATION DATA SHEET FOR SAMPLER CALIBRATION

Sampler ID: _____ Calibration Orifice ID: _____
 Sampler Location: _____ Job No.: _____
 High Volume Transfer Orifice Data:
 Correlation Coefficient (CC1): _____ Slope (M1): _____
 (CC2): _____ (M2): _____
 Intercept (B1): _____
 (B2): _____

Calibration Date: ____ Time: _____

Calibration Ambient Temperature: ____ °F ____ °C

CALIBRATOR'S SIGNATURE

Calibration Ambient Barometric Pressure: ____ "Hg ____ mm Hg

Calibration set point (SP): _____

SAMPLER CALIBRATION

Actual values from calibration		Calibrated values		
Orifice manometer, inches (Y1)	Monitor Magnehelic, inches (Y2)	Orifice manometer (Y3)	Monitor Magnehelic (Y4)	Calculated value orifice flow, scm (X1)
	70			
	60			
	50			
	40			
	30			
	20			
	10			

Definitions

Y1 = Calibration orifice reading, in. H₂O

Y2 = Monitor Magnehelic reading, in. H₂O

P_a = Barometric pressure actual, mm Hg

B1 = Manufacturer's Calibration orifice Intercept

M1 = Manufacturer's Calibration orifice manometer slope

Y3 = Calculated value for orifice manometer
 $= [Y1(P_a/760)(298/(T_a + 273))]^{1/2}$

Y4 = Calculated value for Magnehelic

$= [Y2(P_a/760)(298/(T_a + 273))]^{1/2}$

X1 = Calculated value orifice flow, scm

$= \frac{Y3 - B1}{M1}$

P_{std} = Barometric pressure standard, 760 mm Hg

T_a = Temperature actual, °C

T_{std} = Temperature standard, 25 °C

Figure 9. Orifice transfer standard field calibration data sheet.

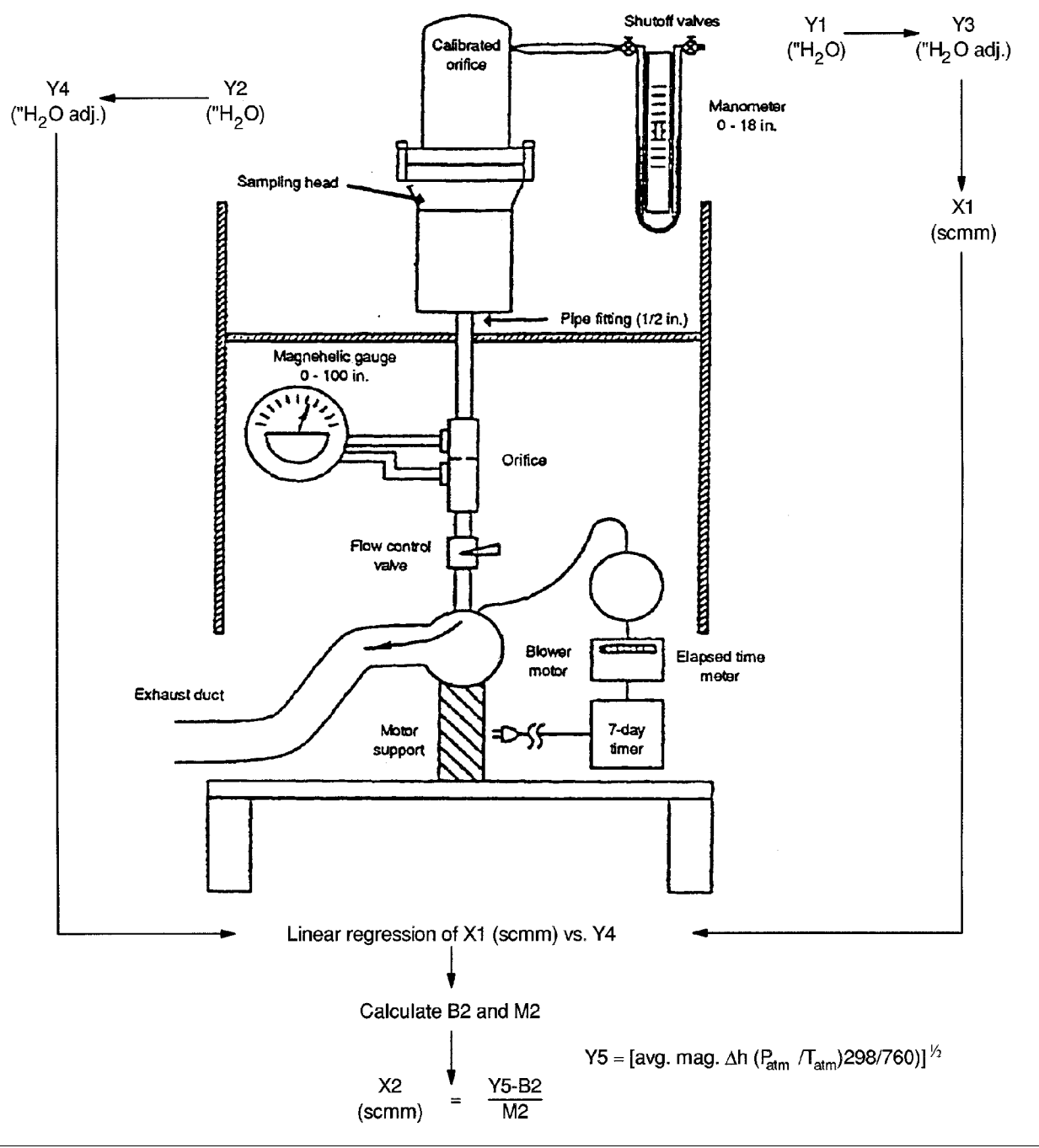

Figure 10. Relationship between orifice transfer standard and flow rate through sampler.

**COMPENDIUM METHOD TO-4A
FIELD TEST DATA SHEET
GENERAL INFORMATION**

Sampler I.D. No.: _____
 Lab PUF Sample No.: _____
 Sample location: _____

Operator: _____
 Other: _____

PUF Cartridge Certification Date: _____
 Date/Time PUF Cartridge Installed: _____
 Elapsed Timer: _____
 Start _____
 Stop _____
 Diff. _____

	Start	Stop
Barometric pressure ("Hg)	_____	_____
Ambient Temperature (°F)	_____	_____
Rain	Yes _____	Yes _____
	No _____	No _____

Sampling
 M1 _____ B1 _____
 M2 _____ B2 _____

Sampling time
 Start _____
 Stop _____
 Diff. _____

Audit flow check within ±10 of set point
 _____ Yes
 _____ No

TIME	TEMP	BAROMETRIC PRESSURE	MAGNEHELIC READING	CALCULATED FLOW RATE (scmm)	READ BY
Avg.					

Comments

Figure 11. Field test data sheet.

OPERATING CONDITIONS

Column Type: DB-5 0.32 capillary,
0.25 um film thickness
Column Temperature Program: 90°C(4min)/16°C per min to
154°C/4°C per min to 270°C.
Detector: Electron Capture
Carrier Gas: Helium at 1 mL/min.
Make Up Gas: 5% Methane/95% Argon at 60 mL/min.

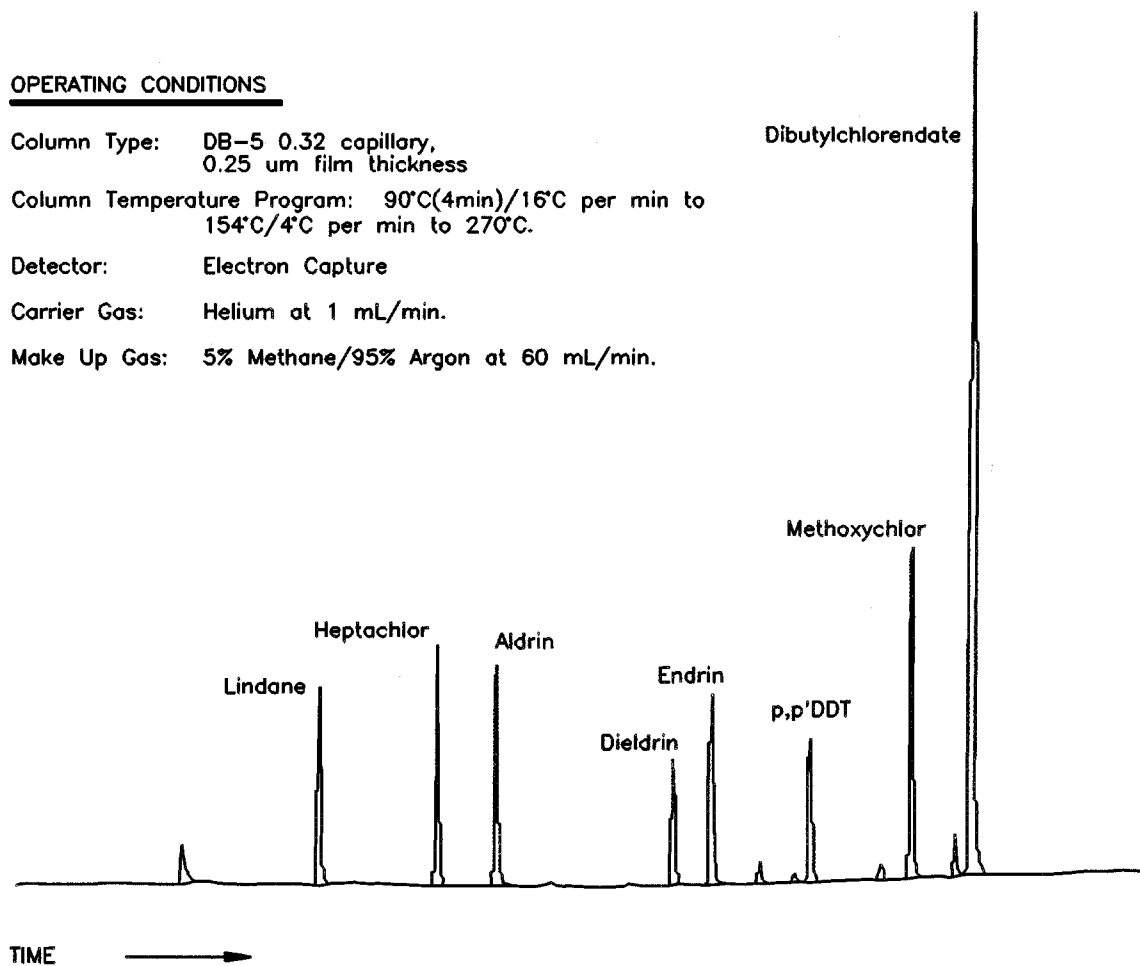

Figure 12. Chromatogram showing a mixture of single component pesticides determined by GC/ECD using a capillary column.

This Page Intentionally Left Blank