



Quality Assurance Handbook for Air Pollution Measurement Systems

**Volume IV: Meteorological Measurements
Version 2.0 (Final)**

EPA-454/B-08-002
March 2008

Quality Assurance Handbook for Air Pollution Measurement Systems
Volume IV: Meteorological Measurements Version 2.0 (Final)

U.S. Environmental Protection Agency
Office of Air Quality Planning and Standards
Air Quality Analysis Division
Measurement Technology and
Ambient Air Monitoring Groups
Research Triangle Park, North Carolina, 27711

Foreword

This document represents Volume 4 of a five-volume quality assurance (QA) handbook series. This volume is dedicated to meteorological measurement systems and their support equipment. Volume I provided general QA guidance that is pertinent to the remaining volumes. Volume II is dedicated to the Ambient Air Quality Surveillance Program and the data collection activities of that program. Volume III pertains to Source and Emission monitoring methods. Volume V pertains to ambient dry deposition.

This document, Volume IV, is designed to provide clear and concise information and guidance to the State/Local/Tribal (SLT) air pollution control agencies that operate meteorological monitoring equipment and systems. Recently, the new monitoring rule was published, which establishes the requirements for meteorological monitoring in support of National Core (NCore) network. The new monitoring rules require that meteorological data be collected at all NCore stations, as stated in the Code of Federal Regulations (CFR) Chapter 40 Section 58, Appendix D.3.b. Thus, there is a need for updated information to guide the SLT agencies as they implement the NCore network.

Since the last version of Volume IV was written, there have been a number of breakthroughs in instrument development and support equipment. The new “sonic” anemometer systems have been on the market for several years and this document will provide guidance on how best to operate those systems. In addition, there have been advancements in digital data acquisition where the signal from the sensor or the sensor’s translator box is a purely digital signal. Support equipment, such as data acquisition systems (DAS) have also changed in support to these new “state of the art” instruments that are now available.

As you read through this document, please be careful to note the references in the manual, as they may have World Wide Web Internet links associated with them. Where possible, the authors placed Internet links into the document so that if the reader wishes to get more in-depth or background material, then it is available through the link.

Another addition to this manual that is not in the other QA Handbooks is the links to audio/video files. This document will have Internet links in the calibration sections of 4.2 through 4.8 that will direct the reader to audio/video files posted on the EPA’s AMTIC website (<http://www.epa.gov/ttn/amtic/>). These audio/video files are short, but in-depth movies on how to calibrate/audit common meteorological instruments that are in use today.

Disclaimer of Endorsement

Mention of or referral to commercial products or services, and/or links to non-EPA sites does not imply official EPA endorsement of or responsibility for the opinions, ideas, data, or products presented at those locations, or guarantee the validity of the information provided. Mention of commercial products/services on non-EPA servers is provided solely as a pointer to information on topics related to environmental protection that may be useful to EPA staff and the public.

Contents

<i>Section</i>	<i>Page</i>	<i>Revision</i>	<i>Date</i>
Foreword.....	ii	1.0	03/24/08
Disclaimer of Endorsements.....	ii	1.0	03/24/08
Contents	iii	2.0	03/24/08
Acknowledgments.....	vi	2.0	03/24/08
Figures and Tables	vii	2.0	03/24/08
Introduction.....	1/17	2.0	01/20/08
0.1 Contents of the Handbook.....	1/17		
0.2 EPA Quality System.....	2/17		
1. Tower Guidance and Siting		2.0	01/20/08
1.1 Type of Towers	1/18		
1.2 Installation and Setup.....	3/18		
1.3 Tower Wiring	12/18		
1.4 Tower Siting.....	14/18		
2. Wind Speed and Direction		2.0	01/20/08
2.1 Introduction.....	1/27		
2.2 Types of Instruments and Specifications.....	1/27		
2.3 Acceptance Testing	4/27		
2.4 Installation, Instrument Exposure, and Wiring	5/27		
2.5 Calibration and Alignment	6/27		
2.6 Operation and Maintenance	16/27		
2.7 Auditing.....	17/27		
2.8 Scalar, Vector and Sigma Calculations	24/27		
2.9 Estimating Accuracy and Precision.....	27/27		
3. Temperature and Temperature Gradient		2.0	01/20/08
3.1 Types of Instruments and Specifications.....	1/6		
3.2 Acceptance Testing	2/6		
3.3 Installation and Wiring.....	2/6		
3.4 Calibration.....	4/6		
3.5 Operation and Maintenance	6/6		
3.6 Auditing.....	6/6		

<i>Section</i>	<i>Page</i>	<i>Revision</i>	<i>Date</i>
4. Rainfall and Precipitation		2.0	01/20/08
4.1 Types of Instruments and Specifications.....	1/6		
4.2 Acceptance Testing	4/6		
4.3 Calibration.....	4/6		
4.4 Operation and Maintenance	5/6		
4.5 Auditing.....	6/6		
5. Relative Humidity and Dew Point Determination		2.0	01/20/08
5.1 Types of Instruments and Specifications.....	1/4		
5.2 Acceptance Testing	2/4		
5.3 Installation and Wiring.....	3/4		
5.4 Calibration.....	3/4		
5.5 Operation and Maintenance	4/4		
5.6 Auditing.....	4/4		
6. Solar Radiation Measurements		2.0	01/20/08
6.1 Introduction.....	1/9		
6.2 Solar Radiation.....	1/9		
6.3 Types of Instruments.....	2/9		
6.4 Specifications	6/9		
6.5 Acceptance Testing	6/9		
6.6 Installation, Instrument Exposure, and Wiring	6/9		
6.7 Calibration.....	7/9		
6.8 Operations and Maintenance	8/9		
6.9 Auditing.....	9/9		
7. Atmospheric Pressure Measurements		2.0	01/20/08
7.1 Units and Scales	1/5		
7.2 Types of Instrumentation	1/5		
7.3 Acceptance Testing	2/5		
7.4 Installation and Instrument Exposure.....	3/5		
7.5 Calibration.....	5/5		
7.6 Operation and Maintenance	5/5		
7.7 Auditing.....	5/5		
8. Ground-Based Remote Sensing Devices		2.0	01/20/08
8.1 Types of Instruments and Specifications.....	2/28		
8.2 Acceptance Testing	11/28		
8.3 Installation and Siting.....	14/28		
8.4 Calibration.....	19/28		
8.5 Operation, Maintenance, and Quality Control.....	20/28		
8.6 Auditing.....	24/28		

<i>Section</i>	<i>Page</i>	<i>Revision</i>	<i>Date</i>
9. Data Acquisition Systems and Meteorology		2.0	01/20/08
9.1 Introduction	1/9		
9.2 DAS Data Acquisition in Analog Layout – Signal Conditioning	1/9		
9.3 Instrument Connectivity	1/9		
9.4 Data Communication.....	4/9		
9.5 Sampling Rates.....	4/9		
9.6 Meteorological Data Generated by DAS.....	5/9		
9.7 Identification of Data Acquisition Calculation Issues.....	8/9		
10. Meteorological Data Validation and Verification		2.0	01/20/08
10.1 General Approach	1/13		
10.2 Data Verification Methods	3/13		
10.3 Manual Review Methods	7/13		
10.4 Data Validation Methods	8/13		
11. New Technologies		2.0	01/20/08
11.1 Wind – Anemometers.....	1/6		
11.2 Temperature – Thermometers	2/6		
11.3 Pressure – Barometers.....	2/6		
11.4 Solar Radiation – Pyranometers	3/6		
11.5 Precipitation – Rain Gauges	4/6		
11.6 Upper-Air Measurements.....	4/6		
11.7 Multiple Parameter Weather Sensor.....	5/6		
12. References		2.0	01/20/08
Appendix A: Meteorological Systems Audit			
Evaluation Form.....	1/8	1.0	12/22/07
Appendix B: Examples of Meteorological Sensor			
Calibration Forms	1/3	1.0	12/22/07
Appendix C: Meteorological Measurement Methods Validation Criteria	1/12	2.0	01/20/08

Acknowledgments

Work on a document such as this requires the work and dedication of many people. This section acknowledges those that have provided their time and effort to create this document.

Team Lead: Dennis K. Mikel, EPA – OAQPS, AQAD

Team Co-lead: Nealsen Watkins, EPA – OAQPS, AQAD

Authors of the Chapters:

Chapter 0: Dennis Mikel, EPA – OAQPS, AQAD; Joey Landreneau, Sonoma Technology, Inc.

Chapter 1: Daniel Fields, Maricopa County Air Quality Department

Chapter 2: David Bush, T+B Systems, Inc.; Paul Roberts, Sonoma Technology, Inc.

Chapter 3: Paul Fransiola, T+B Systems Inc.

Chapter 4: Tammy Eagan, Florida Department of Environmental Protection

Chapter 5: Paul Fransiola, T+B Systems Inc.

Chapter 6: Dennis Mikel, EPA – OAQPS, AQAD; Joey Landreneau, Sonoma Technology, Inc.

Chapter 7: Kent Field, Ventura County APCD; Joey Landreneau, Sonoma Technology, Inc.

Chapter 8: Bob Baxter, T+B Systems Inc.; Tim Dye, Sonoma Technology, Inc.

Chapter 9: Dennis Mikel, EPA – OAQPS, AQAD, Gary Arcemont, San Joaquin Valley AQMD

Chapter 10: Dennis Mikel, EPA – OAQPS, AQAD

Chapter 11: Joey Landreneau, Sonoma Technology, Inc.

Appendix A: Dennis Mikel, EPA – OAQPS, AQAD

Appendix B: Dennis Mikel, EPA – OAQPS, AQAD

Appendix C: Richard Heffern, State of Alaska Dept. of Environmental Conservation

Editorial review and formatting were provided by Sonoma Technology, Inc. under contract with the EPA.

Comments and questions can be directed to:

Dennis Mikel or,

Nealsen Watkins

EPA-OAQPS-AQAD

109 Alexander Drive

Research Triangle Park, NC 27711

Email: mikel.dennisk@epa.gov

Watkins.nealsen@epa.gov

Figures

<i>Number</i>	<i>Title</i>	<i>Section Page</i>
0.1	The EPA Quality System	3/16
1.1	Telescopic Pole	2/18
1.2	Triangular Fixed	2/18
1.3	Triangular Adjustable	3/18
1.4	Pneumatic	3/18
1.5	Fold-Over	3/18
1.6	Ground Installation Procedure	4/18
1.7	Roof Installation Procedure	5/18
1.8	(a) Fascia Board Support; (b) Fence Post Guy Wire Anchor	7/18
1.9	(a) Angle Iron Support—Expanded View; (b) Angle Iron Support—Close-Up View	8/18
1.10	(a) Metal Wall Support—Telescopic Tower (Expanded View); (b) Metal Wall Support—Telescopic Tower (Close-Up View)	9/18
1.11	(a) Expanded View Guy Wire Harness—Telescopic Tower; (b) Close-Up View Guy Wire Harness—Telescopic Tower	10/18
1.12	Lightning Protection Installation	11/18
1.13	Signal Cable at Tower Base	12/18
1.14	Temperature Cable Installation and Expanded/Close-Up Views	13/18
1.15	Wiring on a Crank-Down Tower	14/18
1.16	Example of a Tower Location	17/18
1.17	Example of a Tower Attachment	18/18
2.1	Example of Cup and Vane System	2/27
2.2	Propeller Anemometer and Vane	3/27
2.3	2-D Sonic Anemometer	3/27
2.4	3-D Sonic Anemometer	3/27
2.5	Siting Wind Instruments	6/27
2.6	DC Motor Calibration	7/27
2.7	Torque Disk	7/27
2.8	Torque Disk in Testing Position	7/27
2.9	Waters Torque Watches	9/27
2.10	Magnetic Declinations for the United States	10/27

<i>Number</i>	<i>Title</i>	<i>Section Page</i>
2.11	True Geographic North and Magnetic North	10/27
2.12	Adjusting for (a) East and (b) West Declinations; (c) No Adjustment for Magnetic Declination of 0°	10/27
2.13	Side View of the Placement of a Compass or Transit for Measuring the Crossarm Direction	12/27
2.14	Top View Illustrating the Measurement of the Relative Direction of the Crossarm	12/27
2.15	Measurement of the Relative Direction of the Sun	12/27
2.16	Projection of Sun's Reflection Using a Brunton Pocket Transit	13/27
2.17	Linearity Test Fixture	20/27
2.18	Sensor Mounting for the Testing and Evaluation of the Audit Wind Sensor Against a Sonic Anemometer	22/27
2.19	Wind Speed Plot Showing the Mechanical Sensor (AQ) vs. the Sonic Anemometer for Wind Speeds Greater Than 1 ms ⁻¹	23/27
2.20	Wind Direction Plot Showing the Mechanical Sensor (AQ) vs. the Sonic Anemometer for Wind Speed Greater Than 1 ms ⁻¹	23/27
2.21	Typical Mounting of the Audit Sensors on the Site Tower	24/27
2.22	Calculated Wind Direction Averages from a Simulated 3,600-Sample Data Set	26/27
3.1	Example of a Platinum Wire Thermistor	1/6
3.2	A Naturally Ventilated Shield	3/6
3.3	A Motor-Aspirated Shield	3/6
4.1	Cylinder Precipitation Gauge	1/6
4.2	Automatic Wet/Dry Precipitation Collector	1/6
4.3	Universal-Weighing Gauge	2/6
4.4	Tipping Bucket Without the Shield	2/6
4.5	Example of an Alter Wind Shield	3/6
5.1	A Motor-Aspirated RH Shield	1/4
5.2	A Typical RH Probe	1/4
6.1	Solar Irradiance Versus Wavelength of Light Emitted by the Sun	2/9
6.2	Eppley Pyranometer PSP	3/9
6.3	Illustration of an Eppley Pyranometer	3/9
6.4	LiCor Pyranometer	5/9
6.5	NovaLynx Pyranometer	5/9
6.6	Eppley Normal Incidence Pyrheliometer	5/9

<i>Number</i>	<i>Title</i>	<i>Section Page</i>
6.7	Epply Solar Tracker	5/9
6.8	Net Radiometer	7/9
6.9	Absolute Cavity Pyrheliometer	8/9
7.1	Electronic Barometer	2/5
7.2	Portable Digital Barometer	2/5
7.3	NEMA 4X Enclosure	4/5
7.4	Tower-Mounted Barometer with Pressure Port	4/5
8.1	Schematic Showing the Differences Between In-Situ (Point) and Remote Sensor (Volume) Measurements	2/28
8.2	Schematic Showing the Transmitted and Received Signals From Sodars, Radar Wind Profilers, and RASS	4/28
8.3	Schematic Showing the Vertical and Oblique Beams	5/28
8.4	Schematic Showing a Beam Pattern for an Oblique Beam and its Associated Side Lobes	5/28
8.5	Schematic Showing a Monostatic and Bistatic Sodar System	7/28
8.6	Pictures of Different Types of Sodars: Mini-Sodar, Multi-Axis Sodar, Phased-Array Sodar	8/28
8.7	Photographs of Types of Radar Wind Profilers: Phased-Array System and Fixed-Axis Antenna System	9/28
8.8	Photographs of a Radar Wind Profiler with a RASS and a Sodar with a RASS	11/28
8.9	Example Site Layout Diagram	15/28
8.10	Example Site Vista Diagram	16/28
9.1	DAS Rear Panel with 8-Channel Differential Analog Terminal Strip	3/9
9.2	DAS Rear Panel with RS-232 Signal Interface	4/9
9.3	A Comparison of Trends at Two Nearby Stations	8/9
9.4	A Comparison of Scalar and Vector Wind Direction	9/9
10.1	Generalized Data Validation and Verification Process Flow	2/13
10.2	Example of Meteorological Sensor Visual Check List	5/13
10.3	Graphic Example of Temperature vs. Relative Humidity	9/13
10.4	Graphic Example of Ozone vs. Temperature	10/13
10.5	Example of a Meteorological Data Screening Checklist	13/13
11.1	Climatronics AIO	5/6
11.2	Vaisala WTX510	6/6

Tables

<i>Number</i>	<i>Title</i>	<i>Section Page</i>
0-1	PAMS Meteorological Measurement Quality Objectives	6/16
0-2	PAMS Calibration and Accuracy Criteria	7/16
0-3	NCore Meteorological Measurement Quality Objectives	8/16
0-4	NCore Calibration and Accuracy Criteria	9/16
0.5	SLAMS/SPM (non-NCore) Meteorological Measurement Quality Objectives	10/16
0.6	SLAMS/SPM (non-NCore) Verification/Calibration and Accuracy Criteria	10/16
0-7	PSD Measurement Quality Objectives	11/16
0-8	PSD Calibration and Accuracy Criteria	12/16
0-9	Modeling Application Measurement Quality Objectives	13/16
0-10	Modeling Application Calibration and Accuracy Criteria	14/16
0-11	National Weather Service Measurements Quality Objectives	15/16
0-12	Siting and Exposure for Meteorological Sensors	16/16
1-1	Description of Different Towers	1/17
1-2	Limits on Terrain and Obstacles Near Towers	15/17
2-1	Time Constant Effects	20/27
2-2	Proposed Audit Criteria for the Sonic Systems	23/27
8-1	Typical Specifications for Meteorological Remote Sensors	3/28
8-2	Characteristics of Radar Wind Profilers	8/28
8-3	Recommended Audit Criteria for Sodar, Radar Wind Profilers, and RASS	25/28
10-1	DAS Screening Techniques	6/13
11.1	Example Sonic Wind Sensors	1/6
11.2	Example Thermometers	2/6
11.3	Example Barometric Pressure Sensors	3/6
11.4	Example Pyranometers	3/6
11.5	Example Rain Gauges	4/6
11.6	Example Upper-Air Measurement Devices	5/6

0. Introduction

The purpose of the *Quality Assurance Handbook for Air Pollution Measurement Systems, Vol IV: Meteorological Measurements* (hereinafter called Handbook) is to provide information and guidance for meteorologists (applied and research), State/Local/Tribal (SLT) air pollution agency staff who operate meteorological equipment, SLT data reviewers who need validation guidance, and users of meteorological data. Methods that objectively define the quality of measurements needed for the intended use of the data are described in this version of the Handbook.

This version of the Handbook follows two previous versions that, for their time, were groundbreaking documents and paved the way for the air pollution monitoring community to begin and to continue collecting valid meteorological data. The first version of this Handbook was published in 1983¹, and it described the different meteorological systems that were available at that time. An updated version was published in 1990, with revisions and updates added in 1995.² The second version discussed methods and the equipment used within those methods in much greater detail as well as the calculation of vector and sigma data in detail, information that was lacking in the first version. Later revisions included a section on upper-air measurements and an appendix on Photochemical Assessment Monitoring Stations (PAMS) meteorological guidance. However, newer technologies have been developed since the second edition of the Handbook was published. This third version of the Handbook has a slightly different focus than the second version. This document is intended to be more “user friendly”—it will have as much practical information for those not trained to be meteorologists as those who are. This Handbook will discuss the practical uses and operation of meteorological equipment and data. Some of the very technical information has been removed or clarified, and illustrations have been updated. Internet links and references have been added throughout the document to allow the reader to research information quickly.

0.1 Contents of the Handbook

The first section of this Handbook describes the U.S. Environmental Protection Agency’s (EPA) Quality System (QS) and how it can be used to create a data collection system that gathers data of sufficient quality for its intended use. The tables of Measurement Quality Objectives (MQOs) in Section 0.2.2 will be useful to organizations planning meteorological monitoring programs. The tables will help users to quickly review the requirements of a particular program (i.e., PAMS versus NCore). If an agency is required to perform a particular type of monitoring, such as PAMS, Tables 0-1 and 0-9 clearly list all the MQOs and calibration and accuracy criteria so that the agency can make the right choices when purchasing or upgrading its equipment for a specific program.

- ▶ Section 1 focuses on meteorological towers, on which most equipment is mounted. The different types of towers and their application, including installation, setup, wiring, and lightning protection, are discussed in this section.
- ▶ Section 2 discusses wind speed and direction.
- ▶ Section 3 details temperature and temperature gradient.
- ▶ Section 4 deals with rainfall and precipitation.
- ▶ Section 5 illustrates relative humidity and dew point determinations.
- ▶ Section 6 discusses solar and total radiation.
- ▶ Section 7 discusses atmospheric pressure measurement.

- ▶ Section 8 describes upper-air systems, which include Radar Wind Profiler (RWP), Sodar (Sound Detection and Ranging) and RASS (Radio Acoustic Sounding Systems) instrumentation.
- ▶ Section 9 provides guidance on the advantages and disadvantages of analog and digital data acquisition.
- ▶ Section 10 provides a discussion of data validation and verification.
- ▶ Section 11 describes up-and-coming instruments and “new technology” that may not be widely used during the writing of this document, but will make an impact in the years to come.

Sections 2 through 8 describe the types of instruments currently available including information on acceptance testing, installation and wiring; calibration and alignment; operation and maintenance; and auditing. Sections 9 and 10 are new to this version of the Handbook and describe meteorological data acquisition systems (DAS) and meteorological data validation and verification.

Please note there are three appendices with this Handbook. The first appendix is a technical systems audit form that QA and QC staff can use to document the operation of meteorological collection devices and their associated equipment. Appendix B contains examples of sensor calibration forms. Appendix C was provided by the State of Alaska staff, which graciously provided measurement methods validation tables for their operations. These validation tables are provided only as examples for other SLT agencies to consider for their own use or adaptation.

0.2 EPA Quality System

The EPA document, “Guidance for the Data Quality Objective Process”³ states, “EPA Order 5360.1 A2 and the applicable federal regulations establish mandatory QS₁ that applies to all EPA organizations and organizations funded by EPA.” The guidance document describes the requirements, logic, and reasoning for establishing a QS: “Organizations must ensure that data collected for the characterization of environmental processes and conditions are of the appropriate type and quality for their intended use and which environmental technologies are designed, constructed, and operated according to defined expectations.” Systematic planning is a key project-level component of the EPA QS. Components of the QS are shown in Figure 0.1.

EPA policy is based on the national consensus standard, ANSI/ASQC E4-1994, *Specifications and Guidelines for Environmental Data Collection and Environmental Technology Programs*, developed by the American National Standards Institute and the American Society for Quality. This document describes the necessary management and technical elements for developing and implementing a QS by using a tiered approach. The standard recommends documenting (1) each organization-wide QS in a Quality Management Plan (QMP) or Quality Manual (to address requirements of *Part A: Management Systems* of the standard) and (2) the applicability of the QS to technical activity-specific efforts in a Quality Assurance Project Plan (QAPP) or similar document (to address the requirements of *Part B: Collection and Evaluation of Environmental Data* of the standard). EPA has adopted this tiered approach for its mandatory agency-wide QS. This document addresses Part B requirements of the standard for systematic planning for environmental data operations.

In accordance with EPA Order 5360.1 A2, EPA requires that environmental programs performed for or by the Agency be supported by data of the type and quality appropriate to their expected use. EPA defines

¹ QS: Quality System

environmental data as information collected directly from measurements, produced from models, or compiled from other sources such as databases or literature.

0.2.1 Data Quality Objectives

As stated in Section 0.2, EPA Order 5360.1 A2 requires that all EPA organizations (and organizations with extramural agreements with EPA) follow a systematic planning process to develop acceptance or performance criteria for the collection, evaluation, or use of environmental data. A systematic planning process is the first component in the *planning phase* of the project tier (see the bottom tier of Figure 0.1), while the actual data collection activities take place in the *implementation phase*.

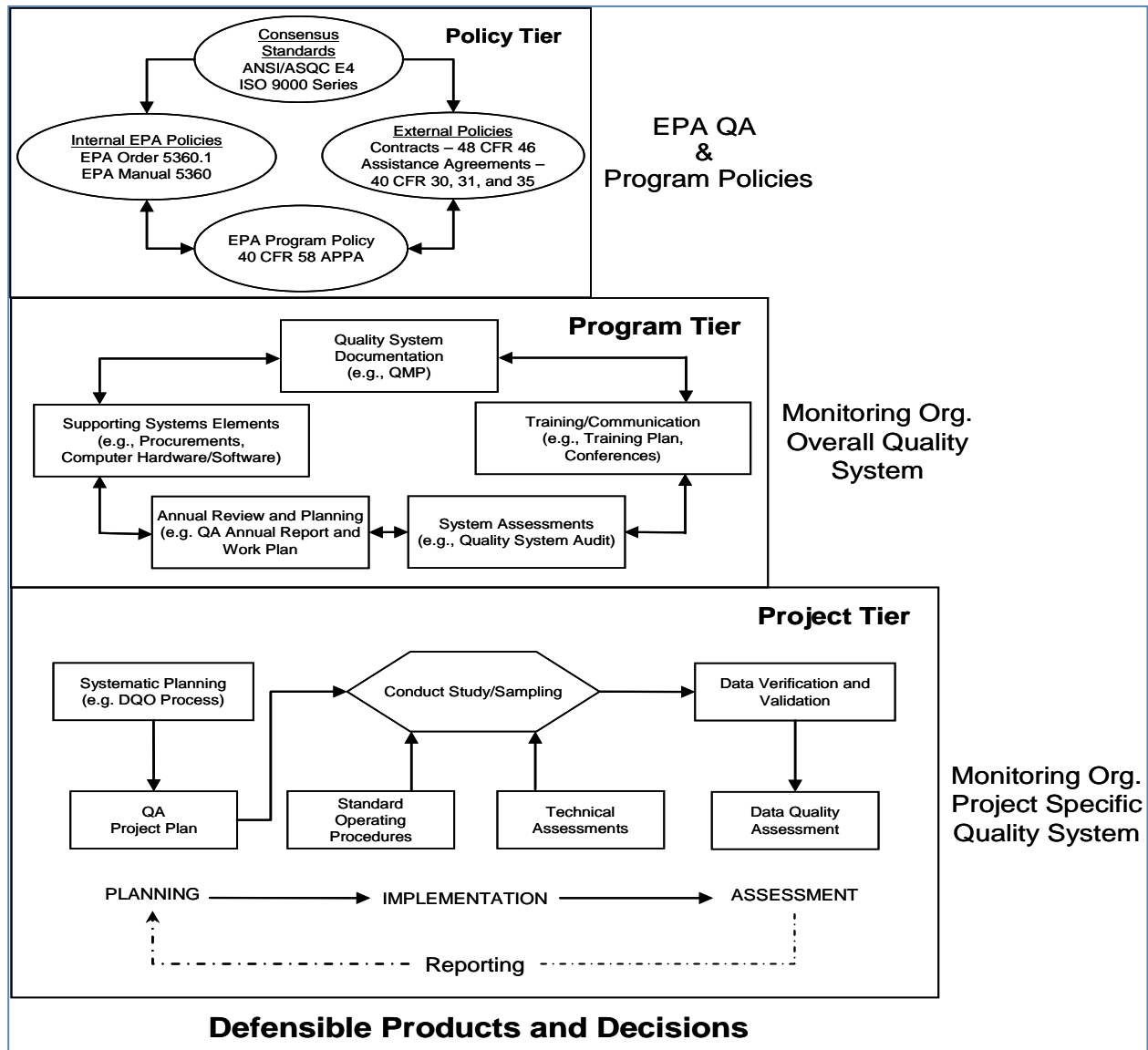

Figure 0.1 The EPA Quality System

Systematic planning is a planning process based on the scientific method and includes concepts such as objectivity of approach and acceptability of results. Systematic planning is a common-sense, graded approach to ensure that the level of detail in planning is commensurate with the importance and intended use of the work and available resources. This framework promotes communication among all organizations and individuals involved in an environmental program. Through a systematic planning process, a team can develop acceptance or performance criteria for the quality of the data collected and for the quality of the decision. When these data are being used in decision making by selecting between two clear alternative conditions (e.g., compliance/non-compliance with a standard), the EPA's recommended systematic planning tool is called the Data Quality Objective (DQO) Process.

The DQO Process is a seven-step planning approach to develop sampling designs for data collection activities that support decision making. This process uses systematic planning and statistical hypothesis testing to differentiate between two or more clearly defined alternatives.

- Step 1. Define the problem
- Step 2. Identify the problem
- Step 3. Identify information needed for the decision
- Step 4. Define the boundaries of the study
- Step 5. Develop a decision rule
- Step 6. Specify limits on decision errors
- Step 7. Optimize the design for obtaining data

The DQO Process is iterative and allows the planning team to incorporate new information and modify outputs from previous steps as inputs for a subsequent step. Although the principles of systematic planning and the DQO Process are applicable to all scientific studies, the DQO Process is particularly designed to address problems that require making a decision between two clear alternatives. The final outcome of the DQO Process is a design for collecting data (e.g., the number of samples to collect, and when, where, and how to collect samples).

The development and implementation of a quality system should be based on a "graded approach," that is, the components and tools of a quality system (Figure 0.1) apply according to the scope and nature of an organization, program, or project and the intended use of its products or services. This approach recognizes that a "one size fits all" approach to quality management is not appropriate and that the quality system of different organizations and programs should (and will) vary according to the specific needs of the organization. For example, the quality expectations of a research program are different from those of a regulatory compliance program because the intended use of the products differs. The same applies to meteorological data. Meteorological data can be used for a variety of reasons. The EPA has set forth a number of regulatory programs to understand the effects that pollution has on the health of the population. These programs include PAMS, National Core (NCore), Prevention of Significant Deterioration (PSD), and comparison of pollution data to the National Ambient Air Quality Standards (NAAQS). Monitoring agencies that use this guidance document are strongly encouraged to understand their data objectives, perform the DQO Process, if needed, and use the Measurement Quality Objectives (MQOs) described in Section 0.2.2 if they are applicable to an agency's program.

When an agency or entity is monitoring for non-regulatory purposes (e.g., background concentrations, modeling applications, or exposure), these MQOs are recommended guidance. Meeting MQOs for non-regulatory meteorological monitoring is strongly advised.

0.2.2 Measurement Quality Objectives

Once DQOs are designated for a program or project, measurement indicators must be determined to understand if the DQOs are being met. Most SLT agencies that collect data do so to support programs, such as PAMS, NCore, or PSD, that are federally mandated or that need to meet federal requirements. However, other non-regulatory applications exist, such as modeling applications, state implementation plan development, and forecasting. These programs require different meteorological MQOs since the application is different (i.e., different DQOs). Many SLT agencies also utilize National Weather Service (NWS) data available from nearby airports. The MQOs of the NWS data are included in Table 0-9. Agencies that use NWS data can reference these MQOs. The following prescribed objectives are listed in the MQO tables:

- ▶ Measurement – Type of parameter needed to be collected
- ▶ Method – Recommended; however, other methods are available and newer technologies will be developed. For regulatory programs, any alternative methods that are employed must meet these minimum requirements or recommendations.
- ▶ Reporting Units – Mandatory for regulatory programs (PAMS, PSD, and NCore); for non-regulatory programs, they are recommended only.
- ▶ Recommended Operating Range(s) – Typically employed but are not required.
- ▶ Detection Limits – Required for regulatory programs (PAMS, PSD, and NCore); the detection limit levels are mandatory. For non-regulatory programs, they are recommended only.
- ▶ Minimum Sample Frequency – Recommended.
- ▶ Raw Data Collection Frequency – Recommended.
- ▶ Completeness – Required for regulatory programs (PAMS, PSD, and NCore); the levels of completeness are mandatory. For non-regulatory programs, they are recommended only.
- ▶ Calibration – Recommended methods. Other methods may be employed; however, the levels of accuracy of other methods must meet the acceptance criteria.
- ▶ Accuracy – Required for regulatory programs (PAMS, PSD, and NCore); the levels of accuracy are mandatory. For non-regulatory programs, they are recommended only.
- ▶ Representativeness - Table 0-10 summarizes the recommended siting and exposure for most meteorological instruments.

Table 0-1 PAMS Meteorological Measurement Quality Objectives

Measurement	Method	Reporting Units	Operating Range	Resolution	Minimum Sample Frequency	Raw Data Collection Frequency	Completeness
Ambient Temperature	Thermistor	°C	-20 to 40	0.1	Hourly	1 minute	75%
Relative Humidity	Psychrometer/ Hygrometer	%	0–100	0.5% RH	Hourly	1 minute	75%
Barometric Pressure	Aneroid Barometer	hPa	800 – 1100	0.1	Hourly	1 minute	75%
Wind Speed	Cup, Blade or sonic anemometer	m/s	0.5 – 50.0	0.1	Hourly	1 minute	75%
Wind Direction	Vane or sonic anemometer	Degrees	0 – 360	1.0	Hourly	1 minute	75%
Solar Radiation	Pyranometer	Watts/m ²	0 – 1200	1.0	Hourly	1 minute	75%
UV Radiation	UV A and B Radiometer	Watts/m ²	0 – 12	0.01	Hourly	1 minute	75%
Precipitation	Tipping Bucket	mm/hr	0 – 30	0.25	Hourly	1 minute	75%
Upper-Air Meteorology Temp Relative Humidity Direction Wind speed	RWP, Sodar, RASS	°C % Degrees m/s	0 – 35 0 – 100 0 – 360 0 – 45	2.0 5.0 10 0.5	4 profiles per day	Per sounding	75%

Table 0-2 PAMS Calibration and Accuracy Criteria

Measurement	Calibration			Accuracy		
	Type	Acceptance Criteria	Frequency	Type	Acceptance Criteria	Frequency
Ambient Temperature	3 pt. Water Bath with NIST-traceable thermistor or thermometer	±0.5 °C	Semi-Annually	3 pt. Water Bath With NIST-traceable thermistor or Thermometer	±0.5 °C	Annually
Relative Humidity	NIST-traceable Psychrometer or standard solutions	±5% RH	Semi-Annually	NIST-traceable Psychrometer or standard solutions	±5% RH	Annually
Barometric Pressure	NIST-traceable Aneroid Barometer	±1 hPa	Semi-Annually	NIST-traceable Aneroid Barometer	±1 hPa	Annually
Wind Speed	NIST-traceable Synchronous Motor or CTS method ^a	±0.2 m/s + 5%	Semi-Annually	NIST-traceable Synchronous Motor	0.2 m/s + 5%	Annually
Wind Direction	Solar Noon, GPS or Magnetic Compass, CTS method ^a	±5 degrees	Semi-Annually	Solar Noon, GPS, or Magnetic Compass	±5 degrees	Annually
Solar Radiation	NIST-traceable Pyranometer	10 w/m ³ below 200 w/m ³ above 200 w/m ³ ±5%	Semi-Annually	NIST-traceable Pyranometer	10 w/m ³ below 200 w/m ³ above 200 w/m ³ ±5%	Annually
UV Radiation	NIST-traceable Radiometer	±5%	Semi-Annually	NIST-traceable Pyranometer	±5%	Annually
Precipitation	Separatory funnel and graduated cylinder	±10% of input volume	Semi-Annually	Separatory funnel and graduated cylinder	±10% of input volume	Annually
Upper-Air Meteorology Temp Relative Humidity Direction Wind speed	Tethered or Balloon Sonde with NIST-traceable Sensors	2.0 °C 5% 10 degrees 1 m/s	Semi-Annually	Tethered or Balloon Sonde with NIST-traceable Sensors	2.0 °C 5% 10 degrees 1 m/s	Annually

a. Collocated Transfer System Method (CTS) for sonic anemometers. This method is described in detail in Section 2.72 – 2.74 of this Handbook.

Table 0-3 NCore Meteorological Measurement Quality Objectives

Measurement	Method	Reporting Units	Operating Range	Resolution	Minimum Sample Frequency	Raw Data Collection Frequency	Completeness
(Required)							
Ambient Temperature	Thermistor	°C	-30 – 50	0.1	Hourly	1 minute	75%
Relative Humidity	Psychrometer/ Hygrometer	%	0 – 100	0.5	Hourly	1 minute	75%
Wind Speed	Cup, prop or sonic anemometer	m/s	0.5 – 50.0	0.1	Hourly	1 minute	75%
Wind Direction	Vane or sonic anemometer	Degrees	0 – 360 (540)	1.0	Hourly	1 minute	75%
Vector Data	DAS ² Calculations				Hourly		75%
Wind Speed		m/s	0 – 50.0	0.1		1 minute	
Wind Direction		degrees	0 – 360	1.0		1 minute	
(Optional)							
Solar Radiation	Pyranometer	Watts/m ²	0 – 1100	10	Hourly	1 minute	75%
Precipitation	Tipping Bucket	mm/hr	0 – 25 mm/hr	0.2 mm	Hourly	1 minute	75%
Barometric Pressure	Aneroid Barometer	mb	600 – 1100	0.5	Hourly	1 minute	75%

Table 0-4 NCore Calibration and Accuracy Criteria

Measurement	Verification/Calibration			Accuracy		
	Type	Acceptance Criteria	Frequency	Type	Acceptance Criteria	Frequency
Ambient Temperature	3 pt. Water Bath with NIST-traceable thermistor or thermometer	±0.5 °C	Semi-Annually	3 pt. Water Bath With NIST-traceable thermistor or thermometer	±0.5 °C	Annually
Relative Humidity	NIST-traceable Psychrometer or standards solution	±7% RH	Semi - Annually	NIST-traceable Psychrometer or standards solution	±7% RH	Annually
Wind Speed	NIST-traceable Synchronous Motor, CTS method ^a	±0.25m/s ≤5m/s; 5% >2m/s not to exceed 2.5m/s	Semi-Annually	NIST-traceable Synchronous Motor	0.25m/s ≤5m/s; 5% >2m/s not to exceed 2.5m/s	Annually
Wind Direction	Solar Noon, GPS Magnetic Compass, CTS method ^a	±5 degrees; includes orientation error	Semi-Annually	Solar Noon, GPS or Magnetic Compass	±5 degrees; includes orientation error	Annually
Solar Radiation	NIST-traceable Pyranometer	10 w/m ³ below 200 w/m ³ above 200 w/m ³ ±5%	Semi-Annually	NIST-traceable Pyranometer	10 w/m ³ below 200 w/m ³ above 200 w/m ³ ±5%	Annually
Barometric Pressure	NIST-traceable Aneroid Barometer	±3 mb	Semi-Annually	NIST-traceable Aneroid Barometer	±3 mb	Annually
Precipitation	Separatory funnel and graduated cylinder	±10% of input volume	Semi-Annually	Separatory funnel and graduated cylinder	±10% of input volume	Annually

a. This method is described in detail in Section 2.72 – 2.74 of this Handbook.

Table 0-5. SLAMS/SPM (non-NCore) Meteorological Measurement Quality Objectives

Measurement	Method	Reporting Units	Operating Range	Resolution	Minimum Sample Frequency	Raw Data Collection Frequency	Completeness
Ambient Temperature	Thermistor	°C	-30 – 50	0.5	Hourly	1 minute	75%
Relative Humidity	Psychrometer/ Hygrometer	%	0 – 100	1.0	Hourly	1 minute	75%
Wind Speed	Cup, prop or sonic anemometer	m/s	0.5 – 50.0	0.2	Hourly	1 minute	75%
Wind Direction	Vane or sonic anemometer	Degrees	0 – 360 (540)	1.0	Hourly	1 minute	75%

Table 0-6. SLAMS/SPM (non-NCore) Verification/Calibration and Accuracy Criteria

Measurement	Verification/Calibration			Accuracy		
	Type	Acceptance Criteria	Frequency	Type	Acceptance Criteria	Frequency
Ambient Temperature	3 pt. Water Bath with NIST-traceable thermistor or thermometer	±1.0 °C	Annually	3 pt. Water Bath With NIST-traceable thermistor or thermometer	±1.0 °C	Annually
Relative Humidity	NIST-traceable Psychrometer or standards solution	±10% RH	Annually	NIST-traceable Psychrometer or standards solution	±10% RH	Annually
Wind Speed	NIST-traceable Synchronous Motor, CTS Method	±0.25m/s ≤5m/s; 5%>2m/s not to exceed 2.5m/s	Annually	NIST-traceable Synchronous Motor	0.25m/s ≤5m/s; 5%>2m/s not to exceed 2.5m/s	Annually
Wind Direction	Solar Noon, GPS Magnetic Compass, CTS Method	±5 degrees; includes orientation error	Annually	Solar Noon, GPS or Magnetic Compass	±5 degrees; includes orientation error	Annually

This method is described in detail in Section 2.72 – 2.74 of this Handbook.

Table 0-7 PSD Measurement Quality Objectives

Measurement	Method	Reporting Units	Operating Range	Resolution	Minimum Sample Frequency	Raw Data Collection Frequency	Completeness
Ambient Temperature	Thermistor	°C	-30 – 50	0.1	Hourly	1 minute	90%
Vertical Temperature Difference	Thermistor	°C	-3 – 7	0.1	Hourly	1 minute	90%
Relative Humidity	Psychrometer/ Hygrometer	%	0 – 100	0.5	Hourly	1 minute	90%
Dew Point	Psychrometer/ Hygrometer	°C	-30 – +30	0.1	Hourly	1 minute	90%
Barometric Pressure	Aneroid Barometer	Mb	600 – 1100	0.5	Hourly	1 minute	90%
Wind Speed	Cup or sonic anemometer	m/s	0.5 – 50.0	0.25	Hourly	1 minute	90%
Wind Direction	Vane or sonic anemometer	Degrees	0 – 360 (540)	1.0	Hourly	1 minute	90%
Solar Radiation	Pyranometer	Watts/m ²	0 – 1300	10	Hourly	1 minute	90%
Vertical Wind Speed	Vane or sonic anemometer	m/s	-25.0 to 25.0	0.1	Hourly	1 minute	90%
Vector Data Wind Speed Wind Direction Sigma Theta Sigma W	DAS Calculations	m/s degrees degrees m/s	0 – 50.0 0 – 360 0 – 105 0 – 10	0.1 1.0 1.0 0.1	Hourly	1 minute 1 minute 15 minute 1 minute	90%
Precipitation	Tipping Bucket	mm/hr	0 – 50 mm /hr	0.2 mm/hr	Hourly	5 minute	90%

Table 0-8 PSD Calibration and Accuracy Criteria

Measurement	Calibration			Accuracy		
	Type	Acceptance Criteria	Frequency	Type	Acceptance Criteria	Frequency
Ambient Temperature	3 pt. Water Bath with NIST-traceable thermistor or thermometer	±0.5 °C	Quarterly	3 pt. Water Bath With NIST-traceable thermistor or Thermometer	±0.5 deg. C	Within 60 days of startup and 6 month intervals
Vertical Temperature Difference	3 pt. Water Bath with NIST-traceable thermistor or thermometer	±0.1°C	Quarterly	3 pt. Water Bath with NIST-traceable thermistor or thermometer	±0.1°C	Within 60 days of startup and 6 month intervals
Relative Humidity	NIST-traceable Psychrometer or standard solutions	±7% RH	Quarterly	NIST-traceable Psychrometer or standard solutions	±7% RH	Within 60 days of startup and 6 month intervals
Dew Point	NIST-traceable Psychrometer or standard solutions	±1.5°C	Quarterly	NIST-traceable Psychrometer or standard solutions	±1.5°C	Within 60 days of startup and 6 month intervals
Barometric Pressure	NIST-traceable Aneroid Barometer	±3 mb	Quarterly	NIST-traceable Aneroid Barometer	±3 mb	Within 60 days of startup and 6 month intervals
Wind Speed	NIST-traceable Synchronous Motor, CTS Method ^a	±0.2 m/s	Quarterly	NIST-traceable Synchronous Motor	±0.2 m/s	Within 60 days of startup and 6 month intervals
Wind Direction	Solar Noon, GPS Magnetic Compass, CTS Method ^a	±5 degrees includes orientation error	Quarterly	Solar Noon, GPS, or Magnetic Compass	±5 degrees includes orientation error	Within 60 days of startup and 6 months thereafter
Solar Radiation	NIST-traceable Pyranometer	10 w/m ³ below 200 w/m ³ above 200 w/m ³ ±5%	Quarterly	NIST-traceable Pyranometer	10 w/m ³ below 200 w/m ³ above 200 w/m ³ ±5%	Within 60 days of startup and 6 month intervals
Vertical Wind Speed	NIST-traceable Synchronous Motor	±0.2 m/s	Quarterly	NIST-traceable Synchronous Motor	±0.2 m/s	Within 60 days of startup and 6 month intervals
Vector Data Wind Speed Wind Direction Sigma Theta Sigma W	Voltmeter and Voltage Generator	±0.2 m/s ±5 degrees ±5 degrees ±0.2 m/s	Quarterly	Voltmeter and Voltage Generator	±0.2 m/s ±5 degrees ±5 degrees ±0.2 m/s	Within 60 days of startup and 6 month intervals
Precipitation	Separatory funnel and graduated cylinder	±10% of input volume	Quarterly	Separatory funnel and graduated cylinder	±10% of input volume	Within 60 days of startup and 6 month intervals

a. This method is described in detail in Section 2.72 – 2.74 of this Handbook.

Table 0-9 Modeling Application Measurement Quality Objectives⁴

Measurement	Method	Reporting Units	Operating Range	Resolution	Minimum Sample Frequency	Raw Data Collection Frequency	Completeness
Ambient Temperature	Thermistor	°C	-40 – 60	0.1	Hourly	1 minute	90%
Dew Point Temperature	Psychrometer/ Hygrometer	°C	-40 – 60	0.1	Hourly	1 minute	90%
Vertical Temperature Diff.	Thermistor	°C	-5 – 15	0.02	Hourly	1 minute	90%
Barometric Pressure	Aneroid Barometer	mb	600 – 1100	0.5	Hourly	1 minute	90%
Wind Speed	Cup, blade, or sonic anemometer	m/sec	0.5 – 50.0	0.1	Hourly	1 minute	90%
Wind Direction	Vane or sonic anemometer	Degrees	0 – 360 (540)	0.5	Hourly	1 minute	90%
Solar Radiation	Pyranometer	Watts/m ²	0 – 1300	10	Hourly	1 minute	90%
Upper-Air Meteorology Temp Direction Wind speed	RWP, Sodar, RASS	°C degrees m/sec	0 – 35 0 – 360 0 – 45	1.0 10 1.0	15 minute/ Hourly Soundings	15 minute	90%
Vector Data Wind Speed Wind Direction Sigma Theta Sigma W	DAS Calculations	m/s degrees degrees m/s	0 – 50.0 0 – 360 0 – 105 0 – 10	0.1 1.0 1.0 0.1	Hourly	1 minute	90%
Precipitation	Tipping Bucket	mm/hr	0 – 25 mm/hr	0.25 mm	Hourly	1 minute	90%

Table 0-10 Modeling Application Calibration and Accuracy Criteria

Measurement	Calibration			Accuracy		
	Type	Acceptance Criteria	Frequency	Type	Acceptance Criteria	Frequency
Ambient Temperature	3 pt. Water Bath with NIST-traceable thermistor or thermometer	±0.5 °C	Semi-Annually	3 pt. Water Bath With NIST-traceable thermistor or Thermometer	±0.5 °C	Annually
Dew Point Temperature	NIST-traceable Psychrometer or standards solution	±0.5 °C	Semi-Annually	NIST-traceable Psychrometer or standards solution	±0.5 °C	Annually
Vertical Temp. Diff.	3pt. Water Bath with NIST-traceable thermistor or thermometer	±0.1 °C	Semi-Annually	NIST-traceable Psychrometer	±0.1 °C	Annually
Precipitation	Separatory funnel and graduated cylinder	±10% of input volume	Semi-Annually	Separatory funnel and graduated cylinder	±10% of input volume	Annually
Wind Speed	NIST-traceable Synchronous Motor, CTS method ^a	±0.2 m/s	Semi-Annually	NIST-traceable Synchronous Motor	±0.2 m/s	Annually
Wind Direction	Solar Noon, GPS, Magnetic Compass, CTS method ^a	±3 – 5 degrees	Semi Annually	Solar Noon, GPS or Magnetic Compass	±3 – 5 degrees	Annually
Solar Radiation	NIST traceable Pyranometer	10 w/m ³ below 200 w/m ³ above 200 w/m ³ ±5%	Semi-Annually	NIST-traceable Pyranometer	10 w/m ³ below 200 w/m ³ above 200 w/m ³ ±5%	Annually
Vertical Wind Speed	NIST-traceable Synchronous Motor	±0.2 m/s	Semi-Annually	NIST-traceable Synchronous Motor	±0.2 m/s	Annually
Upper-Air Meteorology Temp Direction Wind speed	Tethered or Balloon Sonde with NIST-traceable Sensors	±0.2 °C ±10 degrees ±1 m/s	Semi-Annually	Tethered or Balloon Sonde with NIST-traceable Sensors	±0.2 °C ±10 degrees ±1 m/s	Annually
Vector Data Wind Speed Wind Direction Sigma Theta Sigma W	Voltmeter and Voltage Generator	±0.2 m/s ±5 degrees ±5 degrees ±0.2 m/s	Semi-Annually	Voltmeter and Voltage Generator	±0.2 m/s ±5 degrees ±5 degrees ±0.2 m/s	Annually

a. This method is described in detail in Section 2.72 – 2.74 of this Handbook.

Table 0-11 National Weather Service Measurements Quality Objectives⁵

Measurement	Method	Reporting Units	Operating Range	Resolution	Accuracy
Ambient temperature	Liquid in glass or electronic	°C	-62 to -50 -50 to +50 +50 to +54	0.1 0.1 0.1	±1.1 ±0.6 ±1.1
Dew point temperature	Psychrometer	°C	-34 to -24 -24 to -01 -01 to +30	0.1 0.1 0.1	±2.2 ±1.7 ±1.1
Barometric pressure	Barometer	in Hg	22 – 35	0.005	±0.02
Wind speed and character	Cup or sonic anemometer	knots	2 to 90	1.0	±1 up to 10 ±10% above 10
Wind direction	Vane or sonic anemometer	Degrees	0 – 360	10	±5 when speed is ≥ 5 knots
Sunshine sensor	Pyranometer	Watts/m ²	0 – 1200	1 minute	±10%
Cloud height	Ceilometer	feet	0 – 12,000	Height of Cloud Base	±3%
Precipitation (liquid)	Tipping bucket	in/hr	0 – 10	0.01	±0.02 or 4% of hourly amount
Altimeter	Altimeter	in Hg	22 – 35	0.01	±0.02

Table 0.12 Siting and Exposure for Meteorological Sensors^a

Measurement	Distance from Obstruction	Distance Above Ground	Recommended Group Cover	Comments
Wind Speed/Direction	10x the height of the obstruction	10 meters	Grass or gravel	The standard exposure of the wind instruments over level, open terrain is 10 meters above ground
Temperature/Dew Point	1.5x the tower diameter	1.25 to 2 meters	Non-irrigated or un-watered short grass, or natural earth	The surface should not be concrete or asphalt or oil-soaked. Reflection from these surfaces may affect the performance of the sensor.
Vertical Temperature Difference	1.5x the tower diameter	2 meters and 10 meters	Non-irrigated or un-watered short grass, or natural earth	The surface should not be concrete or asphalt or oil-soaked. Reflection from these surfaces may affect the performance of the sensor.
Solar Radiation	2 meters	2 to 10 meters	No requirements	Sensor should be free from obstructions above the plane of the sensor. It should be located so that shadows will not cast on the device.
Barometric pressure	1meter	1 to 10 meters	No requirements	The location should have uniform, constant temperature, shielded from the sun, away from drafts or heaters
Precipitation	2x to 4x the obstruction height	30 cm, minimum	Natural vegetation or gravel	Asphalt or concrete should be avoided to avoid splashing the gage. The gage should be high enough to avoid it being covered by snow.

^a **Note:** More details on siting and exposure are available in the individual sections of this Handbook. Please see the installation section of each chapter for more information.

1. Tower Guidance and Siting

Meteorological towers support various types of meteorological equipment. There are many types of towers and several ways to install them. Proper installation and siting of towers determine the effectiveness of a system and ensure ease of maintenance and reliability. Note: climbing towers to perform maintenance tasks is hazardous; use all necessary precautions as outlined in agency-specific Health and Safety Plans (HASPs).

This section focuses on stationary meteorological towers that are installed at permanent air monitoring sites. The different towers and the methods used to install them are described in the following sections.

1.1 Types of Towers

Numerous types of towers may be used to host a system. The type of tower that should be used will be determined by the location, the type of support structures available, and the desired height of the tower. In most cases, to accommodate wind speed/wind direction sensors, a meteorological tower must be able to reach a height of 10 m. Therefore, if a tower will be mounted on an existing structure, the structure should be measured first to determine what height the tower should be. Once the tower height has been determined, the tower type may be identified. The most common types of towers are listed in Table 1-1. Figures 1.1 through 1.5 illustrate tower examples.

Table 1-1 Description of Different Towers

Type of Tower	Advantages	Disadvantages
Telescopic pole	Inexpensive, good for applications of 10 m or less	Difficult to install, hard to align, hard to raise and lower
Triangular fixed	Simple to wire, easy to align, mid-price range	Hard to raise and lower, difficult to QA and QC
Triangular adjustable (crank-up towers)	Simple to wire, easy to align, easy to raise and lower	Expensive, does not work well with delta-t temperature systems
Pneumatic	Easy to raise and lower, good for mobile applications	Very expensive, not practical for stationary monitoring sites
Fold-Over	Single worker can access instruments without climbing, hand winch lowers upper section for quick access, easy to align,	Expensive in comparison to tilt-down triangle towers

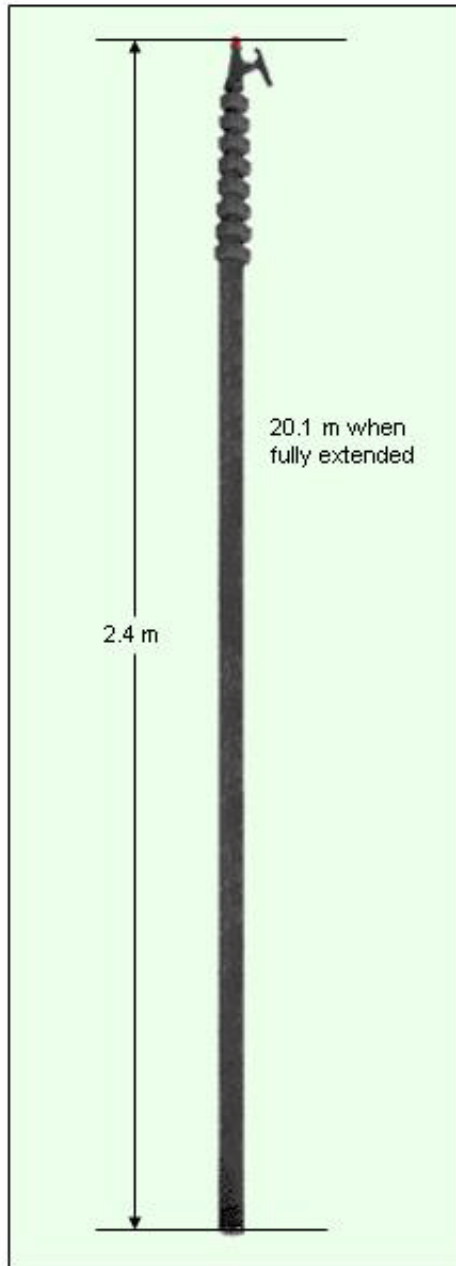

Figure 1.1 Telescopic Pole⁶

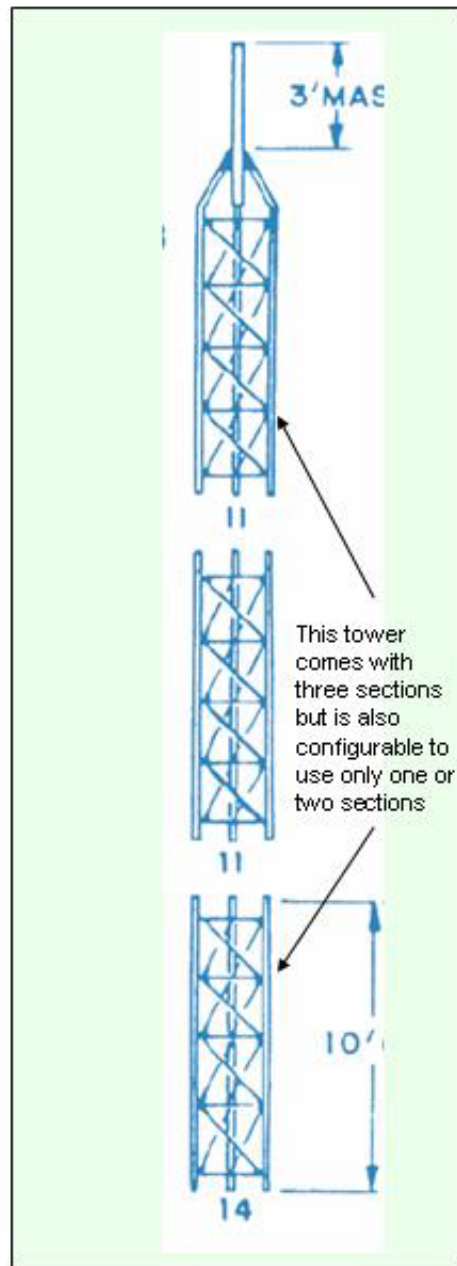

Figure 1.2 Triangular Fixed

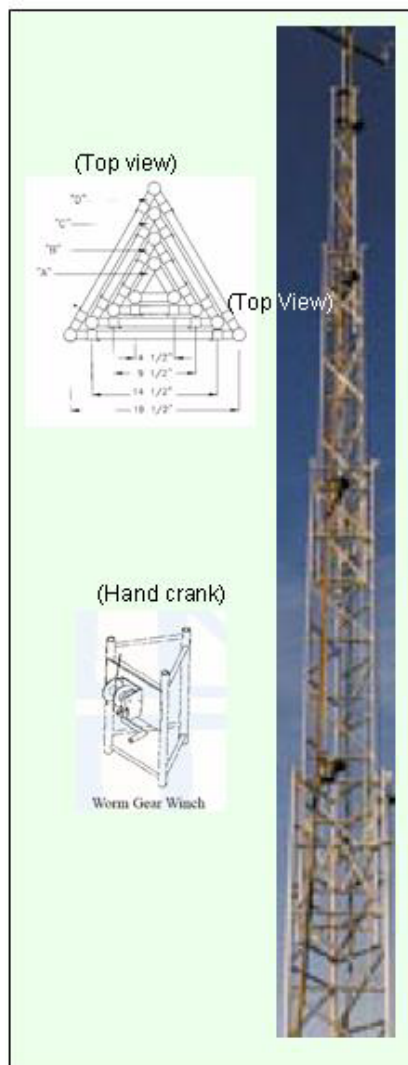

Figure 1.3 Triangular Adjustable⁹



Figure 1.4 Pneumatic⁷

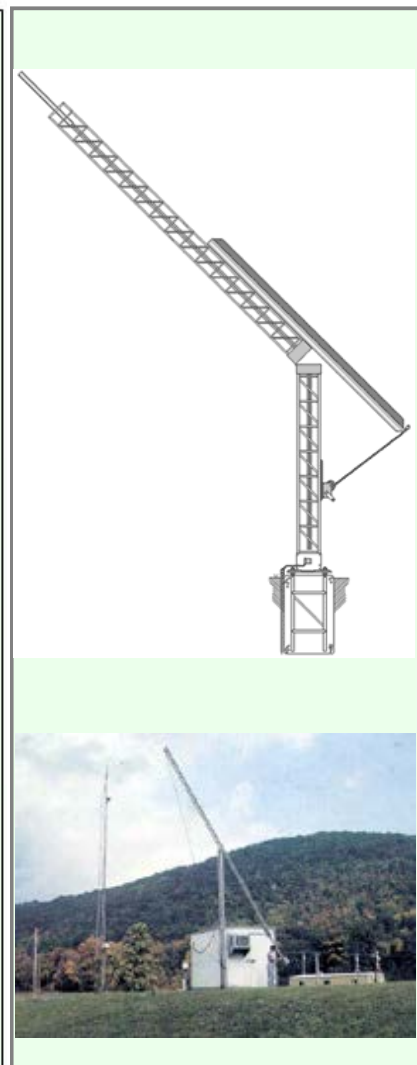

Figure 1.5 Fold-Over⁸

1.2 Installation and Setup

Installing and setting up a meteorological tower will vary greatly depending on the location of the tower. Some locations allow a tower to be anchored into the ground, while others do not. For example, if a tower is needed on the roof of a building, anchoring the tower by digging a hole and pouring a concrete base is not possible. Because there are so many installation scenarios, only the most common will be discussed in this document. It is recommended that all installation scenarios be considered before choosing a particular method. These scenarios are described in Sections 1.2.1 through 1.2.3.

In addition to location variations, climate plays a large role in the installation process. For example, in a location that experiences freezing rain, extra support devices may be used to ensure the tower does not collapse due to the extra weight of the ice on the tower.

1.2.1 Ground Installations

Ground installation is intended for free-standing 10-m aluminum triangular towers that will be installed on the earth's surface in an area that does not experience severe/extreme weather conditions. Additional guy wires (wires that extend from the upper portion of the tower to the ground to provide additional support) and a larger concrete footing may be necessary depending on the circumstances of each installation, especially in climates that experience permafrost conditions.

The procedure illustrated in Figure 1.6¹⁰ explains, step by step, how to create a concrete footing, secure the tower base to the footing, erect the tower, and secure the tower using guy wires and other methods. For guidance on choosing a location and siting the tower, see Section 1.4.



<p>Step 1. Dig a 3-ft x 3-ft x 4-ft deep hole. Approximately 1.5 cubic yards of concrete will be needed to fill the hole. Rebar will also be needed for towers greater than 10 m in height.</p> 	<p>Step 2. Place the tower's base into the hole and ensure that all three base legs are lined up so that the tower may be lowered and raised without obstruction. Pour the concrete.</p> 
<p>Step 3. (Perform this step while the concrete is setting up). It is very important to ensure that a triangular fixed tower is plumb. Use the bottom section of the tower to ensure proper positioning of the base by vertically placing a carpenter's level on the leg of the tower. Crank-up towers will require at least three people to perform this step.</p> 	<p>Step 4. Allow sufficient time for the concrete to set up.</p> <p>Step 5. Ensure the tower is completely assembled and attach three guy wires to the guy wire holes on the tower using the hardware included with the tower. If hardware is not included, use an anchor shackle fastener to secure the guy wires to the tower.</p> 

Figure 1.6 Ground Installation Procedure (Steps 1-5)

<p>Step 6. Dig a 1-ft x1-ft x 1-ft hole for each guy wire. Ideally, holes should be approximately 25 ft from the tower's base and should enter the earth at a 45° angle.</p>	<p>Step 8. Erect the tower. Secure the tower to the base. Attach the guy wires to the eyebolts and make any necessary adjustments. It is recommended that two people be present when raising and lowering a tower in a manner prescribed by an agency's health and safety plan (HASP).</p>
<p>Step 7. Pour concrete into the hole and insert a 12-inch eyebolt. Let the concrete set</p> 	

Figure 1.6 Ground Installation Procedure (Steps 6-8)

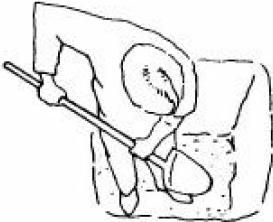
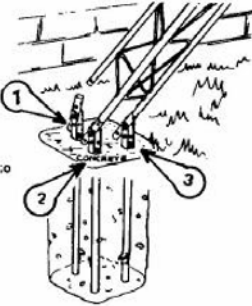
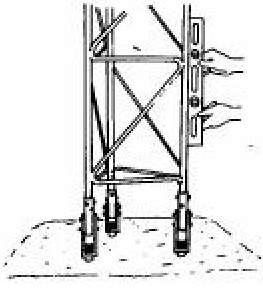
1.2.2 Roof Installations

Roof installation is intended for triangular towers that will be installed on an existing structure in an area that does not experience severe/extreme weather conditions. Roof installations differ from ground installations because there is no earth available to dig a footing. This procedure assumes that penetrating a roof's surface is not permitted. However, if penetration is permitted, fastening the tower directly to the roof of the building will be much easier than creating a non-penetrating base. Additional guy wires and a larger base may be necessary depending on the circumstances of each installation.

The procedure illustrated in Figure 1.7¹⁰ explains, step by step, how to set up a non-penetrating base, secure the tower to the base, erect the tower, and secure the tower using guy wires and other methods. For guidance on choosing a location and siting the tower, see Section 1.4.

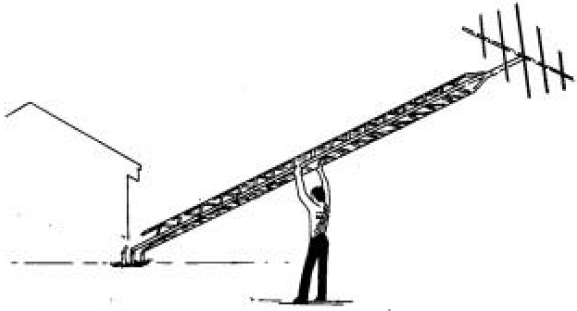
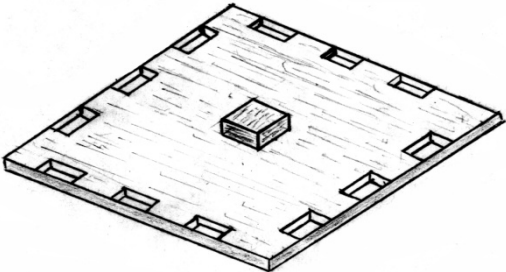
<p>Step 1. Construct or purchase a 10-ft x10-ft support base. The support base should be made of wood or metal. The base should be constructed in a manner that is similar to a freight pallet. However, empty spaces should be left in the pallet to accommodate for sandbag placement. Also, the support base needs to be constructed so that the tower's base can be properly mounted on the top of the support base.</p>	
---	--

Example support base

Figure 1.7 Roof Installation Procedure (Step 1)

Step 2. Use bolts to secure the tower's base to the support base. It is very important that the tower is plumb. For triangular fixed towers, use the bottom section of the tower to ensure proper positioning of the base by vertically placing a carpenter's level on the leg of the tower. Crank-up towers will require at least three people to perform this step.

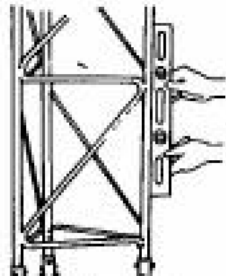

Step 3. Ensure the tower is completely assembled and attach three guy wires to the guy wire holes on the tower using the hardware included with the tower. If hardware is not included, use an anchor shackle fastener to secure the guy wires to the tower. (Note: fewer than three guy wires may be used if the tower is fastened to a nearby structure by other means).



Step 4. Locate nearby structures or retaining walls that are rigid and strong. These structures may be used to host eyebolts for guy wire installation.



Figure 1.7 Roof Installation Procedure (Steps 2-4)

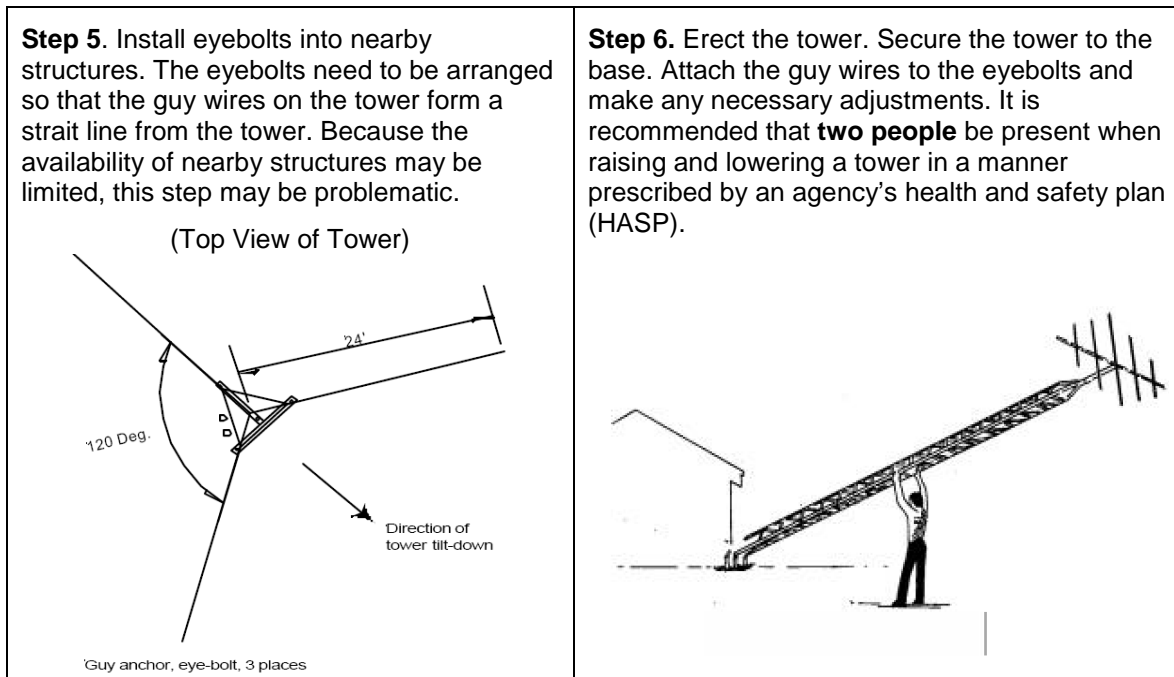

Figure 1.7 Roof Installation Procedure (Steps 5-6)

1.2.3 Other Installations

Every site is unique and installation options will vary. Therefore, it is recommended that a site's layout and available support structures be considered before commencing installation. Some unique installation methods are illustrated in the Figures 1.8 through 1.11 below.

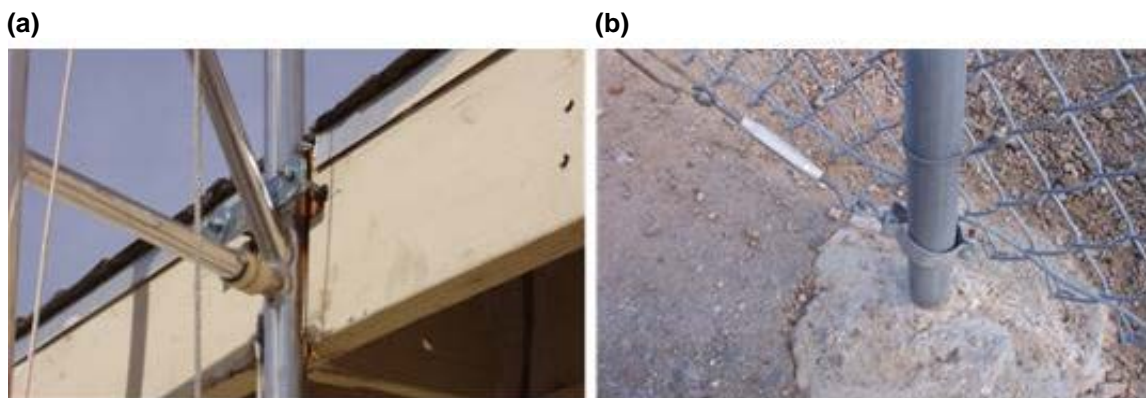

Figure 1.8 (a) Fascia Board Support; (b) Fence Post Guy Wire Anchor



Figure 1.9 (a) Angle Iron Support—Expanded View; (b) Angle Iron Support—Close-Up View



**Figure 1.10 (a) Metal Wall Support—Telescopic Tower (Expanded View);
(b) Metal Wall Support—Telescopic Tower (Close-Up View)**

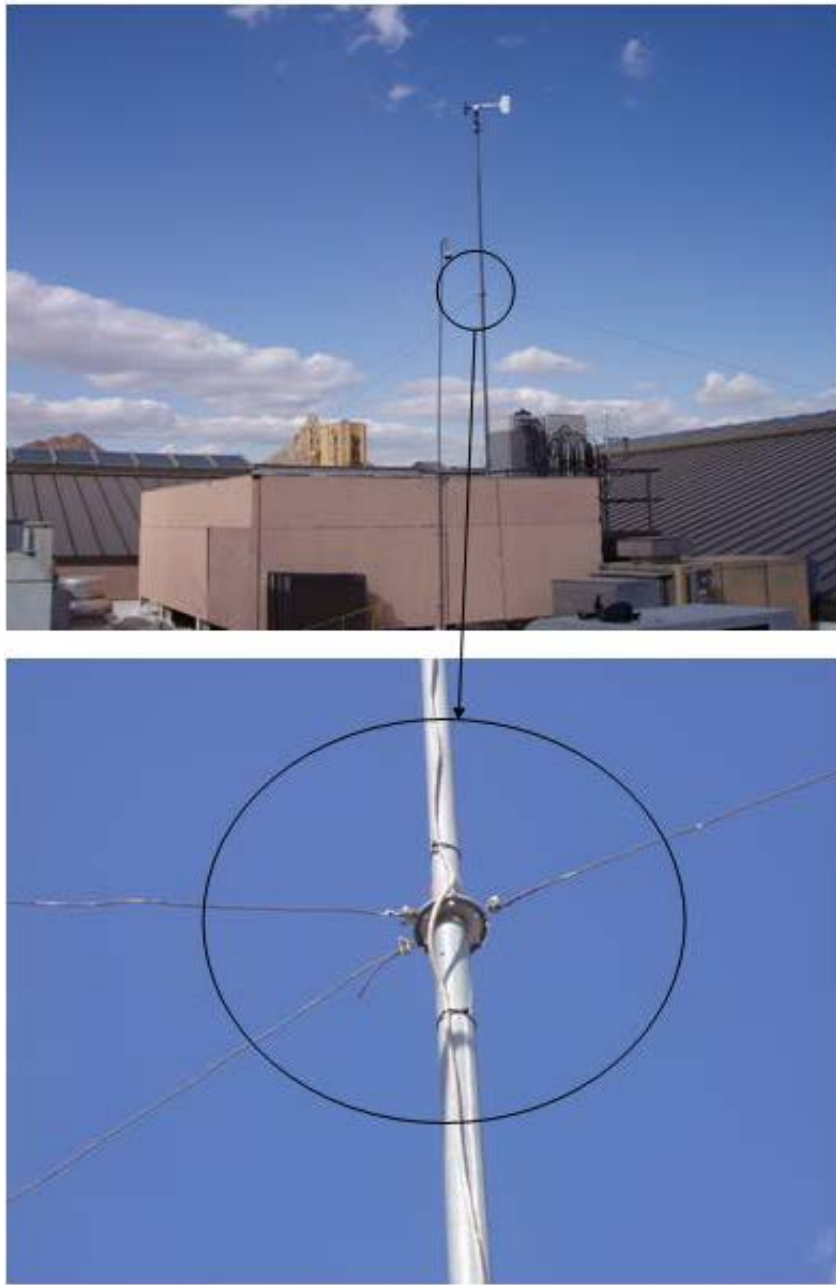

**Figure 1.11 (a) Expanded View Guy Wire Harness—Telescopic Tower;
(b) Close-Up View Guy Wire Harness—Telescopic Tower**

1.2.4 Lightning Protection and Grounding

When tower setup is complete, ground rods and wires must be installed to protect the tower components from damage caused by lightning. The grounding mast mount should be installed on the tower mast above the wind sensor crossarm. For ground installations, soil composition should be considered to determine the most beneficial grounding technique. Additional technical information about lightning grounding specifications can be obtained from the Lightning Protection Institute. (www.lightning.org)

The typical 10-m tower grounding kit consists of the following parts:

- ▶ Ground rod
- ▶ Ground rod clamp
- ▶ Point
- ▶ Railing point bracket
- ▶ Grounding cable—8# copper or 4# aluminum (purchased separately)
- ▶ Horizontal support
- ▶ Mast mount

Whether the tower is installed at ground level or on a roof, the grounding kit components should be installed from the upper part of the tower to base level. The location of the point mast should be taken into consideration so as to not interfere with proper installation and alignment of the wind sensor crossarm. The grounding cable should be attached to the point base and fastened to the tower every 2 to 3 feet to one of the pivoting legs of the tower. Isolating the ground cable on one leg of the tower is advised to reduce the possibility of damage to sensors and signal conditioning equipment in the event of a strike. The grounding rod is driven into the ground at the base of the tower, leaving 3 inches of the rod above ground to which to fasten the rod clamp and cable. For roof installations, the cable should run down the side of the structure from the roof and into the earth's ground (Figure 1.12).

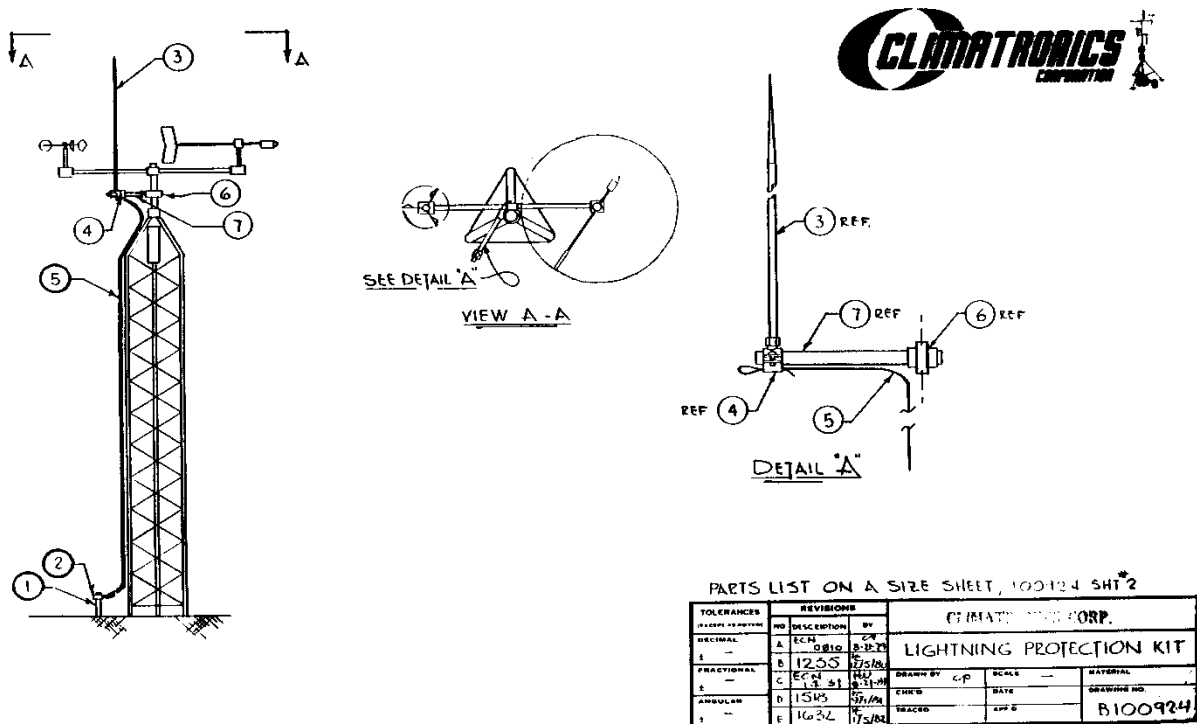

Figure 1.12 Lightning Protection Installation

1.3 Tower Wiring

The tower wiring scheme depends to a large extent on the type of tower and instrumentation. Typically, a meteorological sensor signal cable runs from the sensor to the base of the tower. Outdoor-grade cable ties work well to fasten the signal cables to the tower. Signal cables should be installed, keeping in mind the potential disruption of signal cable placement during instrument audits and maintenance. If a tilt-down tower is used, the signal cable should be secured to one of the pivoting legs of the tower with sufficient slack at the tower base to avoid damaging the cable when the tower is raised or lowered. Some examples of signal cable installations provided in Figures 1.13 and 1.14 show signal cables secured at the base of a tilt-down tower.



Figure 1.13 Signal Cable at Tower Base



Figure 1.14 Temperature Cable Installation and Expanded/Close-Up Views

Triangular adjustable (crank-down) towers require that signal cable(s) be fastened to the guide holes at the end of each section of the tower to avoid damaging the cable when lowering or raising the tower. Figure 1.15 shows the cable guide-hole for an adjustable tower.



Figure 1.15 Wiring on a Crank-Down Tower

1.4 Tower Siting

This section provides guidance on the siting and exposure of meteorological towers and sensors for the in situ measurement of primary meteorological variables.

As a general rule, meteorological sensors should be sited at a distance beyond the influence of obstructions, such as buildings and trees; this distance depends on both the variable to be measured and the type of obstruction. The other general rule is that the measurements should be representative of meteorological conditions in the area of interest. Secondary considerations, such as accessibility and security, must be taken into account, but should not compromise the quality of the data. In addition to routine quality assurance activities, annual site inspections should be made to verify the siting and exposure of the sensors. Approval for a particular site selection should be obtained from the permit granting agency prior to any site preparation activities or installation of any equipment.¹¹

1.4.1 Representativeness

Site selection for tower placement should address the question, “Is the site (are the data) representative?” Representativeness is defined as “the extent to which a set of measurements taken in a space-time domain reflects the actual conditions in the same or different space-time domain taken on a scale appropriate for a specific application”. In general, the location of the tower should be representative of meteorological conditions in the “area of interest”.¹¹

Proper site selection is critical to obtaining representative meteorological data. In order to minimize absolute error, site selection is much more important than proper placement of individual pieces of air monitoring equipment. Poor placement can cause wind direction errors of up to 180° and can cause major errors in any other meteorological variable, including wind speed, temperature, humidity, and solar radiation.

Proper siting is part of a total quality assurance program. Ideal siting may not always be attainable; in fact, in many urban areas where air quality studies are traditionally made, it will be impossible to find a site that meets air quality and meteorological siting criteria. It is incumbent upon an agency gathering data to carefully describe the meteorological siting deficiencies in a site and, if possible, quantify or at least evaluate the probable consequences of the siting deficiencies on the data. Additional information about siting of meteorological sensors in urban areas can be obtained from the WMO, Instruments and Observing Methods, Report No. 81, "Initial Guidance to Obtain Representative Meteorological Observations at Urban Sites".¹²

1.4.2 Meteorological Towers

Meteorological variables are frequently measured at more than one height. Towers are the most advantageous platforms for continuous measurement. Height restrictions can be a factor with 60m towers in areas close to airports.

Towers should be located in an open, level area (see Table 1-2) representative of the area. In terrain with significant topographic features, different levels of the tower may be influenced simultaneously by different meteorological regimes. These guidelines are based on open-area criteria and, in certain situations, meeting these guidelines may be difficult. Such conditions should be documented well.

Table 1-2 Limits on Terrain and Obstacles Near Towers

Distance from Tower (m)	Slope Between (%)	Maximum Obstruction or Vegetation Height (m)
0 – 15	±2	0.3
15 – 30	±3	0.5 – 1.0 (most vegetation <0.3)
30 – 100	±7	3.0
100 – 300	±11	10 x obstruction height (must be less than the distance to obstruction)

Source: TVA 1977

Tower construction should be open grid, similar to that of most television and radio broadcast towers. Enclosed towers, stacks, water storage tanks, grain elevators, cooling towers, and similar structures should not be used. Towers must be rugged enough to be climbed safely to install and service the instruments. Folding or collapsible towers that enable servicing or calibration of instruments at ground level are desirable, but they must be sufficiently rigid to hold the instruments in the proper orientation and altitude during all seasonal weather conditions for that location.

Wind instruments should be mounted above the top of the tower or on booms projecting horizontally out from the tower. If a boom is used, it should support the sensor at a distance equal to twice the maximum diameter (or diagonal) of the tower away from the nearest point on the tower. The boom should project into the direction that provides the least distortion of the most important wind direction. In some cases, "most important" may involve more than one direction based on site-specific meteorological conditions. For example, a boom mounted to the east of a tower will provide the least distortion of northerly or southerly winds. Two sets of instruments at each level may be appropriate, located on opposite sides of the tower. A simple automatic switch can facilitate the choice of which set of data to use. Orientation of the booms should be included in the tower setup documentation.

Temperature sensors

must be mounted on booms to hold them away from the tower, but a boom length equal to the diameter of the tower is sufficient. Temperature sensors should have downward-facing aspirated shields., preferably over grassy surface The booms must be strong enough so that they will not sway or vibrate excessively in strong winds. The best vertical location of temperature sensors on a tower is a point with a minimum number of diagonal cross-members and away from major horizontal cross members. Even with these precautions, data obtained while the wind blows from the sector transected by the tower may not be free from error.

Choosing a good location for tower placement is key to ensuring ease of maintenance. The location should permit unobstructed tower raising and lowering and particularly take into account how protruding meteorological equipment such as a temperature probe may be affected. The location should also allow placement of meteorological equipment at a proper distance from surrounding objects. Triangular towers, for example, may only be raised or lowered in one direction; and this limitation must be considered before installation. Figure 1.16 shows that maintenance considerations were made when a tower was installed. The tower is located so that it can be lowered between the gate opening of a chain-link fence. If the tower had been installed in any other direction, the tower would have rested on the fence and a ladder would have been required to gain access to the top of the tower. Figure 1.17 illustrates the use of Superstrut® metal framing attached to the shelter to support the tower. Using the shelter to support the tower at two heights eliminates guy wires.



Figure 1.16 Example of a Tower Location



Figure 1.17 Example of a Tower Attachment

2. Wind Speed and Direction

2.1 Introduction

Most aspects of the task of monitoring wind at a particular site with an emphasis on quality assurance are discussed in this section. This section includes background information describing the nature of wind and the kinds of instruments commonly used to measure speed and direction. The important aspects of the operation of conventional anemometers and wind vanes are detailed. In addition, a discussion of the emerging use of sonic anemometers is included. The background and detailed information provided are necessary for two kinds of tasks. The first task is to collect valid data representative of the project objectives. The second task is to audit or judge how well the first task was performed within the goals or regulations requiring the measurements.

Section 2.2 on instruments and specifications stresses the understanding of how common sensors work. That understanding is necessary before purchasing, installing and operating instruments. Specifications set the performance standards for an instrument or system. This section provides wind instrument definitions along with test methods that will enable the user to verify or judge the work of others who verify conformance to specifications.

Once the specifications are clearly understood, the process of purchasing and acceptance testing can be considered. Quality assurance is a vital aspect of defining the systems or instruments to be purchased and verifying their performance. Measurement quality objectives (MQOs) play the principal role in determining what system should be purchased. Once the wind system is chosen based on specifications, the installation can be planned and implemented.

Calibration is the foundation of data validity. This important function may be practiced in a number of phases of the monitoring program. Documentation of calibration findings and methodology is vital. The use of inclusive calibration methods in field conditions is recommended. After a calibrated system has been installed, the routine performance of operational checks, preventive and corrective maintenance, and quality control operations begin. The documentation of calibration results, procedures, and field operations provides the framework to support data validity.

Performance audits document the accuracy and precision of a wind system and confirm that quality control procedures have been properly implemented. Comprehensive performance audit methods should be used to challenge the wind system. Recommended audit methods are described in detail in this section.

All the details or background information that might be needed or desired is not included in this section; however, references are listed in Section 11. If the reader needs additional information or is curious about peripheral subjects, the references will provide the answers or a start in search of the answer.

2.2 Types of Instruments and Specifications

Manufacturer's specifications define performance criteria of wind instruments and systems needed to meet project objectives. Procurement specifications ensure that instrumentation will meet data and measurement quality objectives. Performance and procurement specifications provide the basis of inspection and testing when instrumentation is received at a site. Wind speed and wind direction are typically the most important parameters measured, and the specifications of the instrumentation used to measure them are the most complicated.

Project and application requirements vary. To make this handbook as specific as possible, the discussion will concentrate on requirements typically encountered for air quality monitoring, consistent with those presented in the On-Site Meteorological Program Guidance for Regulatory Modeling Applications.¹¹ These specifications in general meet the most demanding goals encountered in air monitoring.

2.2.1 Cup Anemometer and Vane Systems

The cup anemometer has cups that relate the rate of rotation and the wind speed. The cup anemometer's dynamic performance characteristics (starting threshold and distance constant) are density-dependent, but its transfer function (rate of rotation vs. wind speed) is independent of density. The cup is not very efficient and creates turbulence as the air flows through and around it. The cup anemometer is omni-

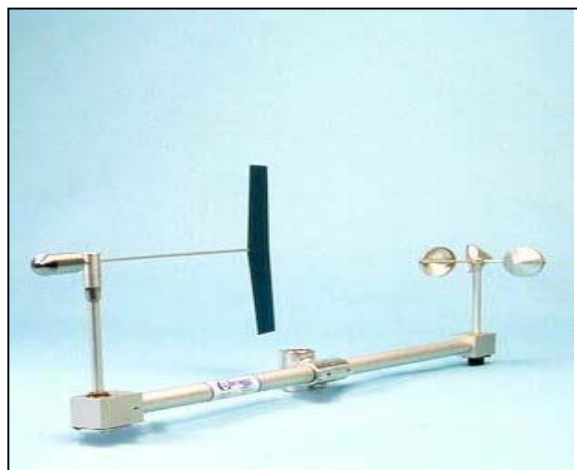

Figure 2.1 Cup and Vane System

directional in a horizontal flow situation but exhibits a complicated reaction to vertical flow situations. It may indicate speed slightly greater than the total speed when the flow is not horizontal.¹³ Figure 2.1¹⁴ illustrates a classic wind cup anemometer and vane system. The wind vane is perhaps the simplest of instruments. A fin is tied to a vertical shaft so that when force is applied to the area by the wind, it will turn the shaft, seeking a minimum force position. The relationship of the shape, size, and distance from the fin's axis of rotation to the bearing assembly and transducer torque recommendations determines the starting threshold. These attributes of the fin area, along with its counterweight, determine the dynamic performance characteristics of overshoot (damping ratio) and delay distance (distance constant) of the direction vane.

Vane design is of little importance if average wind direction is the only recommendation. If turbulence parameters are of interest, the design of the vane becomes important. The vane transducer is usually a potentiometer. It is common that the range of the sensor is 350° rather than the physically true 360°. The reason is related to the problem of a continuous range (a circle) with a discontinuous output (0 to n volts). Knowing how the transducer works is important if the performance of the wind vane will be challenged for QA purposes.

A special direction vane—the bi-vane—has a vertical range of 45 to 60 degrees in addition to the full azimuth circle. The additional range brings with it the need to neutralize gravity by having a perfectly balanced vane assembly. A bi-vane can be conditionally out of balance, which can happen when dew forms and then evaporates from the tail fins. The effect of this imbalance on threshold and performance is complicated. Bi-vanes are rarely used in air monitoring applications and will not be discussed further.

2.2.2 Propeller Anemometer and Vane Systems



The propeller anemometer, Figure 2.2¹⁵, is a more efficient shape. The helicoid propeller is so efficient that its transfer function can be specified from theory.¹⁶ It creates little turbulence because the air flows mostly through it. The propeller measures wind speed when it is oriented into the wind by a vane. Its errors from imperfect alignment with some mean vector are small and are nearly proportional to the cosine of the angle of misalignment.

Figure 2.2 Propeller Anemometer

2.2.3 Sonic Anemometers

Sonic anemometer systems are based on the principle that wind changes the transit time of a sound pulse across a fixed distance. Sonic systems can be designed in two dimensions for horizontal wind speed and direction as a replacement for the cup and vane or propeller units, or in three dimensions for both horizontal and vertical wind measurements. For those applications where the contribution of small eddies is important, sonic systems are an excellent choice. Sonic anemometers are being used in routine air monitoring networks; however, because they are based on newer technology, sonic anemometer systems are not as widespread as conventional systems. Because the measurements are based on a different principle, sonic systems can produce different results, and more comparisons with conventional systems are needed to understand these differences. As with any method in a routine air quality monitoring network, it is critical to perform an audit of a sonic system. Figures 2.3 and 2.4¹⁵ show examples of sonic anemometer systems.



Figure 2.3 2-D Sonic Anemometer



Figure 2.4 3-D Sonic Anemometer

2.3 Acceptance Testing

The instrumentation procurement document, purchase order, or contract should be specific in terms of required performance specifications. “Required” in this context may only mean that an instrument meets the suggested or specified regulatory performance. Beyond the scope of this handbook is whether “necessary” relates to the application for which the data will be used.

There are two kinds of performance specifications: those that can be verified by simple inspection testing and those that require unusual test equipment and experience. The former should be tested and the latter certified by the manufacturer. The manufacturer should have either performed tests on one or more samples of the model design or arranged for such tests to have been conducted by a calibration facility. In either case, a test report should be available for any purpose that requires the documentation.

Acceptance testing procedures for checking sensor threshold, accuracy, distance constant, and overshoot are detailed in the 1995 version of the quality assurance handbook (Volume IV, Section 4.2.3²). Methods for performing acceptance testing are in many ways similar or even identical to those for calibrating the sensors. Thus, the following discussions on acceptance testing only summarize the methods. The section on calibration offers a more detailed discussion of the methods.

2.3.1 Wind Speed

2.3.1.1 Threshold

The key measurement for threshold is starting torque. Starting torque requires knowledge of the K value (cup or propeller aerodynamic shape constant), which should be available from the manufacturer.

2.3.1.2 Accuracy

The acceptance test for accuracy is the conversion of rate of rotation to output in units of wind speed. The transfer function, supplied by the manufacturer, should be in terms of revolutions per minute (rpm) versus wind speed (m/s). The accuracy can be checked by turning the anemometer shaft at a few known rates of rotation to see if the system output compared to the predicted output is within the tolerance specification.

2.3.1.3 Distance Constant

The distance constant determination requires a special wind tunnel test and is beyond normal receiving inspection capability. This information should be provided by your manufacturer.

2.3.2 Wind Direction

2.3.2.1 Threshold

The threshold acceptance test is a starting torque measurement. To relate the torque measured to wind speed and offset angle, a K value is required, either from the manufacturer or from an independent test. The torque measurement may be made with the vane assembly removed or with the vane assembly in place. If the latter is chosen, verticality is essential to negate any out-of-balance in the vane assembly from biasing the test. Also, there must be no air motion. Very small air motions will bias the test. A smoke puff should be used to ensure that the air is still and the inspector should refrain from breathing in the direction of the vane surface.

2.3.2.2 Accuracy

The acceptance inspection is the best time to establish true non-linearity. The test using some circle-dividing fixture capable of fine resolution of one degree should be utilized to provide a record that can be referenced in future field spot-checks. Without such a test, it is difficult to prove wind direction sensor accuracy within three degrees

The acceptance inspection cannot include orientation error with respect to the sensor siting to true north. There may be orientation fixtures, however, that assume that an optical centerline is parallel to the line set by an orientation pin. Field orientation may be based on the orientation of a crossarm with the assumption that the output angle when the vane is parallel to the crossarm is known. This assumption can be tested or the alignment fixture set in laboratory conditions to the desired output.

2.3.2.3 Delay Distance and Overshoot

These dynamic characteristics require a special wind tunnel test and their determination is beyond normal acceptance inspection capability.

2.3.3 Measurement System

All the elements of a system of signal conditioners, recorders, and monitors will require checking for correct function. The receiving inspection should include testing these various sub-systems.

After the calibration inputs have been adjusted and the “output” has shown the system to be in calibration, a parallel analog recorder may show incorrect values. This event could be caused by an incorrect adjustment in the interface that drives the analog recorders from the output.

2.4 Installation, Instrument Exposure, and Wiring

“The standard exposure of wind instruments over level, open terrain is 10 m above the ground”¹⁷; however optimum measurement height may vary according to data needs. Open terrain is defined as an area where the horizontal distance between the instrument and any obstruction is at least 10 times the height of that obstruction. An obstruction may be man-made (e.g., a building) or natural (a tree) (Figure 2.5). A wind instrument should be securely mounted on a mast that will not twist, rotate, or sway. If a wind instrument must be mounted on the roof of a building, it should be mounted high enough to be out of the wake of an obstruction. Roof mounting is not a good practice and should only be resorted to when absolutely necessary. Sensor height and its height above the obstructions, as well as the character of nearby obstructions, should be documented.

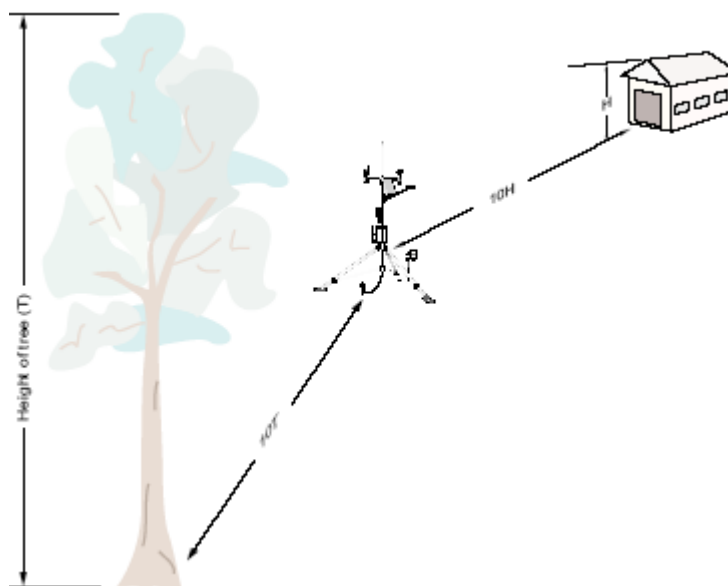

Figure 2.5 Siting Wind Instruments—a 10-m Tower Located at Least 10 Times the Height of Obstructions Away From Those Obstructions (Not to Scale).¹⁸

2.5 Calibration and Alignment

Calibration qualifies as both a measurement and an adjustment, if necessary, of the performance of the wind system and its components. Manufacturers usually include in their manuals the details of all available calibration or adjustment points. The important consideration is how the system works as a whole. Since only parts of a system are adjustable, the relationship of these adjustments to the whole system must be known. This section focuses on documenting calibrations and methods to verify system response to subcomponent adjustments.

Go to the following web links to view videos describing the procedures for calibrating a cup anemometer and vane system, and a propeller anemometer and vane system:

<http://www.epa.gov/ttn/amtic/files/ambient/met/cup-and-vane.wmv>

<http://www.epa.gov/ttn/amtic/files/ambient/met/aerovane.wmv>

2.5.1 Wind Speed Calibration

Wind speed sensor bearings deteriorate, and that deterioration influences the performance of the sensors. While bearing deterioration can typically be identified by “feel”, true torque measurements for data validity are nevertheless required.

Calibration that challenges the entire system, except for the coupling or sensor reaction to wind, compares the rate of rotation of the anemometer shaft to output speed. The rate of rotation is generated by a synchronous or a direct current (DC) motor. The average rate of rotation of the motor must be known to convert the rotation rate to wind speed equivalency. The averaging period of the wind system must be known to challenge the system with a known wind speed equivalency within the averaging time period. It is recommended that the calibration be performed with the sensor installed on the tower.

Accuracy determination depends on both the method used in the challenge and the accuracy of the



Figure 2.6 DC Motor Calibration.

Source: <<http://www.youngusa.com>>

measurement of the input. Figure 2-6 illustrates one method of determining the accuracy of the propeller systems. The first step in calibrating a wind cup or propeller anemometer is to remove the vane or cup. All vane or cup anemometers will have a starting threshold value, which is generally very low, usually around 0.2 to 1.0 m/s. When the vane or cup is removed, the value should be recorded from the DAS. This recording should be checked against vendor specifications for starting threshold. A synchronous or DC battery-operated motor/controller should be attached to the propeller shaft. The motor in the illustration is attached to the propeller shaft by stiff tubing or a vendor-provided coupling. Once the motor is attached to the propeller shaft, the motor is turned on and allowed to spin the shaft. Care should be taken at this step so that the propeller shaft turns at exactly the same speed as the motor. Any drag will produce erroneous readings. Once the motor and controller shows the shaft is spinning at the correct speed, the DAS should be read and compared against the

vendor-specified rpm versus rotation table. Next, the speed of the motor needs to be adjusted. The sensor needs time to adjust to the next calibration point before

recording this value. After the wind speed sensor has been challenged at four to five speeds, the response of the sensor should be compared to the vendor-specified results at that speed. The responses should be within the MQOs that are detailed in Tables 0-1 through 0-9 in Section 0.2 .is manual.

2.5.1.1 Wind Speed Sensor Threshold Testing

Sensor starting threshold is a shaft bearing efficiency measurement only. If the wind speed sensor threshold value is above the vendor-recommended value, the instrument must be disassembled and the shaft bearings replaced. Starting thresholds are measured with a torque watch or a torque disk, with a range of 0.01 to 5.0 gram-centimeter (gm-cm). Figure 2.7 illustrates a torque disk for determining the starting threshold. A torque disk is a simple device that uses gravity to exert torque on the wind speed sensor. The torque disk has a center hole with threaded holes that radiate out from the center. The center hole is used to attach the torque disk to the propeller or cup anemometer shaft. The holes that radiate out from the center are utilized to attach screws of varying weights. First, the sensor is removed from the tower and brought inside a shelter where there are no wind influences. The sensor is placed on a level surface. Figure 2.8 shows the torque disk attached to the propeller shaft.

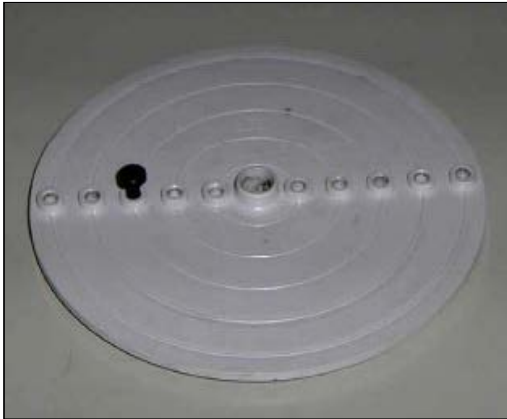

Figure 2.7 Torque Disk



Figure 2.8 Torque Disk in Testing Position

The following steps constitute the procedure to test the starting threshold of a propeller-type wind speed sensor:

- ▶ Place a 1-gm-cm screw in the first hole from the center on the torque disk.
- ▶ Orient the torque disk so that the screw is in a horizontal position.
- ▶ Release the torque disk and observe the response of the propeller shaft.
- ▶ If the screw moves from horizontal, the starting threshold is less than 1 gm-cm.
- ▶ If the screw does not move from horizontal, the starting threshold is greater than 1 gm-cm. The weight is either moved to a hole outward from the center to increase the torque or another weight is added.
- ▶ The procedure is repeated until the torque disk moves from horizontal determining the torque in gm-cm.

The torque formula is converted to provide the starting threshold speed by the following relationship:

$$u = (T / K)^{1/2} \quad (2-1)$$

Where: u = starting threshold
 T = torque (gm-cm)
 K = aerodynamic constant

Starting threshold speed is calculated by using the following equation:

$$T = Ku^2 \quad (2-2)$$

Where: T = torque (gm-cm)
 u^2 = the square of the wind speed
 K = the aerodynamic constant supplied by the manufacturer documentation

The wind speed starting threshold should be less than or equal to the manufacturer's specifications for starting threshold.

The Waters torque watch is often used, Figure 2-9. The torque measurement requires some degree of care and skill. The torque watch has a square shaft which fits into a square hole in the connecting fixture. The torque watch is turned while holding its shaft in line with the anemometer shaft, without end loads. The

indicator is watched; when the anemometer shaft turns, the maximum reading is recorded. This process needs to include at least one full turn of the anemometer to be sure the maximum friction in the bearing assembly is encountered. The torque watch can measure in either clockwise or counterclockwise rotation of the anemometer shaft.



Figure 2-9 Waters Torque Watches: Low-Range 366, Medium Range 651, High Range 940.¹⁹

2.5.2 Wind Direction

2.5.2.1 Orientation

The largest source of error in a wind direction measurement is the wind vane orientation to true north. Orientation error is a fixed bias that can be removed from a data set. The method of wind vane orientation must be capable of 1° accuracy with 2° as the upper limit of the error. Two steps are necessary to achieve wind vane orientation:

- ▶ true north location must be determined accurate to <1 degree, and
- ▶ wind vane “reference position” must be fixed to true north accurate to <2 degrees.

2.5.2.2 Magnetic Declination Methods

The U.S. Geological Survey (USGS) indicates the deviation of magnetic north from true north on its topographic maps. Because the earth’s magnetic field is constantly changing, the magnetic deviation, or declination, is periodically updated when maps are revised, and the year of the applicable declination is shown on each map. Several maps from the USGS site illustrate the magnetic declination lines throughout the United States and North America.

Figure 2.10 illustrates the magnetic declination lines for North America in 2000. Real-time magnetic declination can be obtained using the National Geomagnetism Program from the USGS web site (<http://geomag.usgs.gov/models>). The National Geographic Data Center web site (<http://www.ngdc.noaa.gov/seg/geomag/magfield.shtml>) allows the user to enter the longitude and latitude of a location to determine the actual declination.

The degree of magnetic declination is used to correct a magnetic compass reading to obtain true north. The magnetic compass reading is subject to errors due to aberrations in the local magnetic field. These aberrations could be due to soil types (high ferrous content) or ferrous metal debris buried underground.

Given the correct magnetic declination and the absence of magnetic aberrations, compass readings are often incorrectly adjusted. Figure 2.10 shows that the line of zero declination runs from magnetic north through Lake Superior and across the western panhandle of Florida. Declination can be east, west, or 0°.

from your current position. At 0° declination, true north and magnetic north are aligned. For example, if magnetic declination at your position is 15° east, then magnetic north is 15° east of true, geographic north. Figure 2-11 shows true geographic north and magnetic north. To adjust for east declination, rotate graduated circle clockwise from the zero pin on your compass (Figure 2-12a). For west declination, rotate graduated circle counter-clockwise from the zero pin (Figure 2-12b). Magnetic declination of 0°, no adjustment is necessary (Figure 2-12c).

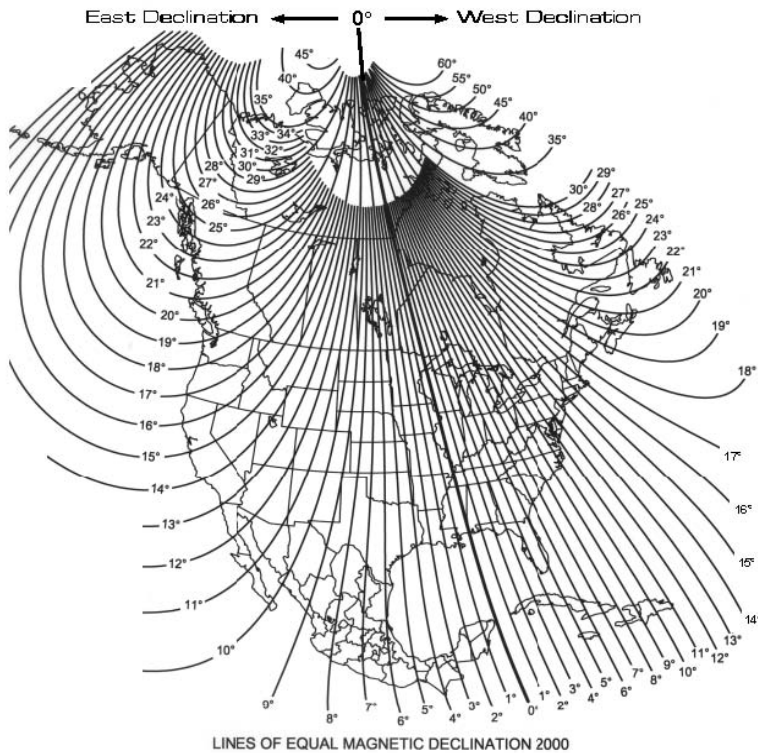

Figure 2.10 Magnetic Declinations for the United States (source: http://geology.isu.edu/geostac/Field_Exercise/topomaps/mag_dec.htm)

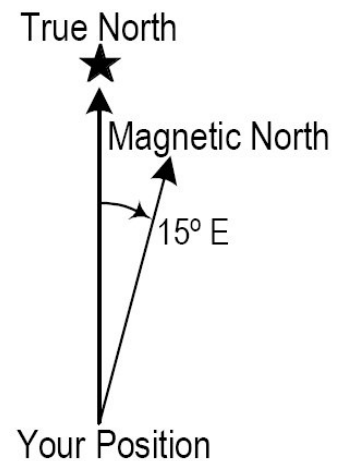

Figure 2.11 True Geographic North and Magnetic North

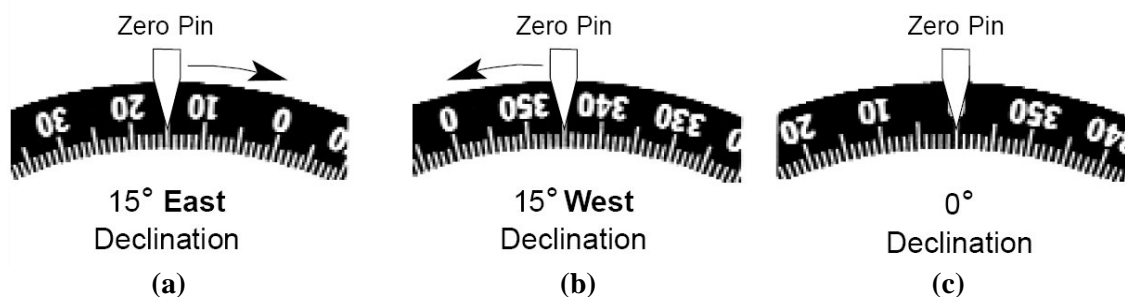

Figure 2.12 Adjusting for (a) East and (b) West Declinations; (c) No Adjustment for Magnetic Declination of 0°

2.5.2.3 Solar Methods

Various solar methods to determine true north are an alternative to using magnetic declination corrections. Solar methods require determination of the exact location of the site and an accurate measure

of the true time and date. The precise location is used to calculate solar angles or to determine the time of solar noon (the time the sun crosses the north/south axis at the location of the tower). A hand-held Global Positioning Systems (GPS) unit should be used to determine the site location with accuracy sufficient to calculate solar angles.

The True Solar Noon (TSN) method uses solar noon time and a theodolite to establish the 180 degree direction from true north. The TSN method produces a 0 degree direction at some latitudes and times of the year. The theodolite base is locked at the true direction the instant the sun is in the cross hair of the theodolite and the time of TSN is reached. This direction provides a reference to true north by which a sensor may be aligned. An alternative method is to mark the end of a shadow that is cast by a vertical tower or pole at the exact time of solar noon.

To simplify the solar method and remove the restriction of having to be at the site at the time of TSN, the azimuth angle of the sun can be calculated at the time the alignment is performed. A BASIC program developed by Blackadar,²⁰ called ALMANAC, provided the ability to calculate the azimuth and elevation angles to the sun, moon, and other celestial objects when the latitude, longitude, year, month, and exact time of day are known. For the 1995 revision to the EPA quality assurance guidance,²¹ Lockhart extracted the subroutines from the Blackadar program that calculated the sun's azimuth, elevation, and solar noon values based on the required inputs. The information from this revised program could then be compared to the magnetic azimuth measurements of the sun to calculate the local magnetic deviation at the point of measurement. Presently, a number of comparable programs can be found on the Internet. The U.S. Navy Observatory web site (<http://aa.usno.navy.mil/data/docs/AltAz.html>) offers a particularly easy program. This web site requests the date, location, and state in order to calculate the solar noon angles in ten-minute increments.

The calculation methodology requires the following equipment:

- ▶ Transit- or tripod-mounted compass, accurate to at least 1 degree. The 1-degree accuracy meets the EPA wind system alignment of 5 degrees
- ▶ Site location in latitude and longitude recorded from a hand-held GPS. An accuracy of about one minute is sufficient as long as the readings are not taken at the time of solar noon with high sun elevation angles.
- ▶ Accurate time standard, correct to the nearest 5 seconds (the handheld GPS provides such a time standard). At the time of solar noon, with high solar angles, the sun's azimuth angle may change rapidly. For example, at an 88-degree elevation angle, the azimuth angle will change 7 degrees per minute of time when low solar angles and times well away from solar noon, the azimuth angle change is slower therefore, time accuracy is not as critical.
- ▶ A program to calculate the sun's azimuth direction at the time of measurement.

The following step-by-step procedure describes the measurement of the alignment of a sensor relative to true north.

STEP 1 – MEASURE THE RELATIVE POINTING DIRECTION

Position a compass or transit to align the cross-hairs through the crossarm or alignment rod of the wind direction sensor. Note the indicated direction of the transit when it is aimed through the crossarm. Independently aligning the transit or compass to a known direction is not important because the crossarm and sun measurements are relative to each other. The measurement is the pointing angle of the alignment crossarm. This angle is called A_{pointing} . Figure 2.13 illustrates a side view of the field setup. Figure 2.14 shows the measurement using a magnetic pocket transit that allows the body to be rotated while the needle continuously points to magnetic north.

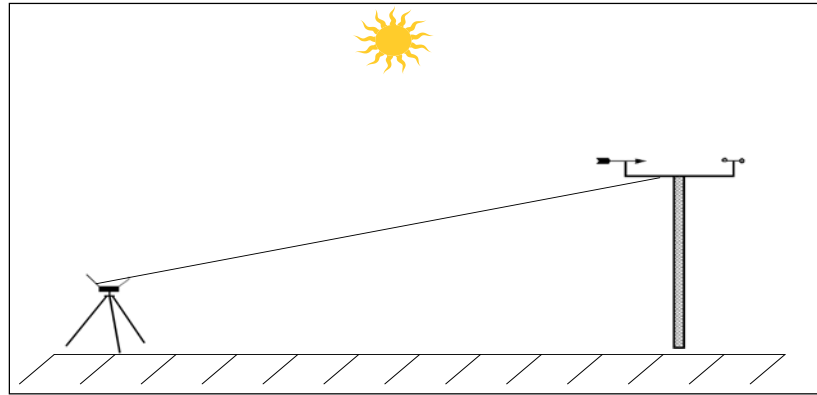

Figure 2.13 Side View of the Placement of a Compass or Transit for Measuring the Crossarm Direction

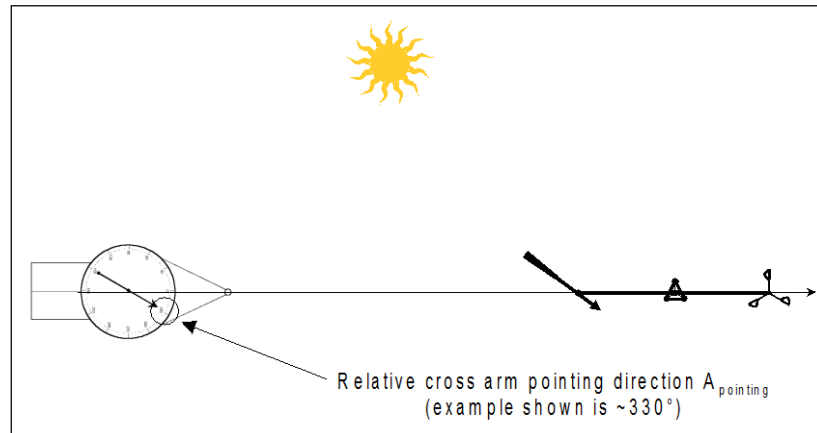

Figure 2.14 Top View Illustrating the Measurement of the Relative Direction of the Crossarm

STEP 2 – MEASURE THE SUN'S RELATIVE AZIMUTH ANGLE

Without physically changing the ground location of the transit or compass, rotate the head to obtain a direct measure of the sun's azimuth angle, as shown in Figure 2.15. Do not look directly into the sun; eye damage may result without suitable protection. If a "pocket transit" such as one made by Brunton is used, the mirror can be set to project the sun and the sighting points and lines on a white piece of paper or other flat object. Figure 2.16 shows the use of the Brunton transit to perform the projection. When the solar azimuth angle is identified, the exact time of the measurement is noted. This time is used to calculate the actual azimuth angle to the sun. The measured angle is called $S_{uncorrected}$.

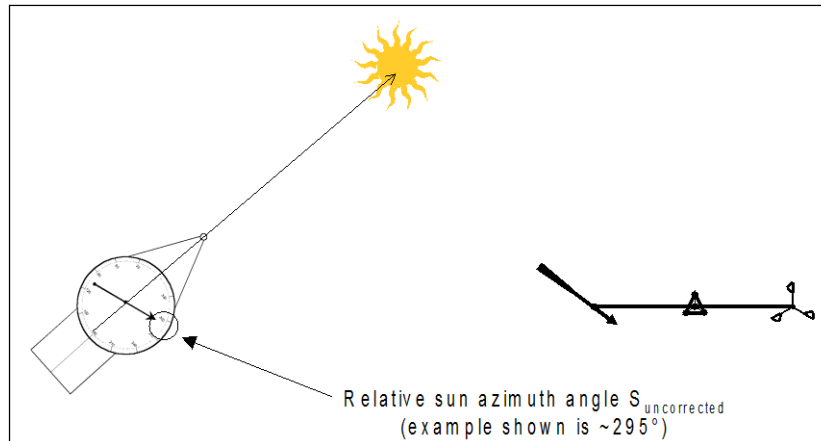

Figure 2.15 Measurement of the Relative Direction of the Sun



Figure 2.16 Projection of Sun's Reflection Using a Brunton Pocket Transit

STEP 3 – CALCULATE THE SUN'S ACTUAL AZIMUTH ANGLE

Using the U.S. Navy Observatory web site²² calculator, calculate the true azimuth angle of the sun at the exact date, time, and location that the reading of sun's azimuth angle was measured ($S_{\text{uncorrected}}$). This angle is called S_{true} .

STEP 4 – CALCULATE THE LOCAL DEVIATION

Calculate the local deviation by subtracting the uncorrected sun angle ($S_{\text{uncorrected}}$) from the true sun angle (S_{true}). This difference is the local deviation (D_{local}) (Equation 2-3):

$$D_{\text{local}} = S_{\text{true}} - S_{\text{uncorrected}} \quad (2-3)$$

STEP 5 – CALCULATE THE CROSSARM TRUE ALIGNMENT

Calculate the true pointing direction (A_{true}) of the sensor crossarm or alignment rod using the uncorrected pointing angle (A_{pointing}) and the calculated local deviation (D_{local}) (Equation 2-4):

$$A_{\text{true}} = A_{\text{pointing}} + D_{\text{local}} \quad (2-4)$$

The calculated pointing direction is now referenced to true north based on the known azimuth angle of the sun.

STEP 6 – ALIGN THE WIND DIRECTION SENSOR

The wind direction vane is positioned parallel with the crossarm referenced to A_{true} . The wind sensor housing is adjusted until the DAS wind direction reading equals A_{true} . The wind sensor housing is locked into position to maintain alignment to true north.

2.5.2.4 Global Positioning System (GPS) Alignment Method

In May 2000, the Department of Defense removed the Selective Availability (SA) encoding on the GPS satellite constellation which increased the position accuracy of 12-channel GPS within 5 m to 10 m. This degree of accuracy of a GPS is capable of measuring the direction of travel, or bearing, over short distances.

The following steps describe the verification procedure of wind sensor alignment using a GPS:

- ▶ Establish a reference point 20 m to 30 m from the crossarm in line with the direction of the crossarm.
- ▶ At the crossarm reference point, turn on the GPS and allow the GPS to obtain a reference waypoint.
- ▶ Walk from the reference point to the ground location directly under the crossarm.
- ▶ The GPS display provides a bearing or direction of travel directly related to the crossarm direction.
- ▶ The procedure is repeated several times in directions toward and away from the crossarm ground location to assure the GPS bearings are consistently 180 degrees from each other.

The accuracy of this method is about ± 1 degree; therefore, the simple solar method could be replaced with an even simpler “walking” method.

2.5.2.5 System Accuracy

The system calibration of a wind vane can be checked on the tower by aiming the vane to and from known directions, such as a distant mountain peak or similar feature. If checks are made with respect to a mounted component, such as a crossarm, the orientation of the crossarm also needs to be checked. A single distant feature should be an orientation target that has a known bearing with respect to true north. Other targets can be secondary checks that challenge both the orientation and the performance of the wind direction transducer. For estimates using the 540 format, the targets should be reached after a clockwise revolution and then again after a counter-clockwise revolution to challenge both parts of the transducer.

Before the wind direction transducer is removed from the tower, documentation of the as-found reading with the vane aligned with the orientation target is essential. This single check provides the basis for data validity for the period beginning with the previous calibration record and ending with the as-found

reading. Wind data validity is based on a data set bracketed between two valid calibration checks. The first calibration check is termed “as left” and the second calibration check is termed “as found”. If the sensor has not been removed from the tower or the orientation adjusted, the “as-left” and “as-found” readings should be the same within ± 2 degrees. If the accuracy of the two checks is not within 2 degrees, data quality is suspect, and further investigation is required to determine the cause and timing of the discrepancy. When the sensor is removed for calibration, replacement in a keyed fixture will cause the “as-left” value to be the same as the “as found”. If there is no keyed fixture, the full orientation procedure will be required to ensure the alignment of the crossarm and wind direction sensor.

A simple orientation procedure requires using a hose clamp to prevent the vane from turning. Tape that does not stretch is marginally useful. Stretchy tape like duct tape or electrician’s tape will only work on a calm day. The vane should be set so that the output is the correct value for the orientation target. If the angle of the orientation target is coincident with an error relative to the average error of 0 degrees, the output should reflect this error. For example, if an error of 2 degrees is noted at the orientation angle, the system reading should be 2 degrees higher than the bearing of the orientation target. Only in this way will the relative error of the sensor be distributed equally for true directions. The clamp should be tightened so the output is both correct and constant. The clamped sensor should be mounted on the tower and turned until the vane points at the orientation target. The vane should be clamped in place. The output should be verified that it is still correct before the vane clamp is removed.

2.5.2.6 Component Accuracy

The same comments about calibration circuits, parallel recorders, and panel meters that apply to wind direction also apply to wind speed, as mentioned in Section 2.5.1 above. With the sensor next to the signal conditioner (attached with either the operating cable or a suitable substitute) and with a fixture that holds known relative directions, the signal conditioner can be adjusted if required. The 540 offset voltage, if one is used, can be tested and adjusted. The output voltage versus position can be set. The open space in the potentiometer, if one is used, can be measured and adjusted for the open spot in the potentiometer.

A single potentiometer has an electrical range of 355 degrees with a mechanical range of 360 degrees. The transfer function of relative direction to voltage output is shown in Equation 2-5.

$$\theta = 360 \times V \quad (2-5)$$

where: θ = angle (degrees)
V = output voltage (0 – 1 V scale)

The maximum “full scale” voltage output, set by shorting the potentiometer wiper to the high side of the potentiometer, is 1.000V (a small error will have been set into the system). The error will be +1.4 percent of the voltage reading; therefore, the potentiometer electrical range of 355 degrees results in a 360 degree DAS response. An electrical range of 180 degrees results in a 182.5 degree DAS response. The adjustment error added to the potentiometer linearity error is not acceptable. If the signal conditioner is set to a voltage output of 0.986V when the vane is set to 355 degrees, the DAS response will be 355 degrees (360×0.986). At 180 degrees, the DAS response is 180 degrees (assuming no linearity error). All the error between 355 degrees and 360 degrees is in the 5 degree sector.²

The starting threshold of the wind vane is important to record accurate directions at low wind speed. The design of the vane along with the offset angle (or error tolerance, typically 10 degrees) provides a K value. The K value along with the starting torque of the vane assembly provides a threshold wind speed using the following equation:

$$\text{Starting Threshold} = (t / K)^{0.5} \quad (2-6)$$

where the starting threshold is in m/s, and the torque (t) is gm-cm.

2.6 Operation and Maintenance

2.6.1 Operations

The important aspects of operations, from the standpoint of quality assurance, are planning and documentation. The purpose of operations is to acquire valid data. For wind measurements, acquisition of valid data requires frequent (weekly, if possible) visual examination of the sensors. This examination is not “hands-on”; it is simply a visual inspection of the active shapes, cups, propellers, and vanes to ensure no physical damage has occurred. Sensitive wind instruments can be damaged by hail and by birds. The nature of an analog recording or plot of collected data, if used routinely, will tell how the sensor is performing. Routine entries in the station log will provide the evidence of attention to support validity claims.

Calibrations are a part of operations. A member of the operating organization needs to become the “expert” on how the measurement system works and what it needs to continue “in control” performance. Regularly scheduled calibrations build the expertise and the documentation showing measurement accuracy. For a new installation, a calibration during the installation is necessary. A careful look at the first week of operation will reveal early failures. If no problems surface, a full calibration at the end of the first quarter is advisable. For some site environments and some applications, quarterly calibrations are recommended. Semi-annual calibration is the minimum frequency. If problems are found, they must be documented and corrected as quickly as possible. The PSD requirement for data collection is 90 percent, this does not permit much down time. The frequency of calibrations or calibration checks is ultimately determined by the performance of the instrument system. If problems occur, more frequent calibrations may be necessary.

2.6.2 Maintenance

2.6.2.1 Routine and Preventive Maintenance

The only routine maintenance required for a wind system should occur during routine calibrations. Sensors exposed to the elements need the application of cleaning and protective lubricants to their mounting hardware. When a sensor needs to be removed for close inspection or calibration and it cannot easily be removed because set screws or nuts are locked to their threads by corrosion, a failure in routine maintenance is probably the reason.

Preventive maintenance must at minimum follow the manufacturer’s recommendations. Considerable damage can result by ignoring this guidance. Sensitive wind sensors require specific care if the threshold is to be maintained.

2.6.2.2 Corrective Maintenance

When a part fails or wears out, a new part usually must come from the manufacturer. The replacement may take a week or two depending on the part and the manufacturer. It is therefore prudent to have spare parts available to cover predictable failures. A component plug-in philosophy is the quickest way to correct failures. If a bearing or a potentiometer fails in a sensor, a new calibrated sensor is simply plugged in while the failed one is repaired.

The next level of spare-part strategy is the sub-component level. Critical and difficult-to-purchase parts should be stocked and used to repair sensors or circuit cards. Conventional sensor parts, typically bearings and direction potentiometers, will always need repair at some point.

2.7 Auditing

2.7.1 General Considerations

A performance audit is the determination of instrument system accuracy made with an independently selected method and by a person who is independent of the operating organization. To make this determination for wind measurements, knowledge of the input conditions imposed on the sensors is required. With knowledge of these input conditions, the transfer functions, and the system's data handling method, the output can be predicted. The difference between the predicted output and the system output is the error of the system or its accuracy.

The methodology starts with ways of controlling and/or measuring input conditions. When controlled inputs are used—as should always be the case for starting thresholds, anemometer rate of rotation versus output, and relative vane position versus output—the accuracy of the output is easily determined. The accuracy of the anemometer transfer function is not a part of this determination. When the input conditions are not controlled, as with the collocated transfer standard (CTS) method, the accuracy determination has a larger uncertainty. The CTS method, however, challenges the anemometer transfer function. The best performance audit uses both methods when appropriate.

2.7.2 Wind Speed (Propeller or Cup Anemometer)

2.7.2.1 Sensor Control

Cup Anemometer

This method compares the transfer function used with the system to the system's output. The anemometer shaft is turned at a known rate of rotation and the output is observed. The means of turning the shaft and metering the rate of rotation are provided by the auditor and are completely independent of the operating system. This method does not challenge the transfer function.

The torque measurement may be used as an indication of the bearing condition and, hence, the starting threshold of the anemometer. The time constant is of use if turbulence is measured.

The following procedure is used.

1. Remove the cup assembly.
2. Mount a coupler to the anemometer shaft. A one-eighth inch shaft is required. If the anemometer does not use that size or it is not accessible, an interface fitting is required.
3. Clamp the drive motor to the support column of the shaft so that the coupler is engaged with the drive wheel. Determine if the cup assembly turns the shaft in a clockwise or counter-clockwise direction, when viewed from above.
4. Operate the drive motor from the transfer function at two speeds within the desired revolutions per minute (rpm). Use a time period synchronous with the system output. An average of one minute or longer is suggested.

This method requires that the system be operating with all cables in place. An rps of zero must be measured (or observed) with the anemometer in place, the cup assembly removed, and the shaft taped to ensure non-rotation.

Fixed Axis Propeller

Similar to the cup anemometer method, the fixed axis propeller method compares the transfer function used with the system to the system's output. A separate form is provided for the vertical component (W) because a different transfer function is often used for this direction than is used for wind speed (U) and output voltage (V). This method causes the propeller shaft to turn at a known rps while the output is observed. The means of turning the shaft and measuring the rate of rotation are provided by the auditor and are completely independent of the operating system. The method does not challenge the transfer function. The designation of clockwise and counter-clockwise is determined by the system being challenged. Differences are calculated by subtracting the audit challenge value from the system output. Arithmetic convention is followed, even though the minus sign is used as an indicator of direction.

The torque measurement may be used as an indication of the bearing condition and, hence, the starting threshold of the propeller. The time constant is of use if turbulence is measured.

The following procedure is used.

1. Remove the propeller.
2. Mount a coupler to the propeller shaft. A one-eighth inch shaft is required. If the propeller does not use that size or it is not accessible, an interface fitting is required.
3. Clamp the drive motor to the support column of the shaft so that the coupler is engaged with the drive wheel.
4. Operate the drive motor in both a clockwise and counter-clockwise direction, when viewed from in front of the propeller.
5. Operate the drive motor at two speeds (find the desired rpm from the transfer function) that are important to the application of the wind speed data. Use a time period synchronous with the system output. An average of one minute or longer is required.

This method requires that the system be operating with all cables in place. An rpm of zero must be measured (or observed) with the propeller shaft in place, the propeller removed, and the shaft taped to ensure non-rotation. Additional observations may be a motor-driven measured rate of rotation at 5 m/s or less to verify accuracy within 0.25 m/s and at least one rate of rotation greater than 5 m/s to verify accuracy of 5% or <2.5 m/s for the operating period of the system to ensure that the signal reaches the signal conditioners when the system is in the operating position.

2.7.2.2 Collocated Transfer System Method

The CTS method for comparing wind speed involves mounting a carefully calibrated anemometer in the vicinity of the subject anemometer being audited. The CTS should have NIST-traceable certificates. If the ASTM International method 10 for comparability is being used, the CTS needs to be within 10 m of the subject anemometer in the horizontal and the lesser of 1 m or H/10, where H is the height above the ground in meters. It is important to site the CTS to be representative of the flow at the subject anemometer. Mutual interference should be minimized through siting and through editing out data where the direction shows the wind-passing through one to reach the other. The accuracy potential of the CTS method is based on data taken in 1982 at the Boulder Atmospheric Observatory (BAO) and published by Finkelstein et al.² and Lockhart.²³

The result of the CTS audit is the difference in speed calculated by subtracting the CTS speed from the subject speed. This method requires a sufficient number of simultaneous and independent differences. A detailed discussion of the required sample number size is provided in ASTM International.²⁴ The optimum duration of a CTS audit is 24 hours (one diurnal cycle).

The CTS method provides a measure of accuracy that can be related to wind tunnel tests. Some field audit devices that claim this capability must be used with caution;²⁵ however, the CTS method does not provide a measure of starting threshold. It is possible to get threshold data from a CTS audit if the CTS have a low threshold of 0.5 m/s, and if samples from the CTS sensors are found with periods in the 0.6 m/s to 1.6 m/s range.

2.7.3 Wind Direction (Vane)

2.7.3.1 Sensor Control

The performance audit of a wind direction vane begins by determining the “as-found” orientation value.

1. Align the vane with the distant orientation target.
2. Use field glasses or a theodolite to confirm the alignment of the vane with the orientation target.
3. Hold or clamp the vane until a constant output exists for a few minutes.
4. Record this value.

A wind vane’s controlled condition is its position relative to the sensor housing. Several ways exist to impose a series of known relative positions on the vane-sensor combination, however, their accuracy varies. It is critical to know the time constant of the direction circuit before starting the performance audit. Set the vane to a known direction, simulate a wind from 90 degrees, and hold the vane until the 90-degree (or voltage equivalent) output is steady. Then, move the vane quickly (< 1 s) to 270 degrees and measure the time constant of the system. Assume that a time constant of 3 s is measured. Table 2-1 shows the change in output angle and voltage (assuming a 540-degree format and 5V output) as a function of time.

Table 2-1 Time Constant Effects

Time Constant (no.)	Time Angle (sec.)	Vane Angle (deg.)	Output			
			Angle (deg.)	Error (deg.)	(540@5) (volts)	Change (%)
0	0	090	090	0	0.833	0.0
0.2	0.5	270	106	164	0.981	9.0
1	3	270	204	66	1.889	63.2
2.3	6.9	270	252	18	2.333	90.0
3	9	270	261	9	2.417	95.0
4.6	13.8	270	268	2	2.483	99.0
6.9	20.7	270	270	0	2.498	99.9

Notice that in this example, a 150-degree shift requires waiting 20 seconds for the reading to be representative of the new position. If a 90-degree shift is used, then 14 seconds will provide an output within 1 degree of the final value. If time constants are greater than the known constant of the direction circuit, the operator should contact the manufacturer to discuss options to modify the circuit to a measuring time suitable for 60 Hertz noise filtering.

The least accurate method for challenging the relative position accuracy of a wind vane is to point the vane in various directions while it is still mounted on the tower. This can provide positions related to external objects rather than constant angle changes. It is estimated that the accuracy of this method is two to five degrees, with the exception of a parallel alignment. The tail vane can be located parallel to a crossarm to within one degree and held parallel on a calm day.

Another recommended method is to have the operating sensor be placed in an environmentally controlled room at the center of a template with radial lines every 60 degrees. With the sensor oriented to the template, the vane is moved and clamped when it is parallel to the radial line. Care should be taken to avoid parallax errors (i.e., non-parallel or non-perpendicular observations). The relative accuracy of this method is on the order of 1 degree.



Figure 2.17 Linearity Test Fixture

A third method for challenging the relative position accuracy of a wind vane replaces the vane with a fixture capable of holding the shaft in position with respect to the sensor housing. Fixtures of this type can provide repeatable position accuracy within 0.1 degree. A different application of this precise method uses a theodolite base as the mount for the sensor. With the vane or vane restitute held in one position, the base is rotated in very accurate steps. Theodolite worm gear assemblies divide a circle in whole degrees and have vernier adjustments with 0.1 degree index marks far enough apart to allow easy interpolation to zero degrees.

Figure 2.17¹⁴ shows a linearity test fixture that accomplished the audit procedures described above with a repeatable position accuracy of one degree.

The audit report form² should contain the transfer function used to convert output voltage to azimuth degrees. This may include a 540-degree format where azimuth values greater than 360 degrees are reduced by subtracting 360. The report form should also contain the challenge regression used by the selected wind vane audit method.

The bearing to the orientation target should be independently challenged with a method capable of better-than-compass accuracy. A theodolite is ideal for finding the bearing to other distant objects.

The last activity of the sensor control audit is to repeat the orientation test described above for the as-found value. The as-left value will represent any changes the operator may have made and the new orientation if the sensor was not keyed for orientation.

2.7.3.2 CTS Method

There is no technical need for a CTS audit of wind direction. No new information is added by this method to that gained in the sensor control method.²

2.7.4 Sonic Anemometers

2.7.4.1 Sensor Control

Using a sensor control method to audit sonic anemometers in the field achieves little. To verify a response of zero, the few control options available include placing a box over the anemometer or in some other way keeping the sensors from observing any air movement.

2.7.4.2 CTS Method

For audits of sonic anemometer systems, some discussion is provided here, but field implementation of these techniques is very limited. Additionally, there are standards for testing and evaluation of the performance of sonic systems,²⁶ but the methods described would not be practical for field implementation. However, these methods have been adapted for field audits and implemented in a routine air quality monitoring network in a cost-effective and timely manner.²⁷ The focus of these demonstration audits was on the variables of wind speed and wind direction from the sonic anemometer; however, other variables (temperature, relative humidity, pressure, solar radiation, and UV radiation) were handled as well.

For the CTS demonstration audit, the objective is to directly compare a collocated mechanical sensor (such as a cup/vane or aerovane anemometer) with a sonic sensor system and evaluate the results against standard criteria. The following section discusses field tests performed by Baxter et al.²⁷

To allow rapid deployment and retrieval of the audit package in the field, the sensor wiring of a data logger is converted from the screw type panel mount to a standard 25-pin connector used for computers. The required channels on the data logger were assigned specific pins in the connecting cable and a seven-connector junction box was used as the main connector interface for multiple sensors. All numbered pins in the junction box were wired in parallel, which allowed a sensor to be plugged into any of the seven connectors and be operational. The assignments of power, ground, excitation, and signal lines were performed in the wiring of the pins in the cable for the individual sensors. The length of the main cable connection between the data logger and the interface was kept short to minimize electrical noise and ground loop problems associated with the distances from common ground connections.

Prior to the start of the demonstration audit program, the mechanical audit wind system was collocated with an RM Young Model 81000 sonic anemometer. Data were collected over a 72-hr period and 5-min horizontal scalar and vector averages of wind speed and wind direction were compared. The sensors were approximately 4 meters above roof height and 1 meter apart, making the sampling height less than ideal. Figure 2.18 shows the sensor mounting. Scatter plots for the scalar wind speed and unit vector wind direction data sets for wind speeds greater than 1.0 ms^{-1} , as measured on the mechanical sensor, are shown in Figures 2.19 and 2.20, respectively. The wind speed plot showed excellent agreement between

the sensors; the sonic anemometer averaged wind speeds 0.04 ms^{-1} higher than the mechanical sensor. The standard deviation of the differences was 0.07 ms^{-1} . Wind direction differences averaged 6 degrees with a standard deviation of 7 degrees. These results were higher than what is recommended by Lockhart;²³ he indicates that the standard deviation of the differences for good agreement should be better than 2 degrees. It is suspected that two factors caused this higher difference: the shorter time duration (5 minutes versus Lockhart's 20 minutes) and the less-than-ideal siting, which would induce more turbulence over the rooftop. It should also be noted that a regression of the measurement pairs for wind direction was not done because there were no wind directions less than 135 degrees observed on the mechanical sensor. Another comparison of mechanical and sonic sensor systems was reported by Robertson and Katz²⁸; their results were similar to those given by Baxter et al.²⁷—for 15-minute averages, the wind speed and direction results did not quite meet Lockhart's criteria.²³



Figure 2.18 Sensor Mounting for the Testing and Evaluation of the Audit Wind Sensor Against a Sonic Anemometer

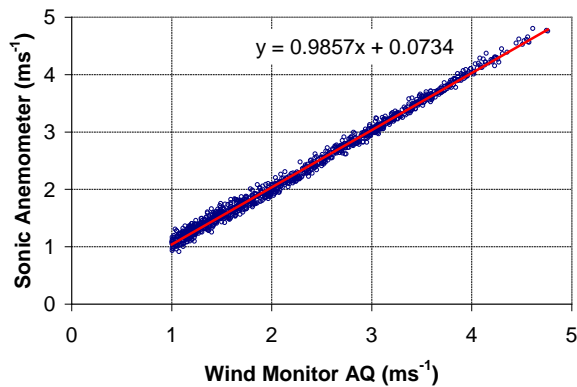

Figure 2.19 Wind Speed Plot Showing the Mechanical Sensor (AQ) vs. the Sonic Anemometer for Wind Speeds Greater Than 1 ms^{-1}

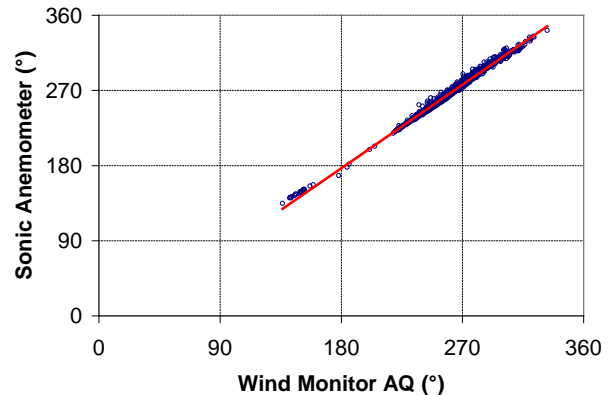

Figure 2.20 Wind Direction Plot Showing the Mechanical Sensor (AQ) vs. the Sonic Anemometer for Wind Speed Greater Than 1 ms^{-1}

Even with the observed differences above, the CTS method was to be used to audit multiple sonic systems in an air quality network. Based on the results of the available intercomparisons, proposed criteria for evaluation of the sonic sensors were developed; they are shown in Table 2-2. These criteria should be modified as more audit and comparison data from systems installed in air quality networks are collected.

Table 2-2 Proposed Audit Criteria for the Sonic Systems

Wind Variable	Average Difference	Standard Deviation of the Differences	Qualifications
Speed	$\pm 0.25 \text{ ms}^{-1} < 5 \text{ ms}^{-1}$ or $\pm 5\%$ or $< 2.5 \text{ ms}^{-1}$ above 5 ms^{-1}	0.2 ms^{-1}	Wind speeds greater than 1 ms^{-1}
Direction	$\pm 5^\circ$	2°	Wind speeds greater than 1 ms^{-1}

Recommended procedures for the CTS audit of sonic anemometer systems are as follows.

1. The site sonic anemometer systems should not be removed from the mounting tower during the audit process and all checks should be conducted with the sensors in place.
2. Assuming the towers have movable carriages, then the entire crossarm and mounting assembly can be lowered from the measurement height to the surface. Before lowering the sensor, its orientation relative to true north should be measured using either a solar method or alignment walked off using a hand-held GPS receiver. These methods are described in Sections 2.5.2.3 and 2.5.2.4. Figure 2.21 shows a typical mounting of the audit system on the carriage structure.
3. The wind sensor should be placed on one end of the audit boom while the temperature/relative humidity sensor should be placed on the other end adjacent to the site sensors.



Figure 2.21 Typical Mounting of the Audit Sensors on the Site Tower

4. A zero point with no wind flow around the sensor can be established using a simple box lined with “egg-crate” type foam to absorb acoustic signals. This type of enclosure is a simple version of what is recommended in ASTM International (2001).²⁶ To seal the box, additional foam can be placed in the opening around the bottom and around the mounting mast. The response of the sensor can then be observed over 5- to 10-minute periods and the wind speed and direction can be noted.
5. A collocated mechanical sensor can then be attached to the carriage on a separate cross-arm with the south-facing direction of the sensor aligned with the cross-arm. Once mounted and raised to

the normal measurement height, the cross-arm direction can be measured and that direction used for the adjustment of the collected wind direction data to a true north alignment.

These procedures would allow field audits to be conducted on multiple stations over a several-day period. To aid in the efficiency of the audits, the audits should be performed for two days: this allows night-time meteorological data to be collected, providing a larger comparison database before it is moved to the next site.

2.8 Scalar, Vector and Sigma Calculations

2.8.1 Discussion of Calculation Methods

There are a number of commercially available data loggers that collect, process, and store wind speed and wind direction information. Wind direction data have traditionally provided a challenge to those who want to define an average of the circular function. The EPA has provided guidance for calculating wind direction in regulatory driven and other monitoring programs. These procedures have been incorporated in one form or another into the available data loggers as standard calculation algorithms. Since the release of the guidance in 1987, the scalar calculation has generally been accepted as a good estimate of the average wind direction. However, experiences gained in using data collection systems implementing both the original EPA scalar average calculation and the unit vector method has raised questions about the validity of the scalar method.

To illustrate the problem with the original algorithm, and to better understand the behavior of it, a model was developed to generate test wind data and perform the wind direction calculations. One-second values comprising the test data were generated by specifying various characteristics about the desired data. These characteristics included the starting direction, the maximum direction swing during the hour, and the maximum rate of change from point to point. A random number generator was then used to create values that fit within the criteria. After the data set was generated, a specified number of 360-degree rotations were added to the set using rotation criteria such as direction and rate. Each of the generated data sets was then saved to a file for analysis by the wind direction calculation algorithms.

Following the creation of the hourly wind data sets, each set was read by the model and average wind directions were calculated. The simple average wind direction was calculated using

$$A_{arith} = \frac{1}{N} \sum_{i=1}^N A_i \quad (2-7)$$

where A_{arith} is the simple arithmetic average, A_i is the azimuth angle of the wind vane for the i^{th} sample, and N is the number of samples used (3,600).

The scalar wind direction AS was calculated using the EPA algorithm

$$AS = \frac{1}{N} \sum_{i=1}^N D_i \quad (2-8)$$

where:

$$\begin{aligned}
D_i &= A_i; && \text{for } i = 1 \\
D_i &= D_{i-1} + \delta_i + 360; && \text{for } \delta_i < -180 \text{ and } i > 1 \\
D_i &= D_{i-1} + \delta_i; && \text{for } |\delta_i| < 180 \text{ and } i > 1 \\
D_i &= D_{i-1} + \delta_i - 360; && \text{for } \delta_i > 180 \text{ and } i > 1 \\
\delta_i &= A_i - D_{i-1}; && \text{for } i > 1
\end{aligned}$$

A_i is the azimuth angle of the wind vane for the i^{th} sample.

D_i is undefined for $\delta_i=180$ and $i>1$.

The unit vector wind direction was calculated using

$$A_{uv} = 90 - \tan^{-1} \left(\frac{\bar{v}}{\bar{u}} \right) \quad (2-9)$$

where:

$$\bar{v} = \frac{1}{N} \sum_{i=1}^N \sin(A_i) \quad (2-10)$$

$$\bar{u} = \frac{1}{N} \sum_{i=1}^N \cos(A_i) \quad (2-11)$$

A_{uv} is the resultant unit vector direction angle in meteorological coordinates. Values less than zero are corrected by adding 360 degrees. \bar{v} is the average v component (north/south) of the unit vector wind and \bar{u} is the average u component (east/west) of the unit vector wind. A_i is the wind direction azimuth angle in degrees for sample i . For each of the test data sets the number of samples (N) was 3,600.

The simplest of the model test runs was to look at the calculations when no rotations were present. Multiple runs were made varying the allowance for rate of change, swings through north, and maximum swing during the 3,600-sample period. In each case, both the scalar and unit vector algorithms produced comparable results.

Then, one 360-degree rotation was injected in the middle of the profile. Figure 2.22 shows a generated profile with the individual calculations from each of the wind direction algorithms. As shown in the figure, the scalar calculation produced erroneous results for the data set while the unit vector produced a reasonable average. The general agreement with the simple average was due to the selected range of values with no crossover in the north direction.

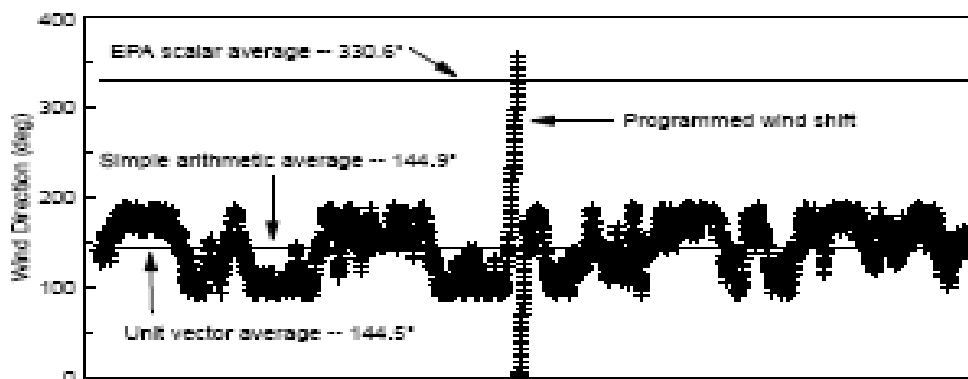

Figure 2.22 Calculated Wind Direction Averages from a Simulated 3,600-Sample Data Set

To evaluate why such significant differences occur between the scalar and unit vector methods, one needs to recognize that the scalar calculation adjusts the wind direction values in a manner to account for the 360-degree circular function. If the difference between successive values is greater than ± 180 degrees, then 360 degrees are added or subtracted to bring the result to the closest rotational direction. If a full 360-degree rotation is experienced with the rotation rate less than 180 degrees per increment, then values outside ± 360 degrees can exist in multiples of 360. During this rotation adjustment process, it is possible for equivalent directions with numerical values in multiples of 360 to be present in the same data set. When the final data set is averaged, these multiples then produce erroneous results. Furthermore, depending on when the shifts occur during the averaging period, the resulting effect can show erroneous results up to 180 degrees from a correctly interpreted average wind direction.

Based on the above discussion, a unit-vector algorithm should be used for calculating scalar wind speed and wind direction.

2.8.2 Stability Classes

Standard deviation (i.e., sigma values, result from how the samples are combined to estimate the statistical parameters. To audit these values, a determination of how the algorithm works and a method to challenge that process with a known input is required. This is also a functional way to document the impact of the signal conditioning time constant on the measurement of direction variability.

The challenge to the process should be realistic or at least within some realistic range. It must take into consideration the wave shape of the variable direction imposed on the system when calculating the true sigma value with which the output will be compared. The effective time constant of the direction system, calculated from the delay distance of the sensor and nominal wind speed important to air pollution applications, should define the maximum frequency used in the sigma challenge.

Wind Vane

The relative performance of the wind vane shaft position transducer is determined with a linearity test fixture, part of which is mounted to the transducer body and part of which is mounted to the shaft in place of the vane.

The following procedures are used.

1. Remove the wind vane assembly (vane, shaft, and counterweight). A one-eighth inch shaft is required to mount the linearity calibration disc to the sensor. If the sensor shaft is not one-eighth inches, an interface fitting is required.
2. Mount the linearity calibration disc on the vertical shaft of the sensor.
3. Mount the clamp to the support column for the shaft so that the pin engages the disc and the disc is free to move when the pin is withdrawn. Figure 2.18 shows a sensor mounted on a linearity fixture.
4. Set the fixture parts with the pin in the 180-degree slot.
5. Rotate the clamp until the sensor output indicates 180, either by equivalent voltage or digital printout. This is a position measurement; the challenge is constant and instantaneous values may be used. However, the time constant needed for stable readings must be taken into account.
6. Rotate the disc to the following positions taking data at each degree marking: 120, 60, 360, 300, 240, 180, 120, 180, 240, 300, 360, 60, 120, 180, and 240. This rotates the sensor shaft 420 degrees counter-clockwise and then 480 degrees clockwise to test '540' strategies for the angle discontinuity.

2.9 Estimating Accuracy and Precision

Appendix A.4 of 40 CFR 58²⁹ contains equations and methods for estimating precision, and bias. These calculations can be utilized to understand the precision and bias of wind speed and wind direction. These equations can be applied to situation where one of the systems is considered the “primary” sampler, such as a cup/vane anemometer system. This section of 40 CFR 58 also has equations for collocated instruments where the operator does not have a “primary” sampling device.

2.9.1 Summarized Data

Appendix 1 contains a meteorological systems audit evaluation form to be used as a guideline to evaluate the operation and exposure of meteorological sensors and overall condition of a monitoring site.

Summarization schemes are many and preclude a full discussion here. The auditor should define the methods used and comment on the appropriateness of the methods in regards to the summarized data. There may be concurrent summarizations such as a scalar wind speed, a vector wind speed, and summarized wind direction. The accuracy of the data system should reflect estimated errors in case of an inappropriate summarization program.

3. Temperature and Temperature Gradient

Air temperature measurements are one of the simplest meteorological measurements, but accurate and representative measurements of air temperature require no less attention to quality than others. Temperature gradient measurements between two levels above ground on a tower demand greater accuracy and precision than measurements of temperature alone. Temperature gradient is commonly known as delta-temperature and is abbreviated ΔT .

High-quality, economical sensors based on electrical resistance that changes with temperature are readily available and adaptable to many data recording and display systems. The challenge is to place the sensors in suitable locations and provide proper protection from moisture, wind, and radiation energy interferences. ASTM International Standard Practice³⁰ for atmospheric temperature measurements describes the types of shields needed to properly protect electrical sensors. Naturally ventilated shields can provide adequate protection for many simple air temperature measurements, but the additional accuracy required for ΔT measurement necessitates using mechanically aspirated shields to provide uniform airflow across the sensor in the shield.

3.1 Types of Instruments and Specifications

The most popular method of air temperature measurement is using devices whose resistance changes with temperature—resistance temperature detectors (RTD), also known as Thermistor, or thermal resistors. Thermistors and platinum wires are readily included in resistance bridges that allow acceptably linear and accurate voltage measurement directly by modern data acquisition system (DAS) or temperature-indicating instruments. Thermistors are often incorporated into standard portable instruments that are used to check the operation of air temperature measuring devices used in the field setting.



Thermistors are electronic semiconductors made from certain metallic oxides, such as nickel, manganese, iron, cobalt, copper, magnesium, titanium and other metals. Individual thermistor beads have non-linear properties relating temperature and resistance, but suitable combinations of beads can provide an adequately linear response. Platinum wire properties relating temperature and resistance (Figure 3.1) are considerably more linear than thermistors. Typical thermistors used in meteorological measurements are in the range of thousands of ohms range, compared to the platinum wires being in hundreds of ohms. This difference makes the electrical resistance in the cable connections from the sensor to the measurement point more sensitive for platinum wires than for thermistors.

Figure 3.1 Example of a Platinum Wire

Thermistor.

Source: <<http://www.climatronics.com/>>

In years before the routine use of RTD sensors, glass thermometers containing liquid were the standard instrument for air temperature measurements. Glass thermometers are still useful tools for testing RTD sensors, though the need for at least partial immersion in the medium containing the test RTD device and the fragility of the glass thermometers make them difficult to use in a field environment. More information about glass thermometers is available from ASTM International.³¹

The easy availability of reasonably priced on-site digital signal processing makes separate analog signal conditioning of temperature signals unnecessary. However, RTD sensors are components of bridge circuits that include fixed resistors and an excitation voltage to produce a measurable voltage signal. Equipment and system vendors are the best source of proper wiring and signal processing information.

The required system accuracy for air temperature measurements described in EPA monitoring guidance³² is ± 0.5 degrees C as described in most EPA guidance. . Hence, the reasonable accuracy expected from the air temperature sensor is ± 0.3 degrees C. The temperature range over which this accuracy applies depends on the location and purpose of the measurements. Typical systems can meet this recommendation from -30 to +50 degrees C, which is ample for many locations.

Sensors used for ΔT measurements should have at least the same absolute accuracy, with two temperature sensors having a relative accuracy across the working range of the instruments of less than ± 0.1 degrees C. Suitable pairing of thermistors with the same non-linear characteristics can provide the more rigorous relative accuracy needed for that measurement.

The exposed temperature sensors and related equipment must be able to operate throughout the expected range of temperatures encountered at a site, including likely extreme values. In addition, ancillary equipment and related signal processing or recording equipment must be capable of operating in the range of temperatures corresponding to their location, such as in an instrument box or in a climate-controlled structure.

When specifying cable length and the accessibility of the sensors, keep in mind that field QC procedures require removal of the sensor from the shield and its placement in a temperature bath while still connected in its normal configuration.

3.2 Acceptance Testing

New equipment or equipment that is returned from maintenance or calibration by vendors located elsewhere should be checked for proper operation. Damage that could affect response can occur in shipping and handling. Simple checks for reasonable responses can be an adequate initial acceptance test; precautions identified in the formal field QC procedures (Section 3.4) should be observed when testing. A formal check is recommended during installation at the operating site.

3.3 Installation and Wiring

Temperature sensors should be mounted over a plot of open level ground at least 9 m in diameter. The ground surface should be covered with non-irrigated or un-watered short grass or, in areas where grass does not grow, natural earth. Gravel surfaces are also acceptable. The surface must not be concrete or asphalt or oil-soaked. The standard height for climatological purposes is 1.25 m to 2 m, but different heights may frequently be required in air quality studies. For general purposes, the primary temperature

sensor is mounted 2 m above ground level, with the inlet facing away, and at a distance of approximately 1.5 times the tower diameter, from the tower.

The sensors should not be closer to obstructions, such as trees and buildings, than a distance equal to four times their height. They should be at least 30 m from large paved areas and not close to steep slopes, ridges, or hollows. Areas of standing water should also be avoided. Louvered instrument shelters should be oriented so that the door opens toward true north in the northern hemisphere. Motor-aspirated shields should also be oriented with the sensors toward true north in the northern hemisphere.

Proper planning will assure that the mounting hardware, cables, power supply, and so forth are all compatible and available. Planning also assures that an installation will proceed without difficulty. Purchasing equipment through a vendor who provides everything the system needs to readily attach cables can save considerable technical time and effort of having to fabricate mounting hardware and prepare cables. Additional lightning protection should be considered in areas where lightning occurs.

Most temperature sensors do not require additional power beyond the excitation voltages in the bridge circuit, though motor-aspirated temperature shields require electrical power. Figures 3.2 and 3.3 are examples of naturally ventilated and motor-aspirated shields. Ambient temperature sensors must be shielded, otherwise, solar radiation will cause errors in readings. Shields can be powered by direct current (DC) fans operating on batteries recharged by solar panels or an alternating current (AC) trickle charging unit. Operating the system on DC, even when AC power is available, can reduce missing data periods when electrical power is unavailable.



Figure 3.2 A Naturally Ventilated Shield.
Source: <<http://www.youngusa.com/>>



Figure 3.3 A Motor-Aspirated Shield. Source:
<<http://www.metone.com/>>

A complete quality assurance plan will prescribe appropriate installation and testing procedures. These procedures are developed from manufacturer's specifications and guidance and instrument exposure recommendations listed in monitoring guidance documents.

3.4 Calibration

Calibrating a temperature measurement system consists of comparing the output of the device being calibrated to a known value, and determining if the difference is within acceptable tolerance limits. Most modern temperature measuring systems do not need adjusting to match known values if all components are working properly, so acceptance is pass or fail. Improper signal cable connections or signal processing instructions are more likely sources of problems producing unacceptable results than the sensors themselves. Additional information about standardized testing for resistance temperature measuring devices is available from ASTM International.^{33,34}

Go to the following web link to view a video describing the procedures for calibrating a temperature monitoring system –

<http://www.epa.gov/ttn/amtic/files/ambient/met/temperature.wmv>

EPA guidance³² specifies a tolerance limit of the difference between known and observed values within ± 0.5 degrees C. Calibrations for pairs of ΔT sensors are discussed separately in this section. Calibrations should be made over as much of the measurement range encountered in operational service as possible. Typical sensors are designed for a range from -30 degrees C to +50 degrees C; most stations experience a lesser range.

Following manufacturer's instructions and using the on-site signal processing method ensures that the calibration is representative of the device's response. Note that some temperature probes may not be submersible. If this is the case, then follow the manufacturer's calibration procedures. A step by step description of a water-submersible temperature sensor follows.

1. The calibration test should be performed at three or more temperature levels spaced across the range of the sensor, such as 0 degrees C, 20 degrees C and 40 degrees C.
2. Prepare three test baths as stated in step 1.
3. Remove the sensor from the shield.
4. Place the probe and a NIST traceable temperature device in the water bath with the lowest point, a thermal mass in an ice slurry mixture.
5. To reduce physical stress on the sensors, the probes should be allowed to reach equilibrium with room conditions when they are removed from one thermal mass and before subjecting them to another thermal mass.
6. Record the temperature of the bath from the NIST traceable temperature device and the reading from the station temperature probe.
7. Remove the NIST traceable temperature device and station temperature probe and place them in the 20 degree C water bath. Repeat steps 6 and 7.
8. Remove the NIST traceable temperature device and station temperature probe and place them in the 40 degree C water bath. Repeat steps 6 and 7.

3.4.1 Temperature Environment

Producing stable temperature environments for both the standard device and the sensor that is being calibrated can be a challenge. To compare readings of both sensors at the same temperature, both sensors need to be immersed adequately in the same medium at a stable temperature for enough time to reach thermal equilibrium. Most meteorological sensor response times are fast enough that thermal equilibrium between the thermal environment itself, the standard, and sensor being calibrated can often be reached quickly; waiting a few minutes for a stable output indication from both sensors is necessary to ensure that equilibrium has been achieved.

Most thermistor beads are covered in a metal sheath for physical protection. If this cover is not adequately sealed, it will not be suitable for immersion in a liquid temperature bath. Assuming that the sensor is not adequately sealed is the safer course. The recommended method for producing a stable temperature environment is to place the temperature probes in a thermal mass, such as a cylindrical aluminum block. A block about six inches long and four inches in diameter with holes drilled along the axis of the cylinder is large and heavy enough to accommodate typical temperature sensors. Minimizing the difference between the size of the holes and the diameter of the probes reduces the air around the probe; air at a temperature different from the thermal mass can affect the temperature of the sensor. The holes should be spaced the same distance from the outside; the holes should be nearly the length of the temperature probe to immerse the probe in the thermal mass. The mass can be drilled with various holes to accommodate different sensors, particularly when a ΔT system is being calibrated.

The block is partially immersed in a water bath or ice slurry to reduce equilibration time and to minimize horizontal temperature gradients in the cylinder. The block should be placed in an insulated container to stabilize the temperature of the thermal mass and the temperature sensors. Placing the insulated container on a magnetic stirring table will reduce the time needed for the water bath to reach equilibrium. The ice slurry should be made from distilled water because the presence of foreign material can alter the freezing point of water.

An alternative method is to place the standard and sensor being calibrated in a protective waterproof sheath. The sheath should be made of a thin material to allow for a sensitive response of the sensor to the surroundings, such as a water bath or ice slurry. This approach can reduce the response time, providing the water bath is in an insulated container and is at a reasonably stable temperature.

If the metal sheath properly protects the thermistor to allow immersion in a liquid temperature bath, the sensor and standard device should be simultaneously placed in a water bath. Drill holes in the top of a plastic insulated container to match the diameter of the respective probes. Place the plastic insulated container filled with water near 20 degrees C on a stirring table, place the sensor and standard device in the respective holes to allow simultaneous exposure to the water bath. Allow the water bath to reach equilibrium and record the stable sensor response from the DAS for comparison to the stable standard device response. Repeat this procedure using an ice bath near 0 degrees C and a warm water bath near 40 degrees C.

For simple comparison tests at one ambient temperature level, an adequate result can often be achieved by placing the sensor of an electronic thermometer that is similar to the sensor of the system being checked inside the aspirated shield adjacent to the system sensor, taking care to minimize contact with the shield.

3.4.2 Delta-Temperature

Modern ΔT systems have eliminated the step of requiring a separate analog signal conditioning system to produce a signal related to the temperature difference. A pair of simple temperature measurements made at the two (or more) vertical levels can be digitally processed within the on-site DAS to produce a ΔT result that is readily recorded with other measurements in an output data array.

The recommended calibration technique is to place both sensors being calibrated in the same thermal environment, producing a known ΔT value of 0.0 degrees C. This test should be performed at the three temperature levels used for the absolute calibration of the temperature sensors to assure that the sensors' responses are within tolerance of each other across the working range of the system.

The challenge of ΔT calibration is to ensure that both temperature sensors are truly at the same temperature because the acceptable accuracy reading for ΔT measurements is ± 0.1 degree C. The use of the insulated container and magnetic stirring table will result in the water bath reaching equilibrium.

3.5 Operation and Maintenance

Modern temperature (and ΔT) measuring systems can be very reliable, but they still require occasional physical inspection and data-checking to ensure that the sensors are accurately measuring air temperature. The radiation shields can become clogged with dirt, vegetation, or small animals, so much so that airflow or electrical connections can be adversely affected. Changes to the airflow can be gradual, masking the problem when typical software algorithms search for spurious results. The frequency of the checks should be based on the environment of the system and operating experience.

Another source of potential measurement interference that can be minimized with routine maintenance is the paint covering on the temperature shield. Most paint material degrades over time, producing a dull finish with reflective properties different from those of the fresh, shiny shield when it was new. Birds are notorious for contributing to the changes on the surface of the shields; routinely cleaning the droppings from the shield is advised.

Changes in the fan motors providing aspiration to the shields can be monitored by measuring the current flow to the motors. Airflow through the shield can be sensed by switches, but false problem signals can be produced by unusual wind events that affect the airflow.

3.6 Auditing

Temperature and ΔT measurements should be included in routine performance and system audits at least once every six months. The performance audit should consist of challenging the temperature and ΔT sensors to three test environments at 0 degrees C, ambient temperature, and 40 degrees C using a water bath compared to a NIST-traceable temperature standard. The temperature, ΔT , and NIST-traceable temperature probes are simultaneously placed in a water bath until equilibrium is reached for each desired temperature range. The temperature sensor's response is compared to the audit transfer standard response for each test atmosphere, and the ΔT response is recorded at the same time.

The recommended tolerance for an audit is the same as that for a calibration: ± 0.5 degrees C for temperature and ± 0.1 degrees C for ΔT .

4. Rainfall and Precipitation

Precipitation is defined as, “the total amount of precipitation which reaches the ground in a stated period is expressed as the depth to which it would cover a horizontal projection of the earth’s surface if there were no loss by evaporation or run-off and if any part of the precipitation falling as snow or ice were melted”.¹⁷ In any method of precipitation measurement, the goal should be to obtain a sample that is representative of the fall in the area. At the outset, it should be recognized that the extrapolation of precipitation amounts from a single location to represent an entire region is an assumption that is statistically questionable. A network of stations with a density suitable to an investigation is preferable.

4.1 Types of Instruments and Specifications

There are two basic types of precipitation collectors: non-recording and recording.

4.1.1 Non-recording Rain Gauges

In its simplest form, a precipitation gauge consists of a cylinder, such as a can with straight sides, closed at one end and open at the other. The depth of the liquid in the can is measured with a measuring stick calibrated in subdivisions of centimeters or inches (Figure 4.1).

To obtain greater resolution, an NWS-specified standard 8-inch gauge is constructed with a ratio of 10:1 between the area of the outside collector cylinder and the inside measuring tube. The funnel attached to the collector both directs the precipitation into the tube and minimizes evaporation loss. Amounts in excess of two inches of rainfall overflow into the outer can, and all liquid and melted precipitation measurements are made in the measuring tube with a



Figure 4.1 Cylinder Precipitation Gauge. Source:

<http://www.rap.ucar.edu>

measuring stick.



Figure 4.2 Automatic Wet/Dry Precipitation Collector

The automatic wet/dry precipitation collector (Figure 4.2), available in several designs, represents a specialized non-recording instrument designed for programs involving the chemical and/or radioactive analysis of

precipitation. The collector is built with a sensor that detects the onset and cessation of precipitation and automatically releases a lid to open and cover the collector. In one design, the lid can be made to remain open during either wet or dry periods. Another model is fabricated with two collectors; the lid is made to cover one bucket during periods of rain and snow. In equipment designed for precipitation chemistry, the volume of water, in proportion to the constituents collected with the water, is important, so evaporation must be kept to a minimum.

4.1.2 Recording Rain Gauges

The two basic designs of recording gauges—the weighing-type gauge (Figure 4.3) and the tipping bucket-type gauge (Figure 4.4)—are determined by their operating principles. The former, when made to NWS Specification No. 450.2201, is the Universal Gauge, indicating use for both liquid and frozen precipitation. Options for the remote transmission of signals from this type of gauge are available. The standard NWS Tipping Bucket Rain Gauge is designed with a 12-inch collector funnel that directs precipitation to a small outlet directly over two equal compartments, or buckets, that tilt in sequence with each 0.01 inches of rainfall. The motion of the buckets causes a mercury switch closure. Normally operated on 6 VDC, the contact closure can be monitored on a visual counter and/or by one of several recorders. The digital-type impulse can also be used with computer-compatible equipment.

Some new automatic gauges that measure precipitation without moving parts are available. These gauges use devices such as capacitance probes, pressure transducers, and optical or small radar devices to provide electronic signal that is proportional to the precipitation equivalent.



Figure 4.3 Universal-Weighing Gauge



Figure 4.4 Tipping Bucket Without the Shield

4.1.3 Instrument Characteristics

The recording-type gauge records rainfall begin and end times and measures the rate of fall. The universal-weighing gauge incorporates a chart drum that is made to rotate either by an eight-day spring-wound clock or a battery-powered clock. Recent developments include a unit with a quartz crystal mechanism and gear shafts for a wide range of rotation periods from a half-day to one month.

The weighing gauge is sometimes identified by the name of its designer (Fergusson) and comes with one of two recording mechanisms. In the single traverse unit, the pen moves from the base of the drum to the top, typically a water equivalent of 6 inches. In a dual traverse unit, the pen moves up and then down for a total of 12 inches of precipitation. A variation of the weighing gauge, a “high capacity” design with dual traverse, will collect as much as 760 mm or 30 inches.

To minimize the oscillations incurred by the influence of strong winds on the balance mechanisms, weighing gauges are fitted with a damper immersed in silicone fluid. By incorporating a potentiometer in the mechanism, the gauge is capable of providing a resistance or, with another refinement, a voltage proportional to the amount of precipitation collected. Linearity of response is usually a factory adjustment involving the use of calibrated weight to simulate precipitation amounts. Despite manufacturer’s specifications, it is doubtful that the gauge can resolve 0.01 inches, especially when the bucket is nearly empty.

In the tipping-bucket gauge, the balance of the buckets and the leveling of the bucket frame are critical. Low voltage at the gauge is imperative for reasons of safety. Power is typically 6 VDC. The signal is provided by a switch closure each time the bucket assembly tips (0.01 inches of rainfall per bucket). Rain rates are calculated from an event recorder with pens energized sequentially to improve resolution. The tipping bucket (a mechanical device) takes time to tilt from one position to the next. When the rate of fall is high, spillage occurs and the unmeasured precipitation falls into the reservoir. When greater accuracy is needed, the collected water is measured manually and excess amounts are allocated proportionately in the record. Accessories – Windshields and Heaters

Measurement accuracy for all types of gauges is influenced by exposure more than by variation in design. Windshields represent an essential accessory to improve the catch of precipitation, especially snow under windy conditions. The improved Alter design, made of 32 free-swinging but separated leaves supported 1/2 inch above the level of the gauge’s collecting orifice, is an effective way to improve the catch. In a comparison of shielded and unshielded 8-inch gauges at a wind speed of 5 mph, the efficiency of the unshielded gauge decreases by 25 percent, and at 10 mph, the efficiency of the gauge decreases by 40 percent.³⁵



In below-freezing conditions when the catch in a gauge is snow or some other form of solid precipitation, the collector/funnel of non-recording gauges and the funnel in recording gauges must be removed. Some instruments are available with built-in heater elements that are thermostatically controlled. An effective heater for conditions that are not too severe is an incandescent lamp installed in the housing of the gauge. Caution should be exercised because too much heat will result in

Figure 4.5 Example of an Alter Wind Shield

evaporative loss.

4.1.4 Precipitation Data Recommendations

In research studies, especially those related to acid rain, the instrument used most frequently is the automatic precipitation collector with one or two collecting buckets and a cover to prevent evaporation. In operational activities, the choice is the weighing gauge or the tipping-bucket gauge. For climatological surveys, the choice might include both recording and non-recording type gauges. The use of a windshield is recommended to minimize errors that result from windy conditions if the application requires maximum accuracy. The precipitation measurement made at air quality monitoring stations is frequently used for descriptive purposes or for episodic analysis. If effort is required to achieve accuracy levels that are greater than the manufacturer's specifications for electrical recording gauges, then a 10 percent tolerance limit may be adequate.

4.1.5 Procurement

Purchasing a suitable precipitation measuring system requires specifying the type of system that fits the data application and the accuracy consistent with that application. A variety of gauges are available commercially. In general, NWS-specified standards result in the fewest problems. For example, numerous 8-inch gauges are available, but those conforming to NWS specifications are made only of brass and copper, are more durable, and are reported to rupture less frequently under extended freezing conditions than those made of galvanized steel.

The procurement of a weighing- type gauge should include a tripod mounting base as well as a set of calibration weights. For locations that are not readily accessible or locations with heavy precipitation, the bucket of the weighing gauge should have an overflow tube. If time resolution is not important, drum-type, recording rain gauges can be obtained with monthly rather than weekly mechanisms. The tipping-bucket gauge must be equipped with a heater for use when precipitation is frozen.

4.2 Acceptance Testing

Except for visual inspection, non-recording gauges do not require acceptance testing. The weighing gauges should be assembled and given a quick "bench-top" calibration check with standard weights or a measured volume of water. In addition, the clock mechanism supplied with the gauge should be checked for at least a couple of days, preferably a week. The tipping bucket gauge should also be bench-tested, primarily to be certain that the bucket mechanism assembly is balanced and that the switch is operational.

4.3 Calibration

Bench calibrations should follow the manufacturer's recommendation. The electrical output gauge or the drum recording gauge measures weight, whether total weight in the case of the weighing gauge or increments of weight in the case of the tipping-bucket gauge. Density of water is assumed so the weight can be expressed in units of volume or depth assuming the area of the collector opening. Calibrations of the measurement apparatus can be based on the introduction of known volumes of water. The area of the collection surface must be known so that the volume collected can be expressed as a depth. For example, an 8- inch collector may feed a tipping bucket which tips when 7.95 cc of water has arrived. If this volume of water represents 0.01 inches of rainfall, the effective collection area must be 48.51 square inches, using the following calculations:

$$7.95 \text{ cc} = 0.485 \text{ in.}^3 = 0.01 \text{ in.} * 48.51 \text{ in.}^2 \quad (4-1)$$

If the area is a circle, the diameter should be 7.86 inches.

$$(48.51/\pi)^{1/2} = 3.93 \text{ in. radius} \quad (4-2)$$

For rate-sensitive systems such as the tipping bucket, the rate of simulated precipitation should be kept constant to achieve 1 tip every 15 seconds. Calibrations require properly leveled weighing systems (gauges) whether on the bench or in the field.

Go to the following web link to view a video describing the procedures for calibrating a tipping bucket rain gauge: <http://www.epa.gov/tn/amtic/files/ambient/met/tipping-bucket.wmv>.

4.4 Operation and Maintenance

4.4.1 Installation

The support, or base, of any gauge must be firmly anchored, preferably on a level surface so that the sides of the gauge are vertical and the collector is horizontal. The collector can be checked with a carpenter's level placed at two intersecting positions. The level of the bucket assembly on the tipping bucket gauge is also critical and should be checked along its length and width.

The gauge should be shielded from the wind but not placed in an area where there will be excessive turbulence caused by the shield. For example, a good location is an opening in an orchard or grove of trees where the wind speed near the ground is reduced by the canopy effect. A location open but for a few trees would be less desirable because of strong eddies that can be caused by the trees. Obstructions to the wind should not be closer than two to four times the obstruction height from the instrument. In open areas, a wind shield such as that specified by the NWS should be used. The ground surface around the rain gauge may be natural vegetation or gravel. It should not be paved so as to avoid splashing the gauge. The gauge should be mounted a minimum of 30 cm (approximately 1 foot) above the ground and should be high enough that it will not be covered by snow.

After the weighing gauge is installed, the silicone fluid should be poured into the damping cylinder as required. The hygroscopic ink-filled pen of the drum recording type is inked to less than capacity because the ink expands with increasing humidity and can easily spill over the chart. The final calibration check with standard weights or suitable substitute should be made.

To check the operation of the tipping bucket, a known quantity of water equivalent to 10 tips should be placed in a separatory funnel. The separatory funnel is adjusted to allow the water to flow into the tipping bucket at a rate of 1 tip every 15 seconds. It may be necessary to adjust the set screws, which act as limits to the travel of the tilting buckets. Adjustment is required if there is a 10 percent or greater error or if greater accuracy is needed.

4.4.2 Field Operation of a Precipitation Measurement System

Calibration checks for weighing and tipping bucket gauges using the techniques described above are recommended at six-month intervals. Non-recording gauges, whether used alone or in a network, should

be read daily at a standard time. Although the weighing gauge is used for liquid and frozen precipitation, it requires special attention during winter operations. The funnel must be removed when snow is expected, and the bucket must be charged with an antifreeze—24 oz of ethylene glycol mixed with 8 oz of oil. The weight of this mixture represents the baseline for which precipitation amounts are to be noted. The bucket should be emptied and recharged when necessary, at about 5 inches in the universal gauge. Antifreeze mixture classified as hazardous should be disposed of properly. All operational activities should be recorded in the station log.

4.4.3 Preventive Maintenance

Possible leaks in the measuring tube or the overflow container of the gauge can be easily checked. The receptacles, partially filled with water colored with red ink, can be placed over a piece of newspaper. This procedure is especially applicable to clear plastic 4-inch gauges which are more easily damaged. Repairs can be performed by soldering an 8-inch gauge and by applying a solvent to the plastic gauge.

A number of pens, some with greater capacity than others, can be used with the universal gauge. All gauges require occasional cleaning by a good soaking and wiping in a mixture of water and detergent.

The chart drive is another source of problems; but they can sometimes be avoided by lubricating the clock drive for the environmental conditions expected. Keeping spare clocks in stock is good practice.

Routine visual checks of the performance of weighing-type gauges should be made every time there is a chart change. The time and date of change and site location should be documented. Routine maintenance should include inking the pen and winding the clock. Battery-powered chart drives will require periodic replacement of batteries based on the manufacturer's recommendations.

The tipping bucket funnel and tipping apparatus should be checked and cleaned, if necessary, during each site visit. The tipping apparatus should be checked for proper operation at each site visit by manually tipping the apparatus at least 10 times and confirming that the 10 tips were recorded by the recording device. All preventive maintenance activities should be noted in the log book.

4.5 Auditing

Audits of precipitation measuring systems every six months are adequate. The irregular occurrence of precipitation makes the use of a certified transfer standard impractical. The performance audit should depend on challenging the gauge with amounts of water known to an accuracy of at least 1 percent of the total used. This method determines the measurement system accuracy but not the collection efficiency of the gauge in natural precipitation. For tipping bucket gauges, a rate of less than one inch per hour should be used and an amount which will result in a minimum of 10 tips. For weighing gauges, using calibration weights to challenge the weighing mechanism is more convenient rather than using of the quantities of water necessary for full-scale testing.

5. Relative Humidity and Dew Point Determination

Of the many atmospheric variables describing water vapor content in the atmosphere, relative humidity is the most common for routine monitoring programs. Relative humidity is the ratio (percent) of actual vapor pressure of moist air to the saturation vapor pressure at the same temperature. Dew-point temperature (or dew point) is the temperature to which a moist air parcel must be cooled to achieve saturation over water at constant pressure and water vapor content. The corresponding temperature with respect to ice is the frost point.

Dew point measurement was more reliable than relative humidity measurement before the invention of modern hygrometers. Dew point measurement equipment is now more expensive and often requires more electric power and routine maintenance than is practical for remote stations.

5.1 Types of Instruments and Specifications

The discussion of relative humidity instrumentation is limited to equipment most frequently used for routine environmental monitoring and/or standards used to test monitoring equipment. As with temperature measurement, relative humidity instruments measuring in outside air must be protected from solar and terrestrial radiation, precipitation, and wind influences. Hence, relative humidity sensors, similar to temperature sensors, are typically mounted in naturally or mechanically aspirated shields. Examples of these shields can be seen in Figures 3.2 and 3.3. Another examples is shown in Figure 5.1 below. An example of a combination relative humidity/temperature probe is illustrated in Figure 5.2.



Figure 5.1 A Motor-Aspirated RH Shield.
Source: <<http://www.youngusa.com/>>



Figure 5.2 A Typical RH Probe.
Source: <<http://www.metone.com/>>

5.1.1 Electrical hygrometer

Advances in electronic manufacturing have provided the meteorological community with alternatives to chilled-mirrors, wet-bulb thermometers, and wire-wound salt-coated bobbins. The resistance and capacitance of thin hygroscopic films on modern hygrometers are affected by the presence of moisture. Measurement circuits provide the instrument output with scaled voltages and readouts of atmospheric moisture content. Corresponding temperature measurement is included within the instruments to calculate the results expressed in variables other than actual moisture content.

Subtle differences in the type of sensor can create measurement advantages for certain moisture content levels.³⁶ Capacitive and resistive sensors respond better to relative humidity than to dew point. Specifications for both types of sensors are similar. Capacitive sensors are most linear at low humidity levels and can tolerate condensation, although calibration shifts can occur. Resistive sensors are most linear at high humidity levels and cannot tolerate condensation, although some have automatic protection from saturation conditions. Dew point impedance sensors use a slightly different element; they measure absolute rather than relative humidity. The sensors are covered by membranes that are readily porous to moisture, although the membranes thermally insulate the sensor, causing some lag time in measurement. Electrical hygrometers are considerably less expensive than some other automated relative humidity measurement methods and are readily adaptable to portable, hand-held units suitable for temporary measurements and transfer standard use.

5.1.2 Chilled mirror

Dew point (or frost point) can be measured directly using thermoelectric cooling and precise temperature measurement and control. A mirror surface is cooled until dew (or frost) forms on the surface. The temperature of the mirror surface is measured, and that measurement is the dew (frost) point temperature. The engineering aspects of airflow, temperature control, and optical identification have been refined in modern equipment. Optical identification improvements have reduced the occurrences of mistaking contamination on the mirror for condensed moisture, but mirror cleaning remains a necessary activity for reliable dew point measurement.

An excellent reference for chilled-mirror measurements of dew point and frost point is the ASTM International Standard D4230.³³ This standard includes analytic expressions for saturation vapor pressure as functions of temperature and relative humidity, which can be used to convert between these variables.

5.1.3 Psychrometer

The psychrometer contains two identical thermometers—dry-bulb and wet-bulb. Dry-bulb temperature is air temperature. Wet-bulb temperature is the temperature of an air parcel if cooled adiabatically (no external heat transfer) at constant pressure to saturation by evaporation of water into the parcel. The wet-bulb thermometer has a small cotton cover on the thermometer's bulb; the cover is soaked in distilled water and spun around, or otherwise ventilated, until the reading stabilizes at the wet-bulb temperature. ASTM International Standard E337³⁷ covers psychrometer measurements and the associated calculations of other humidity variables. Engineers still use wet-bulb temperature for heating, ventilating, and air conditioning calculations.

5.2 Acceptance Testing

After equipment is newly installed or returned from maintenance or calibration by vendors located elsewhere, it is prudent to check the equipment for proper operation. Damage can occur in shipping and handling that can affect the response. Simple checks for reasonable responses can be adequate initial acceptance testing; precautions identified in the formal field check should be observed during testing. The formal check is recommended during installation at the operating site.

5.3 Installation and Wiring

Relative humidity and dew point sensors should be mounted over a plot of open level ground at least 9 m in diameter. The ground surface should be covered with non-irrigated or unwatered short grass or, in areas where grass does not grow, natural earth. The surface must not be concrete or asphalt or oil-soaked. The standard height for climatological purposes is 1.25 m to 2 m, but required heights may frequently be different in air quality studies.

The sensors should not be closer to obstructions, such as trees and/or buildings, than a distance equal to four times their height. They should be at least 30 m from large paved areas and not close to steep slopes, ridges, or hollows. Areas of standing water should also be avoided. Louvered instrument shelters should be oriented so that the door opens toward true north in the northern hemisphere. Motor-aspirated shields should also be oriented with the sensors toward true north in the northern hemisphere.

Proper planning assures that the mounting hardware, cables, power supply, and so forth are all compatible and available and helps an installation proceed without difficulty. Purchasing equipment through a vendor who provides everything the system needs to readily attach cables can save considerable technical time and effort of having to fabricate mounting hardware and prepare cables. Additional lightning protection should be considered in areas where lightning occurs.

Most relative humidity sensors do not require additional power beyond the excitation voltages in the bridge circuit, although motor-aspirated temperature shields require electrical power. Shields can be powered by direct current (DC) fans operating on batteries being recharged by solar panels or an alternating current (AC) trickle charging unit. Operating the system on DC, even when AC power is available, can reduce the missing data periods when electrical power is unavailable.

A complete quality assurance plan will prescribe appropriate installation and testing procedures. These procedures are developed from manufacturers' specifications and guidance and instrument exposure recommendations listed in monitoring guidance documents. For general purposes, the relative humidity sensor is mounted 2 m above ground level, with the inlet facing away, and at a distance of approximately 1.5 times the tower diameter, from the tower. Influences from nearby artificial or natural moisture sources can adversely influence relative humidity measurement so that it will not be representative of the surrounding area.

5.4 Calibration

Calibrating a relative humidity measurement system consists of comparing the output of the device being calibrated to a known value and determining if the difference is within acceptable tolerance limits. Modern relative humidity measurement systems may include software calibration adjustment capability. The quality assurance plan for the monitoring program should offer guidance about when to make adjustments and when to leave an instrument in the as-found mode. An essential factor in obtaining two comparable relative humidity measurements is that the sensors be reasonably close to the same temperature. The basic sensor measurement is molecular water vapor. Data displays in relative humidity and dew point involve algorithms that include temperature, so two sensors at significantly different temperatures would provide different output values for the same moisture exposure.

Go to the following web link to view a video describing the procedures for calibrating a relative humidity and dew point monitoring system: <http://www.epa.gov/ttn/amtic/files/ambient/met/temperature.wmv>.

EPA guidance⁴ specifies a tolerance limit of the difference between known and observed values within ± 1.5 degrees C in terms of dew-point temperature. For relative humidity values less than about 40 percent, the acceptable dew point difference translates to a relative humidity value smaller than most instruments can provide. Hence, a two-tier system of an acceptable relative humidity of ± 7 percent when less than 40 percent and using the recommended dew point difference above that level can provide consistent criteria across the range of relative humidity levels.

Calibration tests performed in the field using the full system for relative humidity measurement and signal processing used during routine operation reduce testing uncertainty, although the trade-off can be the difficulty in providing a stable humidity environment at a field site. The calibration test should be performed at three or more humidity levels spaced across the range of the sensor within the range of the environment producing the stable atmosphere. The typical calibration ranges are 35 percent, 50 percent, 75 percent, and 90 percent, respectively.

ASTM International Standard E104³⁸ describes methods to produce stable humidity levels using aqueous salt solutions. These solutions are sensitive to temperature, so reliable tests in an exposed location can be difficult. Small commercial chambers capable of maintaining preset humidity levels can provide the stable environment needed for calibration checks across a range of conditions. The need for temperature stability often necessitates using these chambers in a reasonably well-controlled environment.

The high accuracy and quality of hand-held sensors provides a readily available resource for field tests of relative humidity systems, providing the tests can be made in reasonably stable atmospheric conditions.

5.5 Operation and Maintenance

Modern relative humidity measurement systems can be very reliable systems, but they still require regular physical inspection and data-checking to ensure that the sensors are accurately measuring the relative humidity of the air. The radiation shields can become clogged with dirt, vegetation, or small animals, so much so that airflow or electrical connections can be adversely affected. Changes to the airflow can be gradual, masking the problem when typical software algorithms search for spurious results. The frequency of the checks should be based on the environment of the system and operating experience. Checks of the shields typically are the same as those for the corresponding temperature measurement. The protective screen covering the relative humidity element has a tendency to become clogged, especially if the aspirated shield is in need of cleaning. Routine inspection of the protective screen is necessary. If the protective screen is dirty or clogged, it should be replaced with a clean spare screen.

5.6 Auditing

Relative humidity measurements should be included in routine performance and system audits at six-month intervals. The performance audit can consist of a simple one-point check against a hand-held relative humidity measuring standard; however, a more complete challenge of the relative humidity sensor using standard salt solutions or a portable humidity chamber is recommended. Using an electric cooler can create a sufficiently stable environment in which to conduct a three-point relative humidity audit using standard salt solutions referenced to a NIST-traceable transfer standard. Another option for conducting the in situ relative humidity audit is to use a battery-powered, portable humidity generator to produce multiple humidity ranges.

6. Quality Assurance of Solar Radiation Measurements

6.1 Introduction

Solar energy is the driving force behind large-scale atmospheric motion. Many air pollution specialists consider the measurement of solar radiation secondary to wind and temperature measurements; however, solar radiation is directly related to atmospheric stability. It is measured as total incoming global radiation, as outgoing reflected and terrestrial radiation, and as net total radiation.³⁹ Solar and/or net radiation data are used (1) to determine atmospheric stability for calculating various surface-layer parameters, (2) in dispersion modeling for estimating convective (daytime) mixing heights, and (3) for modeling photochemical reactions.⁴ Solar radiation refers to the electromagnetic energy in the solar spectrum (0.10 to 4.0 μm wavelength). The solar spectrum comprises ultraviolet light (0.10 to 0.40 μm), visible light (0.40 to 0.73 μm), and near-infrared radiation (0.73 to 4.0 μm). Net radiation includes both solar radiation (also referred to as short-wave radiation) and terrestrial or long-wave radiation. The sign of the net radiation indicates the direction of the flux (a negative value indicates a net upward flux of energy).

6.2 Solar Radiation

The sun generates about 3.9×10^{26} Watts of energy. This energy is radiated into space uniformly. Radiation decreases as the inverse square of the distance from the Sun. The solar constant (S_0) is the average energy per unit area of solar radiation falling on the surface of a sphere of radius R around the Sun (see Equation 6-1).

$$S_0 = E/(4\pi R^2) = 1370 \text{ W/m}^2 \quad (6-1)$$

Where

- R = the distance between the Earth and Sun, ~150,000,000 km
- E = Total Solar Energy 3.9×10^{26} W
- W/m² = Watts/meter²

The solar “constant” actually fluctuates and the energy the planet receives varies with the seasonal change in the Earth/Sun distance. If one astronomical unit (AU) is the average Earth/Sun distance, then the amount of solar radiation reaching Earth varies according to Equation 6-2.

$$\begin{aligned} S_{\text{max}} &= S_0/(1 - e)^2 = S_0/(1.017)^2 = 1417 \text{ W/m}^2 \\ S_{\text{min}} &= S_0/(1 + e)^2 = S_0/(0.983)^2 = 1324 \text{ W/m}^2 \end{aligned} \quad (6-2)$$

Where e is the eccentricity (a measure of departure from a circle) of Earth's orbit around the Sun.

Earth's eccentricity varies. The current value is about 0.017. The maximum and minimum values vary slightly more than 3 percent from the mean. Earth is closest to the Sun in early January and receives the maximum amount of radiation during this time. The minimum amount of radiation is received about six months later.

Visible, infrared (IR), and ultraviolet light (UV) and heat are important constituents of solar radiation. The Sun's energy is distributed over a broad range of the electromagnetic spectrum. It behaves approximately like a "blackbody" radiating at a temperature of about 5,800 degrees Kelvin. Its maximum output is in the green-yellow part of the visible spectrum. Figure 6.1 illustrates the energy versus wavelength of light emitted by our Sun.

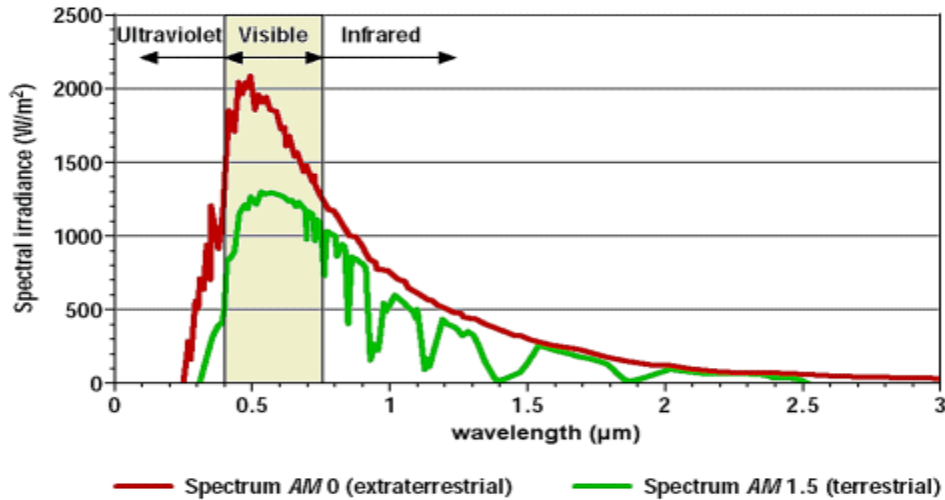

Figure 6.1 Solar Irradiance Versus Wavelength of Light Emitted by the Sun

Radiation is not emitted by the Sun in a uniform manner. Irregularities result from processes in the Sun's interior and on its surface.

Quantitatively, solar radiation is described in units of energy flux, usually W/m^2 . When measured in specific, narrow wavelength bands, solar radiation may be used to evaluate such air pollution indicators as turbulence and an indicator of photochemical processes. This section describes instruments that measure broadband radiation and sunshine duration. Specifications, acceptance testing, installation, calibration, operations/maintenance, and auditing procedures are described for the different instrument types.

6.3 Types of Instruments

Instruments used to measure the transmission of sunlight through Earth's atmosphere fall into two categories: instruments that measure radiation from the entire sky (pyranometers) and instruments that measure only direct solar radiation (pyrheliometers). For each instrument category there are two measurement methods: thermal (i.e., thermopiles) and photovoltaic detectors.

6.3.1 Pyranometers

Pyranometers are instruments that measure solar radiation received from a hemispherical section of the atmosphere. A pyranometer measures solar radiation, including the total Sun and sky shortwave radiation on a horizontal surface. Pyranometers that measure net total radiation are termed net radiometers. Most pyranometers incorporate a thermopile as a sensor. Some use a silicon photovoltaic cell as a sensor. The precision spectral pyranometer (PSP) is made by Eppley Laboratories (see Figure 6.2) and has two

hemispherical domes designed to measure Sun and sky radiation on a horizontal surface in defined wavelengths.



Figure 6.2 Eppley Pyranometer PSP

The Eppley Model PSP pyranometer is a widely used “first class” reference instrument as defined by the World Meteorological Organization. This instrument is about 15 cm in diameter. The sensor is under the hemispherical glass dome. The glass is specially formulated to transmit solar radiation over a wide range of wavelengths. Figure 6.3 is an illustration of the Eppley pyranometer.

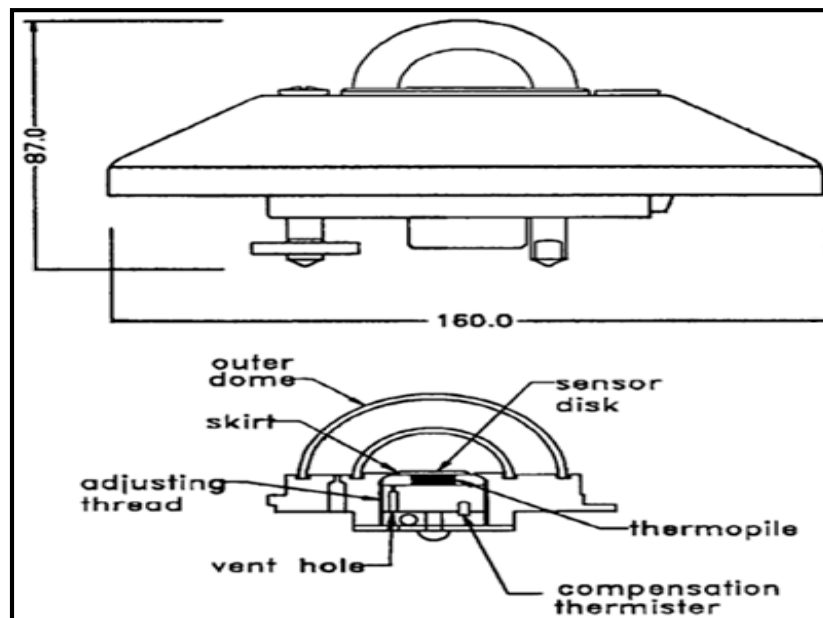

Figure 6.3 Illustration of an Eppley Pyranometer

Because pyranometers measure solar radiation from the sky, it is imperative that monitoring sites have a 360° view of the horizon, without significant obstacles. Corrections can be made for some obstructions but, the clearer the horizon is, the more accurate measurements will be.

A less obvious recommendation is that pyranometers have excellent “cosine response” to direct sunlight. If sunlight has intensity I_0 when the Sun is directly above a horizontal surface (zenith angle of 0°), then the intensity I_z at some other zenith angle z is a function of the angle (Equation 6-3).

$$I_z = I_0 \cos(z) \quad (6-3)$$

If an ideal detector on a horizontal surface is illuminated by direct light, then its response should be proportional to the cosine of the zenith angle of the light source.

Pyranometers usually do not have perfect cosine response. Cosine response corrections can be determined and applied for a direct light source, but this issue becomes much more complicated under partly cloudy skies, when the radiation incident on a detector is an unknown combination of direct sunlight and diffuse sky radiation, as is the case for full-sky solar radiation.

High-quality reference pyranometers, such as the Eppley pyranometer shown in Figure 6.3, use thermopiles, which are collections of thermocouples. Thermocouples consist of dissimilar metals placed together or joined. At the interface of the thermocouple are two dissimilar metals with different electronic valence configurations. They produce a small current proportional to their temperature. When thermopiles are appropriately arranged and coated with a dull black finish, they serve as nearly perfect “black body” detectors that absorb energy across the range of the electromagnetic spectrum. Ideally, the response of the thermopile sensor in the pyranometer is proportional to the cosine of the angle of the solar beam and is constant at all azimuth angles. This characteristic is known as the Lambert Cosine Response, an important characteristic of pyranometers.

Most net radiometers now available commercially are made with a small disc-shaped thermopile covered by polyethylene hemispheres. In most units the material used for shielding the element from the wind and weather is very thin and is transparent to wavelengths of 0.3 to 60 μm . Until recently, the internal ventilation and positive pressure required to maintain the shape of the hemispheres of net radiometers was considered critical; however, new designs have eliminated this problem.

The LiCor pyranometer (Figure 6.4) is a popular thermopile radiometer with a silicon photovoltaic detector mounted in a fully cosine-corrected miniature head. The current output is directly proportional to solar radiation.

The NovaLynx pyranometer (Figure 6.5) operates on the principle of temperature difference created by light absorption of light material (white) and dark material (black) when exposed to solar radiation. The temperature difference is proportional to the radiation intensity.



Figure 6.4 LiCor Pyranometer



Figure 6.5 NovaLynx Pyranometer

6.3.2 Pyrheliometers

A pyrheliometer is an instrument that measures the intensity of direct solar radiation at normal incidence. In other words, it measures the direct radiation from the Sun, not total or incident solar radiation. Pyrheliometers work on the same physical principles as pyranometers, i.e., using thermopiles to create a current that can be measured by an electronic circuit.

A number of different vendors manufacture pyrheliometers. Perhaps the most common pyrheliometer is the Eppley Normal Incidence Pyrheliometer (Figure 6.6).

A pyrheliometer is mounted in a solar tracker, or equatorial mount, automatically tracking the Sun as it moves across the sky. In contrast, a pyranometer is mounted facing the zenith (i.e., facing a point on the celestial sphere directly above the observer). Figure 6.7 shows an example of a solar tracker. The solar tracker must be placed in a location that has line of sight of the horizon

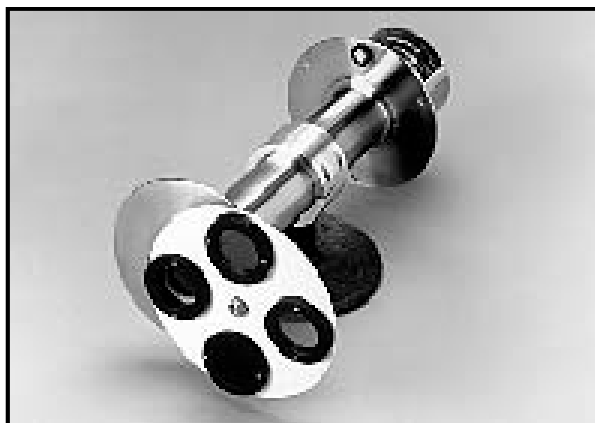

Figure 6.6 Eppley Normal Incidence Pyrheliometer



Figure 6.7 Eppley Solar Tracker

6.4 Specifications

When purchasing a solar radiation measurement system, match the data recommendations to the instrument selection. Refer to Tables 0-1 through 0-9 to match the sensor performance with the type of sensor needed for your circumstance. The measurement quality objectives and calibration/auditing recommendations are detailed in those tables. Specify the required performance on the purchase order. Be sure to note which test method you will use to verify performance and test the instrument after receipt.

Class 2 sensors (as defined by the World Meteorological Organization) offer the advantage of providing data comparable to those collected at National Weather Service stations and at key Department of Energy (DOE) locations. Specified sensors should be commercially available and meet the technical recommendations established by the measurement quality objectives detailed in Tables 0-1 through 0-9. ASTM International standards are available.²⁴ When purchasing a recorder or data acquisition system (DAS), your agency should match the calibration factor or sensitivity of the sensor to the readout equipment. Note that the signals from pyrhemometers (in contrast to pyranometers) require zero-offset capability to accommodate both negative and positive voltage outputs.

6.5 Acceptance Testing

Physical inspection of the relatively fragile pyranometers and pyrhemometers should be done immediately after delivery of an instrument. Upon delivery, a pyranometer or pyrhemometer should be accompanied by a calibration certificate that states that the instrument has been calibrated to a NIST-traceable radiometer. Be sure that the calibration data have been received and that these data correspond to the serial number of the instrument. Storage of calibration information at the main office and in the field will prove helpful when instrument calibration needs to be checked. A quick determination can be made indoors as to whether the sensor is operating by exposing the sensor to the light of a tungsten lamp. It may be necessary to place the instrument fairly close to the lamp. Covering the sensor for several hours will ensure that the system is not “dark counting”. Zero response confirms that the sensor baseline response is acceptable and the sensor can be used to collect data. If the sensor response is greater than zero, the sensor should not be used to collect data and the manufacturer should be contacted.

6.6 Installation, Instrument Exposure, and Wiring

The site selected for an upward-looking pyranometer should be free from any obstruction above the plane of the sensor and should allow easy access for cleaning and maintaining the instrument. It should be located so that shadows will not be cast on the device and away from light-colored walls or other objects likely to reflect sunlight. A flat roof is usually a good choice; but if such a site is not possible, a rigid stand with a horizontal surface some distance from buildings or other obstructions should be used. A site survey of the angular elevation above the plane of the radiometer surface should be made through 360 degrees.

The same procedures and precautions should be followed for net radiometers that are both upward- and downward-facing. Figure 6.8 shows a net radiometer. However, the net radiometer must be supported on an arm extending from a vertical support about 1 m above the ground. Except for net radiometers with heavy-duty domes, which are installed with a desiccant tube in series with the sensor chamber, most other hemispherical net radiometers require the positive pressure of a gas, usually nitrogen, to both maintain the shape of the polyethylene domes and purge the area surrounding the thermopile. Some of the more

popular net radiometers incorporate internal purging with nitrogen and external ventilation with compressed dry air through holes on the frame. The compressed air supply minimizes fogging and condensation.

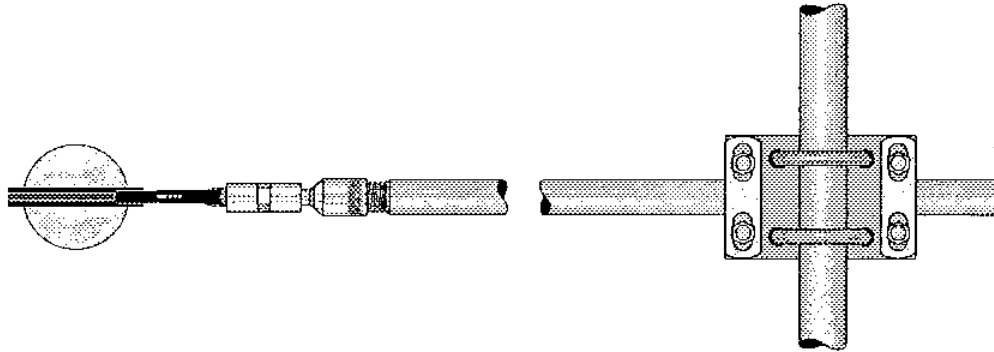

Figure 6.8. Net Radiometer

Precautions must be taken to avoid subjecting net radiometers to mechanical shock during installation. They should be installed securely and leveled using the circular spirit level attached to the instrument. Net radiometers are difficult to mount and to maintain free of vibration. Pyranometers of the Moll-Gorzynski design, manufactured by Kipp & Zonen (www.kippzonen.com), are oriented so that the emerging leads face north. This minimizes solar heat on the electrical connections of an instrument that is not temperature compensated. The thermopiles of these instruments should be oriented so that the long side of the thermopile points east and west.⁴⁰ The cable used to connect the pyranometer to the readout device, recorder, or integrator should be between 16 and 20 gauge and made of shielded, waterproofed 2-conductor copper wire. The sensor, shield, and readout device should be connected to a common ground. Potentiometric millivolt recorders are to be used with most high-impedance, low-signal radiometers. Cable lengths of 300 m or more are practical.

6.7 Calibration

Pyranometers and net radiometers should be subjected to field calibration checks on two consecutive cloudless days. These checks involve a side-by-side comparison of the on-site reporting sensor to a transfer standard sensor of similar design (it is recommended that it be the same make to eliminate any bias). The transfer standard sensor must have a NIST-traceable calibration within a year of the date of the calibration. If a side-by-side calibration is not possible, the device must be returned to the manufacturer or to a laboratory that has facilities to check the calibration. Pyranometers and net radiometers should be calibrated once every six months. Any indication of discoloration or peeling of a blackened surface or of scratches on the hemispheres of a pyranometer warrants recalibration and/or service.

Calibrating the recorder or integrator is an easy task. The standard method involves the use of a precision potentiometer to impress known voltages into the circuit. The linearity of the readout instrument may be checked by introducing a series of voltages covering the full scale, checking first up-scale and then down-scale. Adjustments should be made as necessary. In the absence of a precision potentiometer, it may be possible to introduce a calibrated millivolt source capable of checking the up-scale and down-scale responses of the recorder. Integrators can be checked the same way, except that the input value must also be timed.

The self-calibrating Absolute Cavity Pyrheliometer (Figure 6.9), Model HF, has been a reference standard level device for many years. The sensor consists of a balanced cavity receiver pair attached to a circular wire-wound and plated thermopile. The blackened cavity receivers are fitted with heater windings which allow for absolute operation using the electrical substitution method, which relates radiant power to electrical power in international system (SI) units. The forward cavity views the direct beam through a precision aperture. The precision aperture area is nominally 50 mm⁴ and is measured for each unit. The rear receiver views an ambient temperature blackbody. The Model HF radiometer element with baffle tube and blackbody fit into an outer tube which acts as the enclosure of the instrument. The Model AHF has an automatic shutter attached to the outer tube.



Figure 6.9 Absolute Cavity Pyrheliometer

The operation of the cavity radiometer and the measurement of the required parameters are performed using an appropriate control box. The control functions include setting of the calibration heater power level, activation of the calibration heater, selection of the signals to be measured, and control of the meter measurement functions and ranges. The measured parameters include the thermopile signal, the heater voltage, and the heater current which is measured as the voltage drops across a 10-Ohms precision resistor. The instrument temperature may also be measured using an internally mounted thermistor. The meter resolution of 100 mV allows for a thermopile signal equivalent in radiation to approximately 0.1 W/m².

6.8 Operations and Maintenance

As part of the quality assurance program, a field calibration check of the solar radiation sensor should be performed at least once every six months according to the procedures outlined in Tables 0-1 through 0-9. The data should be inspected for a reasonable diurnal pattern and the absence of dark counting. Where strip chart or digital printers are used, daily time checks are desirable to confirm proper time sequence of the chart or printer. Frequency of data retrieval will depend upon program objectives; but even for climatological programs, data should be collected monthly. All operational activities during a site visit should be logged.

6.8.1 Preventive Maintenance

All types of radiometers require frequent cleaning to remove any material deposited on the surface that may intercept the radiation. Ideally, this operation is daily. The outer hemisphere should be wiped clean and dry with a lint-free soft cloth and alcohol. Any scratching of the surface will alter the transmission properties of the glass, so cleaning must be done with care. If frozen snow, glazed ice, hoarfrost, or rime ice is present, an attempt should be made to remove the deposit carefully with warmed cloths.

Should the internal surface of a pyranometer's outer hemisphere become coated with moisture, it can be cleaned by carefully removing the outer hemisphere on a dry day and allowing the air to evaporate the moisture, then checking the desiccant. If removal of a hemisphere exposes the thermopile element, extreme care should be taken because it is fragile and easily damaged. About once each month, the desiccant installed in most pyranometers should be inspected. Whenever the silica gel drying agent is pink or white instead of blue, it should be replaced or rejuvenated by drying it out on a pan in a 135 degrees C oven. The level alignment should be checked after each servicing of the pyranometer, or at least monthly. Significant errors can result from misalignment.

Pyrheliometers require maintenance more frequently than pyranometers. It is necessary to replace the polyethylene domes in pyrheliometers as often as twice a year or more before the domes become discolored, distorted, or cracked. More frequent replacement is necessary in polluted environments due to accelerated degradation of plastic hemispheres when exposed to pollutants. A daily maintenance schedule is essential to check on the proper flow of gas in instruments that are inflated and purged with nitrogen. All maintenance activities should be recorded.

6.9 Auditing

Installation of a certified transfer standard (CTS) is the only practical means of conducting a performance audit on a solar radiation system. The CTS must have the spectral response and exposure equivalent to the on-site sensor being audited. One diurnal cycle will establish an estimate of accuracy sufficient for most air quality monitoring applications. If one diurnal cycle is not possible, the audit should be conducted several hours prior to and after the peak solar radiation at the time of the audit. The CTS and the on-site solar radiation sensor should be covered to determine the zero response of each instrument. If the meteorological site is equipped with a DAS, the CTS should be interfaced with a spare channel and the DAS initialized to represent the accurate full scale and zero values of the CTS. Data from the CTS and the on-site solar radiation sensor should be reported as daily integrated values, hourly integrated values, and average intensity per hour to provide a meaningful comparison. An audit frequency of at least six months is recommended.

7. Quality Assurance for Atmospheric Pressure Measurements

The atmospheric pressure on a given surface is the force per unit area exerted by virtue of the weight of the atmosphere above. The pressure is thus equal to the weight of a vertical column of air above a horizontal projection of the surface, extending to the outer limit of the atmosphere.¹²

7.1 Units and Scales

The basic unit for atmospheric pressure measurements is the Pascal (Pa). It is accepted practice to add the prefix “hecto” to this unit when reporting pressure, making the hectopascal (hPa), equal to 100 Pa, the preferred terminology. This is largely because one hPa equals one millibar (mb), the formerly used unit.

The scales of all barometers used to measure atmospheric pressure should be graduated to hPa. Some barometers are graduated in millimeters (mm Hg) or inches of mercury (in. Hg) under standard conditions. Under these standard conditions (0 degrees C, 760 mm Hg), a column of mercury having a true scale height of 760 mm Hg exerts a pressure of 1,013.250 hPa.

The following conversion factors apply:

$$\begin{aligned}1 \text{ hPa} &= 0.750 \text{ mm Hg} \\1 \text{ in. Hg} &= 33.863 \text{ hPa} \\1 \text{ mm Hg} &= 0.039 \text{ in. Hg}\end{aligned}$$

Where 1 in. = 25.4 mm, the following conversion factors are obtained:

$$\begin{aligned}1 \text{ hPa} &= 0.029 \text{ in. Hg} \\1 \text{ in. Hg} &= 33.863 \text{ hPa} \\1 \text{ mm Hg} &= 0.039 \text{ in. Hg}\end{aligned}$$

7.2 Types of Instrumentation

For air quality and meteorological purposes, atmospheric pressure is generally measured with mercury, aneroid, or electronic barometers. Most, if not all of the atmospheric pressure sensors available provide analog or serial output that is directly interfaced with a data acquisition system.

A mercury barometer measures the height of a column of mercury that is supported by the atmospheric pressure. It is a standard instrument for many climatological observation stations, but it does not afford automated data recording.

An aneroid barometer consists of two circular disks bounding an evacuated volume. As the pressure changes, the disks flex, changing their relative spacing which is sensed by a mechanical or electrical element and transmitted to a transducer.

Most electronic barometers of recent design use transducers which transform the sensor response into a pressure-related electrical quantity in the form of either analog or digital signals. Current digital barometer technology employs various levels of redundancy to achieve long-term stability and accuracy of the measurements. One technique is to use three independently operating sensors under centralized

microprocessor control. Even higher stability and reliability can be achieved by using three completely independent barometers, incorporating three sets of pressure transducers and microprocessors. Each configuration has automatic temperature compensation from internal-mounted temperature sensors. Triple redundancy ensures excellent long-term stability and measurement accuracy, even in the most demanding applications.¹² Figure 7.1 depicts an electronic barometer with three independent transducers.



Figure 7.1 Electronic Barometer. Source:

<http://www.vaisala.com/businessareas/instruments/products/barometricpressure/ptb220>

7.3 Acceptance Testing

New barometers and barometers that have been sent to vendors for maintenance or calibration should be checked for proper operation upon receipt. Damage can occur during shipping and handling that could affect response. The barometric pressure reading from a new or repaired barometer should be compared to the reading from a CTS barometer such as a portable electronic barometer. Figure 7.2 shows a portable digital barometer. To ensure proper operation of a station barometer, multiple pressure readings from the station barometer and the CTS barometer should be compared over a period of several days. The readings should be made with both barometers at the same height and in similar environmental conditions. An electronic barometer with a mean difference from the CTS that exceeds 0.25 hPa should be regarded as unserviceable and returned to the calibration facility for recalibration.



Figure 7.2 Portable Digital Barometer. Source:

<http://www.vaisala.com/businessareas/instruments/products/barometricpressure/ptb220ts>

7.4 Installation and Instrument Exposure

The location of a barometer should be carefully considered in order for the equipment to accurately measure atmospheric pressure. A barometer should be placed in a location

- ▶ That has uniform, constant temperature
- ▶ That has good general lighting but is shielded from direct sunshine
- ▶ That is away from drafts and heaters
- ▶ Where it will have a solid, vertical mounting
- ▶ Where it will be protected against rough handling

Wind can cause dynamic changes in air pressure, therefore causing barometric readings to be inaccurate. Fluctuations from wind are superimposed on the static pressure and, with strong and gusty wind, may amount to 2 or 3 hPa. It is usually impractical to correct for such fluctuations because the “pumping” effect on the mercury surface is dependent on both the direction and force of the wind, as well as on the barometer’s location. Thus the “mean value” will not represent the true static pressure. More information on wind effects is found in Liu and Darkow.⁴¹

It is possible to overcome the effect of wind to a very large extent by inserting a static head between the exterior atmosphere and the inlet port of the sensor. Details concerning the principles of operation of static heads can be found in several publications.^{42,43} The cistern of a mercury barometer must be made airtight except for a lead to a special head exposed to the atmosphere and designed to ensure that the pressure inside is true static pressure. Aneroid and electronic barometers usually have simple connections to allow for the use of a static head which should be located in an open environment not affected by the proximity of buildings.

Air conditioning may create a significant pressure differential between the inside and outside of a room. Therefore, if a barometer is to be installed in an air conditioned room, it is advisable to use a static head with the barometer that will couple the barometer to the air outside the building.

Figure 7.3 shows a small vented environmental enclosure (NEMA 4X) for applications where another suitable shelter is not available. Figure 7.4 shows a tower-mounted barometer with a pressure port to minimize dynamic pressure errors caused by wind.



Figure 7.3 NEMA 4X Enclosure. Source: <http://www.climatronics.com/pdf/products/sensors/102270.pdf>



Figure 7.4 Tower-Mounted Barometer with Pressure Port. Source: <http://www.youngusa.com>

7.5 Calibration

Electronic barometers should be returned to a calibration facility annually for calibration. Upon receipt of a barometer at a meteorological station a comparison test should be run. Pressure readings from an

electronic barometer should be compared to pressure readings from a CTS over a period of several days. The readings should be taken with both barometers at the same height, when the wind is less than 12 m s⁻¹, and when the pressure is either steady or changing by less than 1 mb. An electronic barometer with a mean difference from the CTS that exceeds 0.5 mb should be regarded as unserviceable and returned to the calibration facility for recalibration.

Every six months, readings from an electronic barometer collected over several consecutive hours should be compared to readings from a CTS under similar circumstances; a mean difference should be established. If the mean difference is more than 3 mb, the station barometer should be returned to the manufacturer for calibration.

7.6 Operation and Maintenance

A barometric sensor should meet the specifications listed in the MQO tables in Section 0. The minimum reporting resolution should be 0.1 mb. The data should be at least hourly averaged referenced to local standard time representing the actual hour the data were recorded. If the hourly average does not represent the actual hour, then the data need to be flagged and noted so later comparisons will be accurate.

Routine maintenance procedures should include physical integrity checks of NEMA 4 enclosures to ensure proper ventilation. Signal cables should be in good condition. Indoor sensors should be dusted to prevent dust accumulation on the sensors.

7.7 Auditing

Performance audits should be conducted once a year. A performance audit should entail a comparison of atmospheric pressure sensor readings to a CTS. The elevation settings on the CTS and the sensor should be equivalent to eliminate elevation bias. Pressure readings should be compared once per hour for the duration of time the auditor is on site and a mean difference should be calculated. Audit result acceptance criteria for pass-fail should be ≤ 3 mb.

8. Quality Assurance for Ground-Based Remote Sensing Devices

Over the past few years, developments in remote sensing technology have made it possible to obtain three-dimensional wind velocity (u , v , w) and virtual air temperature (T_v) profiles with the precision and accuracy suitable for regulatory applications. Three types of commercially available remote sensors exist: Sodar (Sound Detection And Ranging), which uses acoustic pulses to measure horizontal and vertical wind profiles; radar (Radio Detection And Ranging), which uses electromagnetic (EM) pulses to measure horizontal and vertical winds; and RASS (Radio Acoustic Sounding System), which uses both acoustic and EM waves to measure T_v . These remote sensors can also provide estimates of the height of the mixed layer and elevated inversions by measuring the parameters listed here. Detailed descriptions of these instruments are included in this section.

Wind. Upper-air wind speeds and wind directions are vector-averaged measurements. None of the measurement systems described in the following sections provides a means to measure winds as scalar quantities, as is done with cup and vane sensors mounted on an instrumented tower. The vertical beam of the remote sensor can measure vertical velocity. Upper-air wind data comprise either point measurements (radiosondes) or volume averages (remote sensors). The altitude at which the winds are reported is assumed to be the midpoint of the layer over which the winds are averaged. Averaging periods for upper-air wind data also vary depending on the instrument system used. The averaging interval for winds measured by Sodars and radar profilers is typically 15-60 minutes.

Virtual Temperature. Upper-air temperature measurements are most commonly obtained using National Weather Service (NWS) radiosonde sounding systems. Radiosonde temperature measurements are point measurements. RASS measures the T_v of the air rather than the dry-bulb temperature (T). The T_v of an air parcel is the temperature that dry air would have if its pressure and density were equal to those of a parcel of moist air, and thus T_v is always higher than the dry-bulb temperature. Under hot and humid conditions, the difference between T_v and T is usually on the order of a few (2-3) degrees C; at low humidity, differences between T_v and T are small. Given representative moisture and pressure profiles, temperature can be estimated from the T_v measurements. RASS temperature measurements are volume averages with a vertical resolution comparable to that of the wind measurements reported by the remote sensing systems (i.e., 60-100 m).

Mixing Height. For the purposes of this guidance, mixing height is defined as the height of the layer adjacent to the ground over which an emitted or entrained inert non-buoyant tracer will be mixed (by turbulence) within a time scale of about one hour or less.⁴⁴ Mixing heights can be estimated using reflectivity profiles from the radar wind profiler and Sodars. In addition, RASS T_v profiles can be used to estimate mixing heights using the Holzworth method.⁴⁵ An in-depth discussion of mixing heights from remote sensors can be found in EPA meteorological monitoring guidance for regulatory modeling applications.⁴

Turbulence. Some Sodars report wind turbulence parameters. In using these parameters, one must remember that Sodars measure the vector components of the wind. Furthermore, there may be significant differences in time and space between the sampling of the components so that any derived variables using more than one component may be affected by aliasing. Thus, the derived turbulence parameters from Sodars are generally not the same parameters that models expect for input. Numerous studies have been performed comparing Sodar-based turbulence statistics with tower-based turbulence statistics. Findings

from these studies have generally shown that measurements of the standard deviation of the vertical component of the wind speed (σ_w) are in reasonable agreement, while the standard deviation calculations incorporating more than one component (e.g., σ_θ) are not.⁴⁶

8.1 Types of Instruments and Specifications

Meteorological remote sensing devices provide measurements without disturbing the environment. In addition, remote sensing measurements are not restricted to a given height as are in situ and tower-based measurements. More importantly, data obtained from a remote sensor is represented as a spatial, or more specifically, a volume average as shown in Figure 8-1. This is a significant difference from the in situ measurements, which are measured directly. This difference has significant implications for calibrations and audits of upper-air measurement systems in Subsections 8.4 and 8.6.

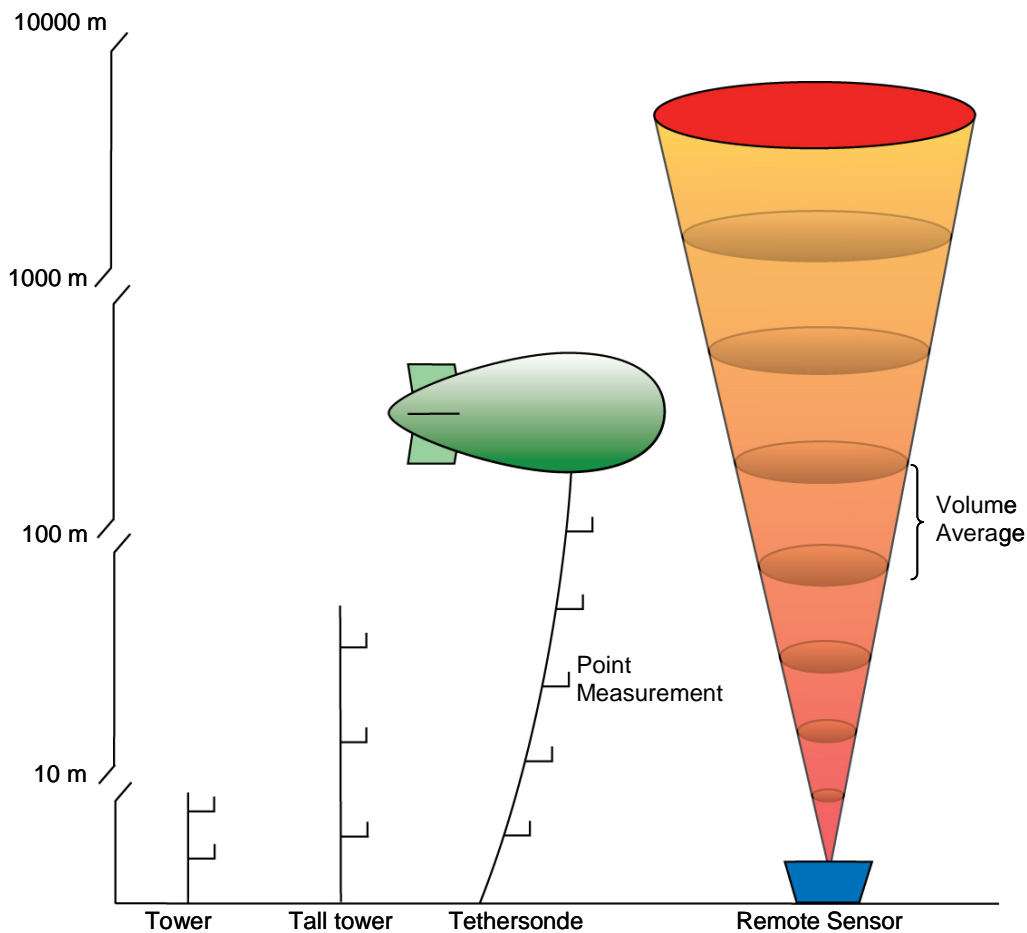

Figure 8.1 Schematic Showing the Differences Between In-Situ (Point) and Remote Sensor (Volume) Measurements

Ground-based meteorological remote sensors have been designed to measure vertical profiles of wind velocity and T_v . The development and evolution of these devices over the last several decades have followed two similar but distinct paths: one based on acoustics and the other on EM radiation. Wind velocities acquired by Sodar are based on the atmospheric effects on the propagation of acoustic energy,

while radars are based on the atmospheric effects on the propagation of electromagnetic energy. Profiles of T_v are obtained by RASS, which combines acoustic and EM technologies. Table 8-1 provides a summary of typical specifications for the three major types of meteorological remote sensing devices.

Table 8-1 Typical Specifications for Meteorological Remote Sensors

Specification ¹²	Mini-Sodar	Sodar	Radar Wind Profiler	RASS
Parameters measured ^a	u,v, w, Z_i	u,v, w, Z_i	u,v, w, Z_i	T_v
Frequency	3–5 KHz	1–3 KHz	915 MHz	2 KHz (sound) ^c 915 MHz (radar) ^c
Minimum height (m) ^b	5–15	10–30	90–120	90–120
Maximum height (m) ^b	100–300	200–2000	1500–4000	500–1500
Vertical resolution (m)	5–20	5–100	60–100	60–100

^a u, v, w are the three components of wind; Z_i is the height of the elevated inversion layer; and T_v is virtual air temperature.

^b Actual altitude coverage will depend on instrument condition and configuration, atmospheric conditions, and siting characteristics.

^c RASS requires both sound and radar technologies. Thus you can add a RASS system to a Sodar by adding a radar, or add RASS to a radar wind profiler by adding a sound source.

The general components and theory of operation with Sodars and radar wind profilers are very similar. These systems have a transmitter to emit the signal, an antenna for transmitting signals, and a receiver to detect a returned signal, and system electronics and software to control the remote sensor. As shown in Figure 8.2, these remote sensors operate by transmitting a signal (sound for Sodar and EM for radar wind profilers) at a known frequency. The signal is sent to the antenna and transmitted upward where it is then scattered by the atmosphere. A small portion of the transmitted signal is scattered back toward the antenna (called backscattering). The receiver measures three properties of the returned signal: (1) the arrival time of the signal which indicates the height (i.e., range), (2) the strength of the backscattered signal, and (3) the Doppler shift, which is the frequency difference between the transmitted and received signals and is directly related to the velocity along the transmitted direction (i.e., beam).

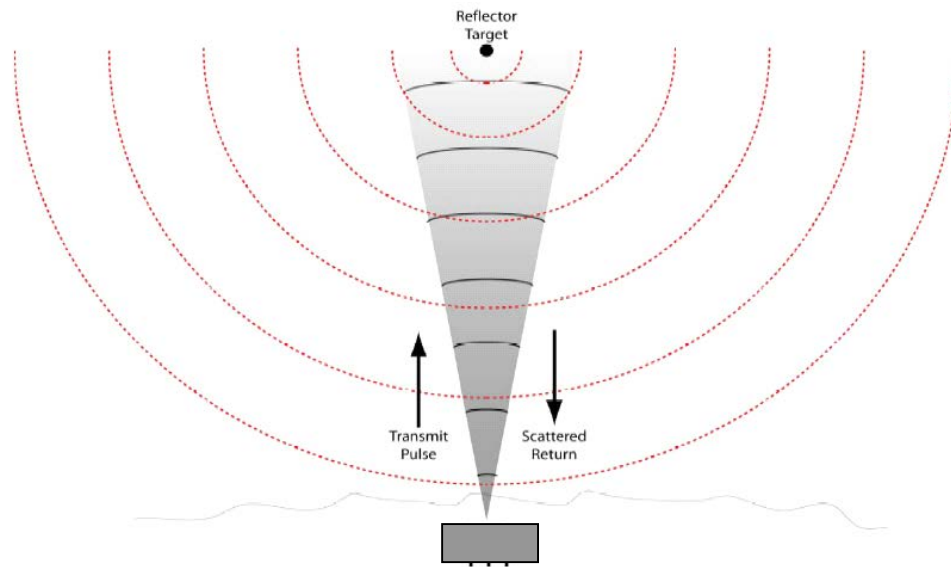

Figure 8.2 Schematic Showing the Transmitted and Received Signals From Sodars, Radar Wind Profilers, and RASS

Sometimes periodic clutter, or interferences by sources such as bugs, birds, or low-flying aircraft, etc., can bias the return signal. These erroneous values are removed by sophisticated algorithms and the remaining data are averaged to provide a profile of measurements. These averages are usually computed for time periods of 10 minutes to 1 hour, depending upon the data recommendations of a particular study and the instruments used.

To compute the wind speed and wind direction, these remote sensors transmit signals along a vertical beam and two (or four) oblique beams (off vertical by 12° to 30°) (Figure 8-3). To create these separate beams, individual antennas are physically tilted in different directions or a phase-array antenna electronically creates vertical and oblique beams. The beam width typically ranges from 2 degrees to 15 degrees. Note that these beams are not perfectly formed as shown in the simplistic schematic, but they include side lobes, or weaker beams, at other angles (Figure 8-4). Sometimes signals returned from the side lobes can bias the measurements.

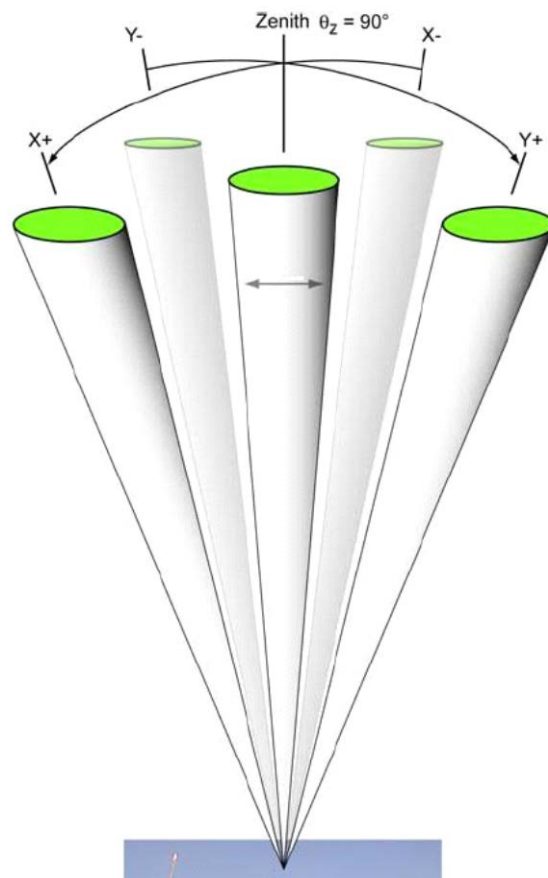

Figure 8.3 Schematic Showing the Vertical and Oblique Beams (Vaisala)

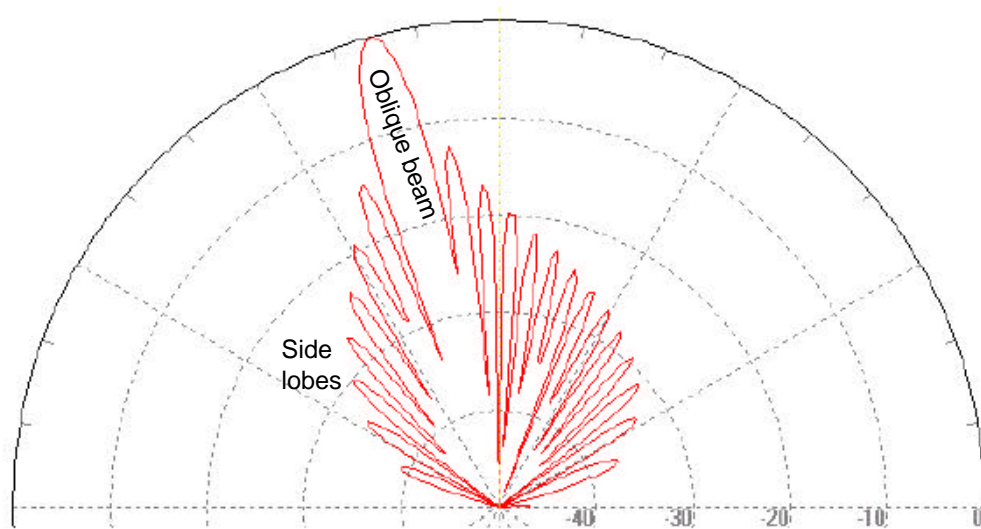

Figure 8.4 Schematic Showing a Beam Pattern for an Oblique Beam and its Associated Side Lobes (Vaisala)

The beams are typically, but not necessarily, oriented at right angles to one another. Ideally, one is directed toward the East or West so that the u component of the horizontal wind velocity can be determined while the other is directed toward the North or South for the v component. The actual orientation of the beams can be toward any direction and is typically decided based on site-specific factors. The mean horizontal and vertical wind velocity components (u , v , and w) can be computed using the following equations:

$$u = \left[- \left(\frac{V_x - V_z \sin(\theta_x)}{\cos(\theta_x)} \right) \sin \phi_x \right] + \left[- \left(\frac{V_y - V_z \sin(\theta_y)}{\cos(\theta_y)} \right) \sin \phi_y \right] \quad (8-1)$$

$$v = \left[- \left(\frac{V_x - V_z \sin(\theta_x)}{\cos(\theta_x)} \right) \cos \phi_x \right] + \left[- \left(\frac{V_y - V_z \sin(\theta_y)}{\cos(\theta_y)} \right) \cos \phi_y \right] \quad (8-2)$$

$$w = -V_z \quad (8-3)$$

where oblique beam 1 has a zenith angle θ_x and azimuth ϕ_x ; oblique beam 2 has a zenith angle θ_y and azimuth ϕ_y , and are at right angles to each other; and V_x , V_y , and V_z are the measured radial velocities.

Normally in calculating the mean wind, time averaging is used to eliminate the effect of variations in the vertical velocity. Some systems correct for mean vertical wind if other than 0 m/s. This is useful, and sometimes required, in situations where the average vertical wind may not be zero (i.e., in complex terrain).

The following subsections in this section describe the theory of operation for the various types of profiling systems that are commercially available, with an emphasis on system specifications. Subsections follow on installation procedures and acceptance testing techniques to ensure that acquired data are reliable and representative of atmospheric conditions. The inherent problems of calibration procedures and performance audits are discussed in detail. Standard operating procedures, maintenance schedules, and quality control (QC) issues are also discussed.

8.1.1 Doppler Sodar

In the late 1960s and early 1970s, remote sensing techniques focused on the development of an acoustic-based wind profiling system, commonly known today as a Sodar. Now these commercially available Sodars are operated for the purpose of collecting upper-air wind measurements for a wide variety of applications. Sodars consist of an antenna(s) that transmit and receive acoustic signals. A monostatic system uses the same antenna for transmitting and receiving, while a bi-static system uses separate antennas. The difference between the two antenna systems determines whether atmospheric scattering by temperature fluctuations (in mono-static systems), or by both temperature and wind velocity fluctuations (in bi-static systems) is the basis of the measurement. The vast majority of Sodars in use are of the monostatic variety due to their more compact antenna size, simpler operation, and generally greater altitude coverage. Figure 8.5 shows the beam configurations of monostatic and bistatic systems.

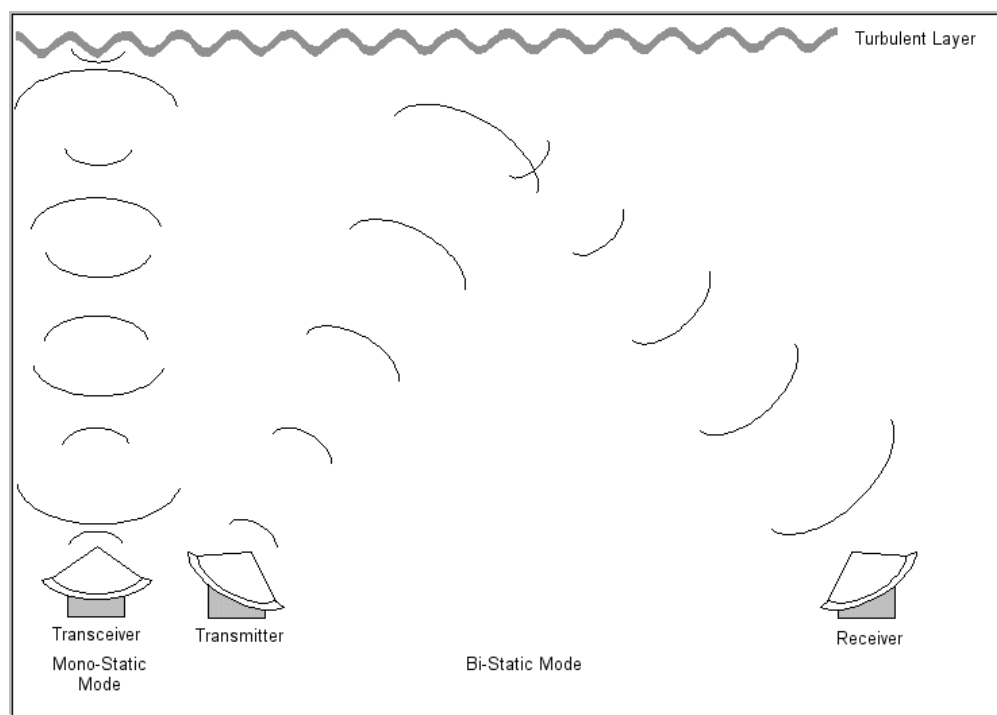

Figure 8.5 Schematic Showing a Monostatic and Bistatic Sodar System

The horizontal components of wind velocity are calculated from the radially measured Doppler shifts. The tilt angle, or zenith angle, is generally 15 degrees to 30 degrees and the horizontal beams are typically oriented at right angles to one another. Since the Doppler shift of the radial components along the tilted beams includes the influence of both the horizontal and vertical components of the wind, a correction for the vertical velocity should be applied in systems with zenith angles less than 20 degrees. In addition, if the system is located in a region where expected vertical velocities may be greater than about 0.2 m/s, corrections for the vertical velocity should be made regardless of the beam's zenith angle.

The vertical range of Sodars is approximately 0.2 to 2 kilometers (km) and is a function of frequency, power output, atmospheric stability, turbulence, and, most importantly, the noise environment in which a Sodar is operated. Operating frequencies range from less than 1,000 Hz to over 4,000 Hz, with power levels up to several hundred watts. Due to the attenuation characteristics of the atmosphere, higher power, lower frequency Sodars will measure to higher altitudes. This greater range comes with a trade-off of coarser vertical resolution when compared to the higher frequency Sodars that provide finer vertical resolution measurements. Some Sodars can be operated in different modes to better match vertical resolution and range to the application.

Another important performance specification for upper-air instrument systems is the data recovery rate. Data recovery is usually calculated as the ratio of the number of observations actually reported at a sampling height to the total number of observations that could have been reported so long as the instrument was operating (i.e., downtime is usually not included in data recovery statistics and is treated separately). Data recovery is usually reported as percent as a function of altitude. Altitude coverage for upper-air data is often characterized in terms of the height up to which data are reported 80 percent of the time, 50 percent of the time, etc. Data recovery of Sodars is highly variable and is dependant on atmospheric conditions at the various sampling heights. With Sodars and radars, it is common to have

several levels of invalid or missing data, usually because there are few targets available for scattering at those levels.

Sodar systems should include available options for maximizing the intended capabilities (e.g., altitude range, sampling resolution, averaging time) of the system and for processing and validating the data. Sodar manufacturers usually have software subroutines that perform a variety of quality assurance/quality control (QA)/QC and display functions. It is important to purchase QA/QC software that provides an extra level of data validation, but one must still assure that valid meteorological data are not filtered out. Software is also available for estimating mixing height and vertical and horizontal turbulence parameters.

Figure 8.6 illustrates different types of Sodar instruments. The selection of an installation site(s) should be made in consultation with the manufacturer and should consider issues associated with the operation of the Sodar instrument. Training should be obtained from the manufacturer on data validation and the installation, operation, and maintenance of the instrument. Additional information on these issues is provided in Section 8.3.

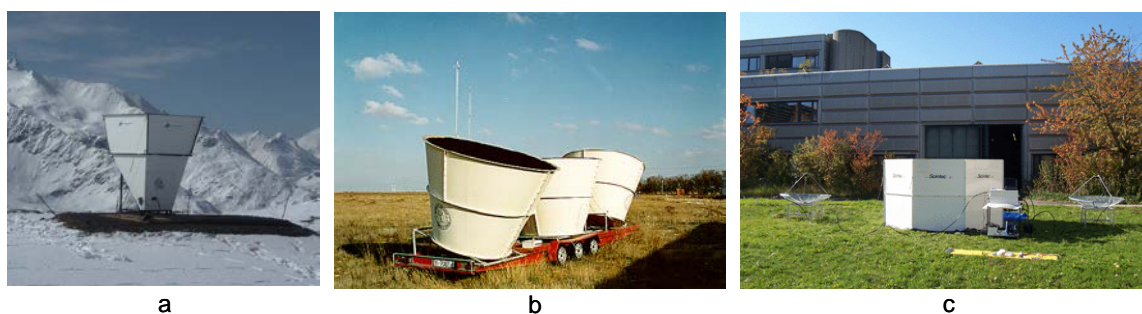

Figure 8.6 Pictures of Different Types of Sodars: (a) Mini-Sodar (Phased Array), (b) Multi-Axis Sodar, (c) Phased-Array Sodar (Flat Horizontal Antenna Array)

8.1.2 Radar Wind Profiler

The principles behind the radar wind profiler are similar to Sodar except radars use EM waves to sense turbulent fluctuations in the atmosphere. Because EM signals do not attenuate (dissipate) as quickly as sound waves, radars have greater vertical range than Sodars. Like Sodars, radar wind profilers have different operating frequencies and corresponding range and resolution specifications (Table 8-2). The guidance provided herein is focused only on boundary layer radar wind profilers. Examples of this instrument are shown in Figure 8.7.

Table 8-2 Characteristics of Radar Wind Profile

Specification	Boundary Layer	Mid-tropospheric	Tropospheric
Frequency class	1000 MHz (915 MHz)	400 MHz	50 MHz
Antenna size (m ²)	3-6	120	10,000
Peak power (kw)	0.5	40	250
Range (km)	0.1 – 5	0.2 – 14	2 – 20
Resolution	60-100	250	150-1,000



Figure 8.7 Photographs of Types of Radar Wind Profilers: (a) Phased-Array System and (b) Fixed-Axis Antenna System

Radar wind profilers operate using principles similar to those used by Doppler Sodars, except that EM signals are used rather than acoustic signals to remotely sense winds aloft. Figure 8.3 shows an example of the geometry of a radar wind profiler. In the illustration, the radar can sample along each of five beams: one is aimed vertically to measure vertical velocity, and four are tilted off-vertical and oriented orthogonally to one another to measure the horizontal components of the air's motion. A radar wind profiler includes subsystems to control the radar's transmitter, receiver, signal processing, and RASS (if provided).

Detailed information on profiler operation has been provided by van de Kamp and Ecklund et.al.;^{47,48} a brief summary of the fundamentals is provided in the following. The source of the backscattered energy (radar “targets”) is small-scale turbulent fluctuations that induce irregularities in the radio refractive index of the atmosphere. The radar is most sensitive to scattering by turbulent eddies whose spatial scale is one-half the wavelength of the radar, or approximately 16 centimeters (cm) for a 915-MHz radar wind profiler.

A profiler's (and sodar's) ability to measure winds is based on the assumption that the turbulent eddies that induce scattering are carried along by the mean wind. The energy scattered by these eddies and received by the profiler is orders of magnitude smaller than the energy transmitted. However, if sufficient samples can be obtained, then the amplitude of the energy scattered by these eddies can be clearly identified above the background noise level, and the mean wind speed and direction within the volume being sampled can be determined.

The radial components measured by the tilted beams are the vector sum of the horizontal motion of the air toward or away from the radar and any vertical motion present in the beam. Using appropriate trigonometry, the three-dimensional meteorological velocity components (u , v , and w), wind speed, and wind direction are calculated from the radial velocities with corrections for vertical motions. A boundary-layer radar wind profiler can be configured to compute averaged wind profiles for periods ranging from a few minutes to an hour.

Boundary-layer radar wind profilers are often configured to sample in more than one mode. For example, in a “low mode,” the pulse of energy transmitted by the profiler may be 60 m in length. The pulse length determines the depth of the column of air being sampled and thus the vertical resolution of the data. In a “high mode,” the pulse length is increased, usually to 100 m or greater. The longer pulse length means that more energy is being transmitted for each sample, which improves the signal-to-noise ratio (SNR) of

the backscattered signal. Using a longer pulse length increases the depth of the sample volume and thus decreases the vertical resolution in the data. The greater energy output of the high mode increases the maximum altitude to which the radar wind profiler can sample, but at the expense of coarser vertical resolution and with an increase in the altitude at which the first winds are measured. When radar wind profilers are operated in multiple modes, the data are often combined into a single overlapping data set to simplify post processing and data validation procedures.

The operating frequencies of all EM devices, including radars, are regulated by the Federal Communications Commission (FCC). The allocated frequency for radar wind profilers for general use in the United States is 915 MHz, however, other permitted operating frequencies do exist. Before operating a radar wind profiler, the user must have a valid frequency allocation authorization. For non-government operators in the United States this frequency allocation can be obtained from: Federal Communications Commission; Experimental Radio Services; P.O. Box 358320; Pittsburgh, PA 15251-5320. Government operators should request approval from the corresponding National Telecommunications and Information Administration branches.

Data recovery of radars, like Sodars, is a function of atmospheric conditions and is highly variable. With radar wind profilers, it is common to have several levels of invalid or missing data. This is typically due to a lack of humidity and insufficient levels in the refractive index in the atmosphere at those heights. During precipitation events, radars measure the fall velocity of the precipitation instead of the air velocity. In these instances, radars may appear to be generating reasonable wind estimates, but the measurements can be biased by the precipitation. Typical data recovery rates range from about 50 percent to near 90 percent and are variable from hour to hour depending on atmospheric conditions.

8.1.3 Radio Acoustic Sounding System (RASS)

The operation principle behind RASS is that Bragg scattering occurs when acoustic energy (i.e., sound) is transmitted into a radar beam such that the wavelength of the acoustic signal matches the half-wavelength of the radar. As the frequency of the acoustic signal is varied, strongly enhanced scattering of the radar signal occurs when the Bragg match takes place. When this occurs, the radar can measure the propagation speed of the sound pulse. Thus, the speed of sound as a function of altitude can be measured, from which T_v profiles can be calculated. The T_v of an air parcel is the temperature dry air would have if its pressure and density were equal to those of a sample of moist air. If not corrected in software, vertical motions can affect RASS T_v measurements. As a rule of thumb, an atmospheric vertical velocity of 1 m/s can alter a T_v observation by 1.6 degrees C.

RASS can be added to a radar wind profiler or to a Sodar system as shown in Figure 8.8a. When RASS is added to a radar profiler, three or four vertically pointing acoustic sources (equivalent to high-quality stereo loud speakers) are placed around the radar wind profiler's antenna. Electronic subsystems are added that include the acoustic power amplifier and the signal-generating circuit boards. The acoustic sources are used only to transmit sound into the vertical beam of the radar, and are usually encased in noise suppression enclosures to minimize nuisance effects that may bother nearby neighbors or others in the vicinity of the instrument.

When RASS is added to a Sodar, as shown in Figure 8.8b, the necessary radar subsystems are added to transmit and receive the radar signals and to process the radar reflectivity information. Since the wind data are obtained by the Sodar, the radar needs only to sample along the vertical axis. The Sodar transducers are used to transmit the acoustic signals that produce the Bragg scattering, which allows the speed of sound to be measured by the radar.

The vertical resolution of RASS data is determined by the pulse length(s) used by the radar. RASS sampling is usually performed with a 60- to 100-m pulse length. Because of atmospheric attenuation of the acoustic signals at the RASS frequencies used by boundary layer radar wind profilers, the altitude range that can be sampled is usually from 0.1 to 1.5 km, depending on atmospheric conditions (e.g., high wind velocities tend to limit RASS altitude coverage to a few hundred meters because the acoustic signals are blown out of the radar beam).

RASS is an optional component of an RWP or Sodar system. The power output of the acoustic source should be kept as high as possible to obtain measurements from the highest altitudes possible.



Figure 8.8 Photographs of (a) a Radar Wind Profiler with a RASS and (b) a Sodar with a RASS

8.2 Acceptance Testing

Acceptance testing should be designed to determine if newly purchased or installed equipment is performing according to the manufacturer's specifications. The acceptance test is crucial for remote sensors since data cannot be easily verified by simple tests. Shortly after the installation and startup of an instrument, a system and performance audit should be performed. These audits will provide information for the qualitative and quantitative assessment of the performance of the system, as well as the adequacy of the standard operating procedures (SOPs) used for collection, processing, and validation of the data. To best ensure that the data collected is of known quality, and that potential problems are identified early, it is recommended that the initial audit be performed within 30 days of the start-up date.

For meteorological remote sensors, an acceptance test should include an intercomparison of data from the system to be tested with data from acceptable in situ sensors on a tall tower, tethered sonde, Sodar, radiosonde, or other remote sensing or measurement system. The test should include the comparisons of data at a minimum of three levels and over a range of meteorological conditions.

Intercomparisons are best performed using collocated meteorological information from tall towers or other upper-air sensors. In the absence of these collocated data sources, nearby upper-air data from the NWS radiosonde network, the NOAA profiler network, aircraft reports, National Center for Environmental Prediction (NCEP) high resolution mesoscale analyses, or other upper-air data can be used. It is important to have an individual trained in the interpretation of the data perform a thorough review of at least several days of data. The qualitative check is not meant to evaluate whether the data meet the manufacturer's data specifications, but is intended to identify problems such as

- ▶ component failures;
- ▶ incorrect or improper operating/sampling parameters;
- ▶ antenna azimuth angles specified improperly or incorrectly measured; and
- ▶ siting problems (active and passive interfering noise sources).

The obvious difficulty encountered in trying to quantify the performance of a remote sensor is that one must assume the “true” state of the atmosphere is known and, therefore, the degree of agreement between profiler observations and reference values provided by independent measurement systems can be determined.² Under the best of circumstances, this requires an assumption of homogeneity and stationarity in the atmosphere during the period in which the intercomparisons are performed. Given the techniques currently available for obtaining data for intercomparisons, a measure of uncertainty is introduced into any data set used to evaluate the remote sensor’s performance. Sources of this uncertainty include

- ▶ Differences in intercomparison data sets due to meteorological variability, spatial separation of measurements, temporal separation of measurements, different sampling techniques and data reduction protocols, and/or outside sources of interference (e.g., radio frequency interference, ground clutter, etc.);
- ▶ Instrument errors; and
- ▶ Random errors.

An important assumption in the acceptance test (and performance audits) is to design and perform tests in such a way that the uncertainties due to all but the last two sources of error, namely instrument errors and random errors, will be minimized. If this goal can be met, then the results of the intercomparison tests will better reflect the real performance of the remote sensor.

We emphasize the concept of “estimating” the accuracy of these remote sensors because a reference instrument capable of providing “true” values of the meteorological variables measured by these instruments does not exist. Uncertainties can be introduced in the data sets being compared by meteorological variability, different sampling protocols, and other environmental and operational factors. For example

- ▶ Radiosondes provide a quasi-instantaneous measurement of winds and temperatures, while the profiler is usually configured to produce data averaged over 15-60 minutes. Changes in meteorological conditions during the averaging period (e.g., wind shift associated with a frontal passage) will be reflected in the profiler data but may not be represented in the radiosonde observations.
- ▶ A profiler samples the column of air directly above the instrument, while a radiosonde drifts with the mean wind. Horizontal gradients in the winds or temperatures over the volume of air sampled by the radiosonde may not be represented in the profiler data.
- ▶ Even with the radar wind profiler and collocated Sodar, their respective geometries and sampling configurations can introduce uncertainties into the data sets when there are in-homogeneities between the volumes of the atmosphere each is sampling.

The test methods listed here can be used to perform an acceptance test and are designed to minimize differences caused by these and other factors. The seven basic steps to performing a quantitative intercomparison are

1. Plan to conduct the intercomparison under a variety of atmospheric conditions (during stable, convective, and transitional boundary layers and weak, moderate, and strong winds).
2. Configure the instruments to make comparable measurements so that uncertainties due to meteorological variability, sampling techniques, and data reduction protocols are minimized. Alternatively, post-processing may be required to average the data so that the time and/or space (altitude) scales of the two data sets are comparable.
3. Ensure the comparison instrument does not interfere with the remote sensor (e.g., tethersonde in the beam of the Sodar or radar).
4. Document the weather conditions during the intercomparison by logging standard hourly observations, including current weather, ceiling, sky-cover, ambient temperature, wind speed and wind direction.
5. Collect enough samples so that the conditions of interest are well represented.
6. Perform quality control screening on all data to be used in the intercomparisons. All observations should be brought to Level 1 validation before quantitative tests are performed.
7. Compute comparison statistics shown here and compare the results with those criteria listed in Table 8-2.

The following statistics can be used to compare profiler observations to other data sets and to estimate the performance of the profiler. We recommend that these parameters be computed for the ensemble of the data and as a function of altitude.

Systematic difference²⁴ used as a measure of the relative accuracy of the instrument:

$$d = \frac{1}{n} \sum (P_{a,i} - P_{b,i}) \quad (8-5)$$

where n = number of observations

$P_{a,i}$ = i th observation of the sensor being evaluated

$P_{b,i}$ = i th observation of the “reference” instrument

Operational comparability^{24,22}, or the rms difference between the remote sensor and comparison measurements, used as a measure of the uncertainties in the comparisons.

$$c = \sqrt{\frac{1}{n} \sum (P_{a,i} - P_{b,i})^2} \quad (8-6)$$

These statistical calculations should be performed on both the vector and component values along the remote sensor antenna axes. Computations are made along the antenna axes to help identify any antenna-specific issues such as reflections or active noise sources.

Some general guidelines for making data as similar as possible include

- The data from the tethersonde or tower should be broken down into their u and v components. At the end of this sampling period, the components should be averaged and the resultant vector wind speed and wind direction calculated.

- ▶ At some sites it may be possible to use NWS radiosonde data to perform an acceptance test. This test is somewhat more difficult to perform but will provide the data required to complete the test. The radiosonde should be within 20 km of the remote sensing site, in simple terrain, and in the same meteorological regime as that of the remote sensing instrument. The comparison should include a data time series long enough to have a large sample for every meteorological condition experienced at the site, and only data captured during similar meteorological regimes at both sites should be used in the comparison. Data at higher elevations should be used for the comparison since it is less influenced by local surface features.
- ▶ All wind data used in the intercomparisons should receive quality control screening.
- ▶ Sample during non-precipitating conditions. There may be large discrepancies in winds measured during precipitation because the radar profilers will measure the fall velocity associated with the precipitation, which in turn will be used to extract the horizontal components from the vertical velocities.
- ▶ With radiosondes, match the wind averaging interval you specify in the radiosonde data acquisition system to the balloon's ascent rate so that the radiosonde data are averaged over a volume that approximates as closely as possible the volume sampled by the radar wind profiler and RASS. For example, a 3-m/s ascent rate and a 30-second wind averaging period will produce radiosonde data averaged over layers 90 m deep, which can then be compared to profiler data with a 100-m vertical resolution.
- ▶ To maximize RASS altitude coverage and to minimize uncertainties between the RASS and radiosonde data sets due to meteorological variability and spatial in-homogeneities in the atmosphere, select sampling conditions characterized by light winds (e.g., wind speeds less than 5 m/s) and good vertical mixing.
- ▶ To minimize uncertainties created by temporal differences between the RASS and radiosonde measurements, launch the balloon at the beginning of the RASS sampling period. To minimize spatial differences, launch the balloon as close to the RASS as possible.

8.3 Installation and Siting

The following subsections provide information on installation issues related to QA/QC concerns. In general, it is recommended that the installer follow guidance provided in “On-Site Meteorological Program Guidance for Regulatory Modeling Applications”,⁴ Section 3.0, and vendors’ instructions. In general, installation procedures for all these remote sensors include the following:

- ▶ Determine the latitude, longitude, and elevation of the site using a GPS instrument. The WGS84 coordinate system⁴⁹ is recommended.
- ▶ Measure the orientation of antennas of the Sodar or radar profiler with respect to true north. Use the solar siting technique or the GPS techniques discussed in Sections 2.5.2.3 and 2.5.2.4.
- ▶ The site should be documented as follows:
 - Photographs should be taken in sufficient increments to create a documented 360° panorama around the antennas. Additionally, pictures should be obtained of the antenna installation, shelter and any obstacles that could influence the data.
 - Photographs should be taken of the instrument, site, shelter, and equipment and computers inside the shelter.

- A detailed site layout diagram should be prepared that identifies true north and includes the locations of the instrument, shelter, other equipment, etc. An example of such a diagram is shown in Figure 8.9. Additionally, it is recommended that the site layout diagram include the electrical and signal cable layout, and the beam directions of any remote sensor.
- A vista table should be prepared that documents the surroundings of the site in 30° increments. Vistas for the beam directions, if they are not represented by the 30° views ($\pm 5^\circ$), should be included. The table should identify any potential passive and active noise sources in each direction, and the approximate distance and elevation angle above the horizon to the objects. An example is shown in Figure 8.10.

VISTA, ORIENTATION, AND LEVEL AUDIT RECORD			
Date:	January 3, 1996	Site Name:	5
Key Person:	Jon Sitetech	Project:	ABC
Instrument:	Radar Wind Profiler	Latitude:	31°10'25"
Model Number:	GEN-1500	Longitude:	91°15'33"
Serial Number:	1234	Elevation:	172m
Software Version:	3.95		
Rotation angle		Direction::	
System:	147°true	Beam 1	146°
Measured:	146°true	Beam 2:	236°
Difference:	1°		
Array Level	<0.5°	Firing order:	W,beam 1, beam 2
		Declination:	11°east (solar verification)
AZIMUTH ANGLE (DEG)			
Magnetic	True	Terrain Elevation Angle (deg)	Features/Distance
	0	12	Building and power lines at ~300m
	30	19	Stack at 150-200m
	60	22	Power pole at 10m, <5° beyond
	90	4	Low trees and bushes at 10 m
	120	15	Power lines at 200-300m
	150	4	Trees at 30-40m
	180	0	Looking out over the lake
	240	<2	Looking out over the lake, can see land
	270	<2	Looking out over the lake, can see land
	300	3	Trees an telephone pole at 100m
	330	14	Light pole at 25m. Buildings at ~250m.

Figure 8.9 Example Site Layout Diagram

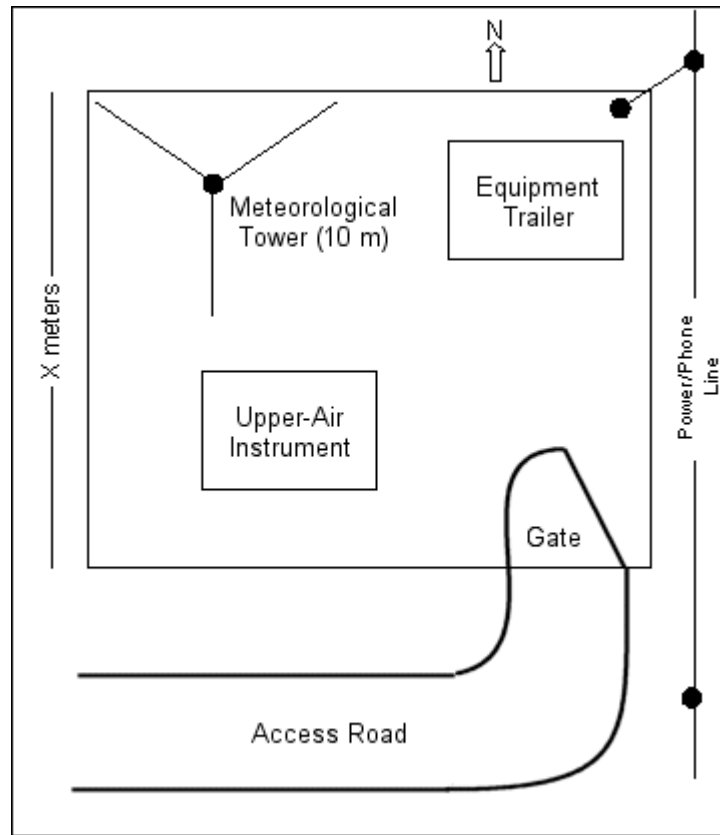

Figure 8.10 Example Site Vista Diagram

Listed below are some key issues to consider when siting upper-air systems.

Representative location. Sites should be located where upper-air data are needed to characterize the meteorological features important to meeting the program objectives. Panoramic photographs should be taken of the site to aid in the evaluation of the data and preparation of the monitoring plan. Data collected at sites in regions with local geographic features such as canyons, deep valleys, etc., may be unrepresentative of the surrounding area and should be avoided, unless such data are needed to resolve the local meteorological conditions. Measurements made in complex terrain may be representative of a much smaller geographic area than those made in simple homogeneous terrain. See Thuillier (1995)⁵⁰ for a discussion of the influence of terrain on siting and exposure of meteorological instrumentation.

Site logistics.

- ▶ Adequate power should be available for the instrument system as well as an environmentally controlled shelter that houses system electronics, and data storage and communication devices.
- ▶ The site should be in a safe, well lit, secure area clear of obstacles with level terrain and sufficient drainage. The site should allow adequate room for additional equipment that may be required for calibrations, audits, or supplementary measurements.
- ▶ A fence should be installed around the equipment and shelter to provide security, and appropriate warning signs should be posted as needed to alert people to the presence of the equipment.

- ▶ A remote data communications link (e.g., dedicated leased line, standard dial-up modem line, Internet link, or satellite Internet) should be installed at the monitoring site.

Collocation with surface meteorological measurements. Several advantages can be gained by locating an upper-air site with or near an existing meteorological monitoring station. For instance, collocated data can be used for data validation purposes and for performing reasonableness checks (e.g., do surface winds roughly agree with near-surface upper-air winds, surface temperatures with near-surface RASS measurements).

Instrument noise. Sodar and RASS generate noise that can disturb nearby neighbors. Depending on the type of Sodar or RASS instrument, power level, frequency, acoustic shielding around the system, and atmospheric conditions, the transmitted pulse can be heard from tens of meters up to a kilometer away. An optimum site is one that is isolated from acoustically sensitive receptors.⁵¹

Passive interference/noise sources. Objects such as stands of trees, buildings or tall stacks, power lines, towers, guy wires, vehicles, birds, or aircraft can reflect Sodar or radar signals and contaminate the data. Not all sites can be free of such objects, but an optimum site should be selected to minimize the effects of such obstacles. If potential reflective “targets” are present at an otherwise acceptable site, the beams of the instrument should be aimed away from the reflective objects. In the case of Sodars, locating the antennas so that there are no direct reflections from objects will help minimize potential contamination. In the case of the radar profiler, it is best to aim the antennas away from the object and orient a phased-array antenna’s corners so they are pointing toward the objects. As a rule of thumb, sites with numerous objects taller than about 15° above the horizon should be avoided. The manufacturers of the remote sensing equipment should be contacted regarding software that may be available to identify and minimize the effects of these passive noise sources.

Active interference/noise sources. For Sodars, noise sources such as air conditioners, roadways, industrial facilities, animals, and insects will degrade the performance of Sodar systems.⁵¹ If proximity to such sources cannot be avoided, then additional acoustic shielding may help minimize the potentially adverse effects on the data. In general, noise levels below 50 decibels (dBA) are considered to be representative of a quiet site, while levels above 60 dBA are characteristic of a noisy site. For radar wind profilers and RASS, radio frequency (RF) sources such as radio communications equipment and cellular telephones may have an adverse effect on performance. A radio frequency scanner is helpful for identifying these sources.

Licenses and ordinances. Before operating a remote sensor, it is recommended that all applicable recommendations for operation of equipment be addressed. For example, to operate a radar wind profiler or a RASS, an FCC license is required. For radiosonde and tethered sounding systems, a Federal Aviation Administration (FAA) waiver may be required. Local noise ordinances may limit the operation of Sodar or RASS instruments. Some of these requirements may take several months to address and complete.

Surveying candidate locations. Prior to final site selection, a survey is recommended to identify audio sources⁵² and RF sources that may degrade system performance. Additionally, panoramic photographs should be taken to aid in the evaluation of the candidate site and for the preparation of the monitoring plan. As part of the survey, appropriate topographic and other maps should be used to identify other potential sources of interference, such as roadways and airports.

Specific installation procedures for each instrument are presented in the following sections.

8.3.1 Sodar

Siting of Sodars can best be accomplished by vendors or experienced users. The complexities of Sodars provide a challenge to the user who must optimize the conditions favorable for Sodar technology while still making use of available sites in a given study area.

A problem may exist at some potential monitoring sites due to the presence of passive and active noise sources. It is extremely important to determine if the proposed sampling site has any potential for producing fixed echoes (a passive noise source). These fixed echoes are often due to the energy contained in the side lobes of the emitted acoustic pulse. These fixed echoes may have the effect of biasing the computed wind components u , v , and w . Printing a facsimile chart sometimes reveals the presence of fixed echoes. This should be performed shortly after system setup, and repeated seasonally to aid in determining if fixed echoes exist. Some fixed echoes may be avoided by constructing an acoustically absorbing shelter around the Sodar antennas. These shelters are designed to absorb most of the energy released in the side lobes, minimizing the potential for reflections.

Additional guidance includes the absence of obstructions in a 110° arc centered on the vertical axis or a 40° arc centered on each beam. In addition, if the system is to be installed near a building, the antennas should be oriented off the corners of the building. If the building does intercept the sound wave, the wave will be reflected away from the Sodar due to the acute angles of the building's wall. Some manufacturers provide software routines that can detect fixed echoes and eliminate them from the consensus output.

All attempts should be made to avoid fixed echoes; however, if a limited number of sites are available and all have a possibility of producing fixed echoes, then the fixed echo detection software should be used to eliminate the problem. Special attention should be used during the acceptance test, described in Section 8.2, to determine if the fixed echo rejection routines are working properly.

The antenna does not necessarily have to point in one of the cardinal directions (i.e., north, south, east, or west). System software allows the Sodar to be set up in almost any direction, allowing the installer to point the beams away from obstacles that might interfere with the signal. For example, if the Sodar is to be set up near a tower, the antenna should be oriented so the beams point away from the tower,

Another type of interference, active interference, occurs from objects that emit noise, such as local automobile traffic, nearby construction, overhead aircraft, etc. Any acoustic source that emits its energy near the transmission frequency of a Sodar has the potential to interfere with and degrade data quality. This type of interference is more difficult to detect because it tends to be seasonal, sporadic, or random in nature. This problem can be reduced by installing acoustic absorbing shelters around the Sodar antenna like those shown in Figure 8.6. A simple test to determine if a problem exists at a given site is to set up the Sodar and turn off the transmitter. Analysis of received energy will determine if the presence of active interfering noise exists. If interferences from active sources are detected, it is recommended that the Sodar be moved to an alternate site. The vendor or an experienced Sodar operator should be consulted during the installation process to decrease the chance of contamination of these data.

8.3.2 Radar Wind Profiler

As with a Sodar, careful siting will result in a site that has minimal interferences that can cause data problems. The vendor or an experienced radar wind profiler operator should be consulted during the installation process to decrease the chance of contamination of these data.

Signal returns from “ground clutter” may bias the radar wind profiler data. Trees, power lines, busy roads, and even terrain features can produce erroneous data due to reflected EM signals. Severe ground clutter often degrades the signal enough to render data in the first few reported levels useless. As with Sodars, radar beams have side lobes that emit energy to around 70° from vertical (Figure 8.4). These side lobes cause a higher degree of interference than Sodars because radar return signals are typically very weak, so small amounts of energy reflected back to the receiver may cause large errors in the estimates of wind.

Therefore, radars should be setup away from tall buildings, power lines and other obstructions that may be a potential source of interference. The radar wind profiler should also be situated in an open area (e.g., an airport), or on top of a small hill or building to decrease the potential for ground clutter contamination. The antenna does not necessarily have to point in the cardinal directions (i.e., north, south, east, or west). System software should allow the radar to be set up in almost any direction, allowing the installer to point the beams away from obstacles that might interfere with the signal. For example, if the radar is to be setup near a tower, the antenna should be oriented so the beams point away from the tower.

8.3.3 Radio Acoustic Sounding System

The user of a radar/RASS should follow the guidelines for installing a radar, as specified in Section 8.3.2. Contamination from external acoustic sources is only a minor problem, but should be avoided as outlined for Sodars in Section 8.3.1. If a Sodar/bistatic radar is being used to measure T_v , then the installer should follow the guidelines for installing a Sodar, with the addition of meeting the recommendations for installing a radar profiler.

8.4 Calibration

A calibration involves measuring the conformance to or discrepancy from a specification for an instrument and an adjustment of the instrument to conform to the specification. In this sense, other than directional alignment checks of the antenna(s), a true calibration of the Sodars, radar wind profilers, and RASS instruments described in this document is difficult. Due to differences in measurement techniques and sources of meteorological variability, direct comparison with data from other measurement platforms is not adequate for a calibration. Instead, a calibration of these sensors consists of test signals and diagnostic checks that are used to verify that the electronics and individual components of a system are working properly. Other than antenna misalignment, results from these calibrations should not be used to adjust any data.

System calibration and diagnostic checks should be performed at six-month intervals, or in accordance with the manufacturer's recommendations, whichever is more frequent. The alignment of remote sensing antennas, referenced to true north, should be verified at six-month intervals.

Recent advances in instrumentation for auditing of Sodar instruments⁵³ have led to the development of a transponder that can simulate a variety of acoustic Doppler-shifted signals on certain Sodars. This transponder can be used to verify the calibration of the Sodar's total system electronics and, in turn, validate the overall system operation in terms of wind speed and altitude calculations. However, such a check should not be considered a “true” calibration of the system since it does not consider other factors that can affect data recovery. These factors include the system signal-to-noise ratio, receiver amplification levels, antenna speaker element performance, beam steering and beam forming for phased-array systems, and overall system electronic noise.

For the radar wind profiler and RASS systems, there are no simple means at present to verify the accuracy of the Doppler-shifted signals in the field other than to perform an intercomparison of data with some other measurement system. Instead, calibrations of radar wind profiler and RASS systems are performed and checked at the system component level. These checks should be performed in accordance with the manufacturer's recommendations. Like some Sodars systems, the radar systems use both software and hardware diagnostics to check the system components.

8.5 Operation, Maintenance, and Quality Control

Sodars, radar wind profilers, and RASS have automated operating systems and generally require minimal input from the user. Variables such as vertical range, vertical resolution, averaging times, and power output may be adjusted if needed, but most of the system operations are automatic. Users should follow the vendor's instructions for operation and maintenance.

Like all monitoring equipment, upper-air instruments require various operational checks and routine preventive maintenance. The instrument maintenance manuals should be consulted to determine which checks to perform and their recommended frequency. The quality and quantity of data obtained will be directly proportional to the care taken in ensuring that the system is routinely and adequately maintained. The site technicians who will perform preventive and emergency maintenance should be identified. The site technicians serve a crucial role in producing high quality data and thus should receive sufficient training and instruction on how to maintain the equipment. Some general issues related to operational checks and preventive maintenance should be addressed in the QAPP, including

- ▶ Identification of the components to be checked and replaced
- ▶ Development of procedures and checklists to conduct preventive maintenance
- ▶ Establishment of a schedule for checks and preventive maintenance
- ▶ Identification of persons (and alternates) who will perform the checks and maintenance
- ▶ Development of procedures for maintaining spare components that need frequent replacement

Listed here are some key items to be included in the operational checklists for each of the different types of remote sensors. The list is not comprehensive, but should serve as a starting point for developing a more thorough set of instrumentation checks:

- ▶ Safety equipment (first aid kit, fire extinguisher) should be inventoried and checked.
- ▶ Computers should be routinely monitored to ensure adequate disk space is available, and diagnosed to ensure integrity of the disk.
- ▶ A visual inspection of the site, shelter, instrument and its components should be made.
- ▶ Data should be backed up on a routine basis.
- ▶ If the remote sensors are operated during the winter, procedures for snow and ice removal should be developed and implemented, as needed.
- ▶ The clock time of the instruments should be monitored, and a schedule for updating the clocks established, based on the timekeeping ability of the instrument.
- ▶ The antenna level and orientation of Sodars, radar wind profiler, and RASS systems should be verified periodically.

- ▶ The inside of the antennas/enclosures of the Sodar, radar wind profiler, and RASS systems should be inspected and any leaves, dust, animals, insects, snow, ice, or other materials removed. Since the antennas are open to precipitation, drain holes are provided to allow water to pass through the bottom. These holes should be periodically inspected and cleaned.
- ▶ Cables and guy wires securing the equipment should be checked to ensure that they are tight and in good condition.
- ▶ Antenna cables and connections should be inspected for signs of damage due to normal wear, moisture, or animal activities.
- ▶ For Sodar systems, the site technician(s) should listen to ensure that the system is transmitting on all axes and in the correct firing sequence. For three-axis systems, this is accomplished by listening to each antenna. For phased-array systems, this can be accomplished by standing away from the antenna in the direction of each beam and listening for relatively stronger pulses.
- ▶ The integrity of any acoustic enclosures and acoustic-absorbing materials should be inspected. Weathering of these items will degrade the acoustic sealing properties of the enclosure and reduce the performance.
- ▶ For a radar profiler with RASS, acoustic levels from the sound sources should be measured using a sound meter (ear protection is required) and readings should be compared with manufacturer's guidelines.
- ▶ After severe or inclement weather, the site should be visited and the shelter and equipment should be inspected.

SOPs should be developed that are specific to the operations of a given instrument and site. The purpose of an SOP is to spell out operating and QA procedures with the ultimate goal of maximizing data quality and data capture rates. Operations should be performed according to a set of well-defined, written SOPs with all actions documented in logs and on prepared forms. SOPs should be written in such a way that if problems are encountered, instructions are provided on actions to be taken. At a minimum, SOPs should address the following issues:

- ▶ Installation, setup, and checkout
- ▶ Site operations and calibrations
- ▶ Operational checks and preventive maintenance
- ▶ Data collection protocols
- ▶ Data archiving
- ▶ Key contacts

Some general guidelines for operation and maintenance include

- ▶ Wind data should be stored in their original component values (along the antenna axes), in addition to the storage of the calculated vector quantities. If the system does not support this mode, it is recommended that this quantity be recalculated during the validation process. This guideline will also be useful when the wind direction may be in question.
- ▶ Statistics about the quality of data averages (e.g., number of valid return intensities, consensus numbers, and standard deviation of component values) should also be stored. This information may be useful in detecting instrumentation problems.

- ▶ In addition to storing the averaged wind or Tv data, it is recommended that users store the raw forms of data so they can be reprocessed.
- ▶ The hard-disk drive is used for storing data; it should be checked as often as is necessary to ensure there is enough available storage.
- ▶ In the first few weeks after installation, the data should be checked on a daily basis to determine if the system is working properly. Time series plots of all variables should be produced and analyzed by a meteorologist or other qualified professional. This step is important for detecting any bias or anomalies in the data set. It is usually at this point that active and passive interferences are detected.
- ▶ All inspections and maintenance activities should be documented in a site log book.
- ▶ After the site operator determines the system to be operating adequately, data should be plotted and checked on a weekly or more frequent basis to monitor the system performance.

Maintenance should include biweekly checks of the instrument, site, shelter, and electronics.

All operational checks and preventive maintenance activities should be recorded in logs and/or on appropriate checklists (electronic and/or paper), which will become part of the documentation that describes and defends the overall quality of the data produced.

If problems are found, a corrective action should be taken and reported. A corrective action program must have the capability to discern errors or defects at any point in an upper-air monitoring program. It is an essential management tool for coordination, QC, and QA activities. A workable corrective action program must enable the identification of problems, establish procedures for reporting problems to the responsible parties, trace the problems to the source, plan and implement measures to correct the problems, maintain documentation of the results of the corrective process, and resolve each problem. The overall documentation associated with the corrective action and reporting process will become part of the documentation that describes and defends the overall quality of the data produced. A sample correction form can be found in the EPA's Quality Assurance Handbook for Air Pollution Measurement Systems.⁵⁴

Systematic routines used to inspect these data provide a level of QC. These QC checks should be performed by a technician, meteorologist, or other qualified professional who is familiar with these instruments. When a problem is found, a discrepancy report should be issued that notifies the users of the problem.

Studies performed to date have indicated that the upper-air measurement systems described in this document can reliably and routinely provide high quality meteorological data. However, these are complicated systems and, like all such systems, are subject to sources of interference and other problems that can affect data quality. Users should read the instrument manuals to obtain an understanding of potential shortcomings and limitations of these instruments. If any persistent or recurring problems are experienced, the manufacturer or someone knowledgeable about instrument operations should be consulted.

Sodar data can be rendered problematic by the following:

- ▶ Passive noise sources (also called fixed echo reflections). Passive noise occurs when nearby obstacles reflect the soar's transmitted pulse. Depending on atmospheric conditions, wind speed, background noise, and signal processing techniques, the fixed echoes may reduce the velocity measured along a beam(s) or result in a velocity of zero. This problem is generally seen in the

resultant winds as a rotation in direction and/or a decrease in speed at the affected altitude. Some manufacturers offer systems that have software designed to detect fixed echoes and minimize their influence. To further decrease the effect of the fixed echoes, additional acoustic shielding can be added to the system antenna.

- ▶ Active noise sources (ambient noise interference). Ambient noise can come from road traffic, fans or air conditioners, animals, insects, strong winds, etc. Loud broad-spectrum noise will decrease the SNR of the Sodar and decrease the performance of the system. Careful siting of the instrument will help minimize this problem.
- ▶ Unusually consistent winds at higher altitudes. Barring meteorological explanations for this phenomenon, the most common cause is a local noise source that is incorrectly interpreted as a “real” Doppler shift. These winds typically occur near the top of the operating range of the Sodar. To identify this problem, allow the Sodar to operate in a listen-only mode without a transmit pulse to see if winds are still reported. In some cases, it may be necessary to make noise measurements in the specific operating range of the Sodar to identify the noise source. This may be performed by collecting sound samples and analyzing them with appropriate spectral software.
- ▶ Reduced altitude coverage due to debris in the antennas. In some instances, particularly after a precipitation event, the altitude coverage of the Sodar may be significantly reduced due to debris in the antennas. In three-axis systems, drain holes may become plugged with leaves or dirt and water, snow, or ice may accumulate in the antenna dishes. Similarly, some of the phased-array antenna systems have the transducers oriented vertically and are open to the environment. Blocked drain holes in the bottom of the transducers may prevent water from draining. Regular maintenance can prevent this type of problem.
- ▶ Precipitation interference. Precipitation, mostly rain, may affect the data collected by Sodars. During rainfall events, the Sodar may measure the fall speed of drops, which will produce unrealistic winds. In addition, the sound of the droplets hitting the antenna can increase the ambient noise levels and reduce the altitude coverage.
- ▶ Low signal-to noise-ratio (SNR). Conditions that produce low SNR can degrade the performance of a Sodar. These conditions can be produced by high background noise, low turbulence, and near-neutral lapse rate conditions.

Data from radar wind profiler systems can be affected by several problems, including the following:

- ▶ Interference from migrating birds. Migrating birds can contaminate radar wind profiler signals and produce biases in the wind speed and direction measurements.⁵⁵ Birds act as large radar “targets”, so that signals from birds overwhelm the weaker atmospheric signals. Consequently, the radar wind profiler measures bird motion instead of, or in addition to, atmospheric motion. Migrating birds have no effect on RASS. Birds generally migrate year round along preferred flyways, with the peak migrations occurring at night during the spring and fall months.⁵⁶ Vendors have software to minimize the influence of migrating birds on radar wind profiler data.
- ▶ Precipitation interference. Precipitation can affect the data collected by radar profilers operating at 915 MHz and higher frequencies. During precipitation, the radar profiler measures the fall speed of rain drops or snow flakes. If the fall speeds are highly variable during the averaging period (e.g., convective rainfall), a vertical velocity correction can produce erroneous data.
- ▶ Passive noise sources (ground clutter). Passive noise interference is produced when a transmitted signal is reflected off an object instead of the atmosphere. The types of objects that reflect radar signals are trees, elevated overpasses, cars, buildings, airplanes, etc. Careful siting of the instrument can minimize the effects of ground clutter on the data. Both software and hardware

techniques are also used to reduce the effects of ground clutter. However, under some atmospheric conditions (e.g., strong winds) and at some site locations, ground clutter can produce erroneous data. Data contaminated by ground clutter can be detected as a wind shift or a decrease in wind speed at affected altitudes. Additional information is provided by Brewster and Gaynor.^{47,57}

- ▶ Velocity folding or aliasing. Velocity folding occurs when the magnitude of the radial component of the true air velocity exceeds the maximum velocity that the instrument is capable of measuring, which is a function of sampling parameters.⁵⁸ Folding occurs during very strong winds (>20 m/s) and can be easily identified and flagged by automatic screening checks or during the manual review.

RASS systems are susceptible to several common problems including the following:

- ▶ Vertical velocity correction. Vertical motions can affect the RASS virtual temperature measurements. Virtual temperature is determined by measuring the vertical speed of an upward-propagating sound pulse, which is a combination of the acoustic velocity and the atmospheric vertical velocity. If the atmospheric vertical velocity is non-zero and no correction is made for the vertical motion, it will bias the temperature measurement. As a rule of thumb, a vertical velocity of 1 ms⁻¹ can alter a virtual temperature observation by 1.6 degrees C.
- ▶ Potential cold bias. Recent inter-comparisons between RASS systems and radiosonde sounding systems have shown a bias in the lower sampling altitudes.⁵⁹ The RASS virtual temperatures are often slightly cooler (-0.5 to -1.0°C) than the reference radiosonde data.

8.6 Auditing

A system audit is intended to independently assess the QAPP and how it is being implemented. A performance audit is a direct challenge to the performance of the instrument. Audits of upper-air instrumentation pose some interesting challenges to verifying their proper operation. While system audits can be performed using traditional system checks and alignment and orientation techniques, performance audits of some instruments require unique, and sometimes expensive, procedures. In particular, unlike surface meteorological instrumentation, the upper-air systems cannot be challenged using known inputs such as rates of rotation, orientation directions, or temperature baths. Recommended techniques for both system and performance audits of the upper-air instruments are described here. These techniques have been categorized into system audit checks and performance audit procedures for Sodars, radar profilers, and RASS. Performance audits should be performed 30 days after installation and annually thereafter.

Results from the performance evaluation should be compared with evaluation criteria to assess whether the comparisons are reasonable. Typical criteria for the comparisons are provided in Table 8-3. Comparison results in excess of the criteria do not necessarily mean that the remote sensor data are invalid. In making the assessment, it is important to understand the reasons for the differences. Reasons may include unusual meteorological conditions, differences due to sampling techniques and data reduction procedures, insufficient number of samples, or problems or limitations in one or both instruments. Both the reasons for, and the magnitude of, the differences as well as the anticipated uses of the data need to be considered in determining whether the observed differences are significant.

Table 8-3 Recommended Audit Criteria for Sodar, Radar Wind Profilers, and RASS

Variable	Systematic Difference	Operational Comparability
u, va	±1 m/s	2 m/s
Wind speed ^a	±1 m/s	2 m/s
Wind direction ^a	±10°	30°
RASS temperature	±1°C	1.5°C

^a The wind speed and wind direction criteria apply to data when the wind speeds are greater than 2 m/s.

8.6.1 System Audits of Remote Sensors

System audits of a remote sensor should include a complete review of the QAPP, any monitoring plan for the station, and the station’s SOPs. The system audit will determine if the procedures identified in these plans are followed during station operation. Deviations from the plans should be noted and an assessment made as to what effect the deviation may have on data quality. To ensure consistency in the system audits, a checklist should be used.

A routine check of the monitoring station should be performed to ensure that the local technician is following all SOPs. In addition to specific checks recommended by the vendor, the following items should be checked:

- ▶ The antenna and controller interface cables should be inspected for proper connection. If multi-axis antennas are used, this will include checking for the proper direction of the interface connections.
- ▶ Orientation checks should be performed on the individual antennas, or phased-array antenna. The checks should be verified using solar siting or the GPS method when possible (see Sections 2.5.2.3 and 2.5.2.4). The measured orientation of the antennas should be compared with the system software settings of the system. The antenna alignment should be maintained within $\pm 2^\circ$, which is consistent with wind direction vane alignment criteria.
- ▶ For multi-axis antennas, the inclination angle, or zenith angle from the vertical, should be verified against the software settings and the manufacturer’s recommendations. The measured zenith angle should be within $\pm 2^\circ$ of the software setting in the data system.
- ▶ For phased-array antennas, and for the vertical antenna in a multi-axis system, the level of the antenna should be within $\pm 2^\circ$ of the vertical.
- ▶ For multi-axis Sodar systems, a separate distinct pulse, or pulse train in the case of frequency-coded pulse systems, should be heard from each of the antennas. In a frequency-coded pulse system there may be a sound pattern that can be verified. The instrument manual should be checked to see if there is such a pattern.
- ▶ The controller and data collection devices should be checked to ensure that the instruments are operating in the proper mode and that the data being collected are those specified by the SOPs.
- ▶ Station logbooks, checklists, and calibration forms should be reviewed for completeness and content to ensure the entries are commensurate with the expectations in the procedures for the site.

- ▶ The site operator should be interviewed to determine his/her knowledge of system operation, maintenance, and proficiency in the performance of QC checks.
- ▶ The antenna enclosures should be inspected for structural integrity that may cause failures as well as for any signs of debris or animal or insect nests that may cause drainage problems in the event of rain or snow.
- ▶ Preventive maintenance procedures should be reviewed for adequacy and implementation.
- ▶ The time clocks on the data acquisition systems should be checked and compared to a standard of 2 minutes.
- ▶ The data processing procedures and the methods for processing the data from sub-hourly to hourly intervals should be reviewed for appropriateness.
- ▶ Data collected over a several-day period should be reviewed for reasonableness and consistency. The review should include vertical consistency within given profiles and temporal consistency from period to period. For radar wind profilers and Sodars, special attention should be given to the possibility of ground clutter (i.e., fixed echoes) and/or active noise source contamination in the data.

8.6.2 Sodar Performance Audit

A performance audit of a Sodar should use a responding device (see Baxter, 1994, for a description⁵³) and/or a data intercomparison. A responding device independently assesses the ability of the instrument to correctly interpret test signals that represent known wind speeds. The responding device emits a fixed audio frequency at a known time that is received by the Sodar's antenna. When the Sodar receives the signal, it interprets the audio frequency as a Doppler shift. If the Sodar is operating properly, it should correspond to a known velocity. The timing of the signal is used to verify that altitude is interpreted properly. This type of performance audit tests the complete processing of a known signal through all Sodar system components.

Since a Sodar works on the principle of measuring winds on a component basis, the audit data should be evaluated on that basis. Audit results for a properly operating Sodar should be within 0.2 m/s on a component basis using a responding device. Audits using such a device should be performed over at least three averaging intervals and simulated over a range of normally observed wind speeds.

The responding checks cannot verify that beam steering is being done properly by a phased array Sodar. Since there are no simple techniques for field verification of the beam angles, it is recommended that a comparison of the Sodar data with an independent measurement technique be made to assess the reasonableness of the measurements. This will help identify any major problems with the system such as improper acoustic beam steering, antenna alignment, etc. The comparison can be made using collocated adjacent tower data, radiosondes, a tethered balloon, an anemometer kite system, another remote sensor, or a balloon sounding system. It is recommended that such comparisons include a minimum of five data collection intervals when at least two different wind regimes are evident. Section 8.2 provides the procedures for intercomparing data from two different sensors, and Table 8-3 provides comparison criteria.

8.6.3 Radar Wind Profiler Performance Audit

At present, performance audits of radar wind profilers rely on comparisons to collocated or nearby upper-air measurements to evaluate the performance of the system. Various types of comparison instruments can be used: tall towers, Sodars, radiosondes, and other balloon techniques. A tethered balloon can be used, but care should be taken to ensure that it does not interfere with the radar data. Since it is important to have confidence in the reference instrument, it must also have an independent verification of operation. Section 8.2 provides the procedures for intercomparing data from two different sensors.

Audits using a Sodar (either multi-axis or phased-array) should be performed with the Sodar collocated with the profiler system and configured to collect data using similar temporal and spatial averaging periods. The Sodar should be operated for at least 24 hours with the height coverage overlapping the radar wind profiler data for at least four sampling altitudes. The philosophy behind this approach is that the operational principles of the profiler are consistent throughout its vertical range, so that “good” comparisons at the lowest range gates should indicate acceptable performance at higher altitudes as well. In comparing the data sets, it is important to process the Sodar data in the same manner as the profiler data. This means vertical velocity corrections may be needed to the Sodar data as well as vertical volume averaging of the Sodar range gates to make them comparable with the profiler range gates. In addition, the averaging periods of the two systems need to be consistent. When a RASS is in operation, it is likely the Sodar data will be contaminated and should not be included in the average.

A quick review of the Sodar and radar data should be made prior to dismantling the Sodar to ensure adequate coverage of overlapping data. If needed, additional periods of data collection (up to 72 hours or more) may be required to attain confidence that the systems are both operating correctly and that the collected data are adequate to characterize the performance of the radar. The key is to have adequate data to obtain confidence in the measurement comparison.

Performance audits using a radiosonde system should include at least three soundings collected over the diurnal cycle so that a variety of stability conditions are encountered. A radiosonde sounding provides vertical coverage over the full operating range of the radar. Its drawbacks include the lack of spatial consistency as the balloon travels away from the radar site, as well as the instantaneous profile from the balloon, as opposed to the time-integrated averaged data produced by the radar.

When comparing data from two different upper-air remote sensors, it is important to average the data from the audit sensor so that the time steps and range gates are similar. In addition, it is important to process the wind data along each antenna radial to provide information that can more easily diagnose problems that may be caused by phasing or antenna related problems. The systematic differences at all levels should be about ± 1 m/s for the u and v components calculated along the antenna beams— ± 1 m/s for wind speed and $\pm 10^\circ$ for wind direction. Comparabilities should be better than ± 2 m/s for speed and $\pm 30^\circ$ for direction, as discussed in Table 8-3.

To conduct performance audits using an adjacent tall tower, at least one measurement level on the tower must fall within the profiler’s sample volume. Data should be compared for at least 24 hours, after which the statistics should be comparable with the criteria in Table 8-3.

If differences exceed the tolerances indicated above or the data quality objectives of the program, then it is important to try to understand why the differences occurred before assuming there is a problem with the Sodar or profiler. The reasons may lie in unusual meteorological conditions and/or be due to different sampling techniques and data reduction protocols used by the reference instrument. If differences exist, both data sets should be examined carefully to determine the cause of the differences. If a problem is

identified, users should determine if it is an isolated problem only affecting a few data points or a systematic problem affecting all of the data. Additional intercomparisons may be needed to resolve the differences.

8.6.4 RASS Performance Audit

As with the radar wind profiler, performance audits of RASS rely on a comparison to a reference instrument. The recommended method is to use a balloon sounding system to measure the variables needed to calculate T_v (i.e., pressure, temperature, and relative humidity). At least three soundings should be made for an audit during different times of the day to evaluate the performance of the system under different stability conditions. Soundings should be launched while the RASS is operating to avoid potential differences between the measurements caused by meteorological variability. Data collected from the radiosonde should be volume averaged into intervals consistent with the RASS averaging volumes, and values compared on a level-by-level and overall basis. When both the RASS and radiosonde systems are operating properly, the systematic difference should be within ± 1 degrees C and with an operational comparability of 1.5 degrees C, as listed in Table 8-3.

9. Data Acquisition Systems and Meteorology

9.1 Introduction

This section provides information about Data Acquisition Systems (DAS), a term signifying systems that collect, store, summarize, report, print, calculate, or transfer data. The transfer is usually made from an analog or digital format to a digital medium. However, with “new generation” systems, DAS and most meteorological sensor manufacturers offer a digital option that allows the digital signal to go directly from the sensor to the DAS. EPA recommends that SLT agencies consider migrating from analog-to-digital (A/D) to digital-to-digital (D/D) data transfer. Reasons will be discussed in this section.

DAS have been available to air quality professionals since the early 1980s. Previous to DAS, meteorological data could only be recorded on strip chart recorders, which had some drawbacks:

- ▶ Manual reduction of data from the strip charts.
- ▶ Ink “bleed” that obscured accurate readings.
- ▶ Ink delivery systems that ran dry, hence, loss of data.
- ▶ Large amounts of paper needing storage.
- ▶ If ink did not dry completely, charts adhering to each other, thus obscuring the readings.

Simpler analog systems utilize the electrical output from a transducer to directly drive the varying pen position on a strip chart. For some variables, such as wind run (total passage of wind) and precipitation, the transducer may produce a binary voltage (either “on” or “off”) which is translated into an event mark on the strip chart. Most SLT agencies either have migrated away from strip chart recorders or only use these devices in backup operations.

The first DAS were single- and multi-channel systems that collected data on magnetic media. These media were usually hand-transferred to a central location or laboratory for downloading to a central computer. The advent of digital data transfer from the stations to a central location diminished the need to hand-transfer meteorological data. In addition, since DAS had rapid scan rate capability (i.e., once per second or less), data collected could also be converted quickly to vector or sigma data. This allowed end users (i.e., modelers) to input additional data into complex models to understand transport of pollution downwind of sources.

9.2 DAS Data Acquisition in Analog Layout – Signal Conditioning

Many analog systems and virtually all digital systems require a signal conditioner to translate the transducer output into a form that is suitable for the remainder of the DAS. This translation may include amplifying the signal, buffering the signal (which in effect isolates the transducer from the DAS), or converting a current (amperage) signal into a voltage signal.

9.3 Instrument Connectivity

Technological advances in DAS and meteorological sensors provide analog or digital interface of sensor signals to the DAS. The A/D and D/D options are discussed in the following sections.

9.3.1 Analog-to-Digital Conversion

A key component of any digital DAS is the A/D converter. The A/D converter translates the analog electrical signal into a binary form that is suitable for subsequent processing by digital equipment. In most digital DAS, a single A/D converter is used for several data channels through the use of a multiplexer. The rate at which the multiplexer channel switches are opened and closed determines the sampling rates for the channels. All channels need not be sampled at the same frequency.

Figure 9.1 shows a DAS rear panel with sensor analog signal cable attached to an 8-channel differential input terminal strip. The meteorological sensor has a DC voltage potential that is proportional to the specific measurement being recorded. Most meteorological instruments' outputs are in the 0-1 or 0-5 VDC range. The A/D converter basically performs the following functions during the analog conversion process:

- ▶ The voltage is measured by the multiplexer which allows voltages from many instruments to be read at the same time.
- ▶ The multiplexer sends a signal to the A/D converter which changes the analog voltage to a low amperage digital signal.
- ▶ The A/D converter send signals to the central processing unit (CPU) that directs the digital electronic signals to a display or to the random access memory (RAM) which stores the short-term data until the end of a pre-defined time period.
- ▶ The CPU then transfers the data from the RAM to the storage medium which can be magnetic tape, computer hard-drive, or computer diskette.
- ▶ The computer storage medium can be accessed remotely or at the monitoring location.

Data transfer can occur via modem to a central computer storage area or printed out as hard copy. In some instances, data can be transferred from one storage medium to another storage medium (e.g., hard drive to a diskette or tape). Due to varying voltages and analog system connections, interferences and voltage "leakage" can occur, which can cause errors. Following is a list of some A/D concerns.

- ▶ In high sensitivity applications, the signal exists at the bottom of the usable voltage range, and the data stream may be affected by noise.
- ▶ The A/D range may be limited to 10 bit (1024 steps) in some cases.
- ▶ A/D calibrations may be required to "match" sensor output to DAS input readings.

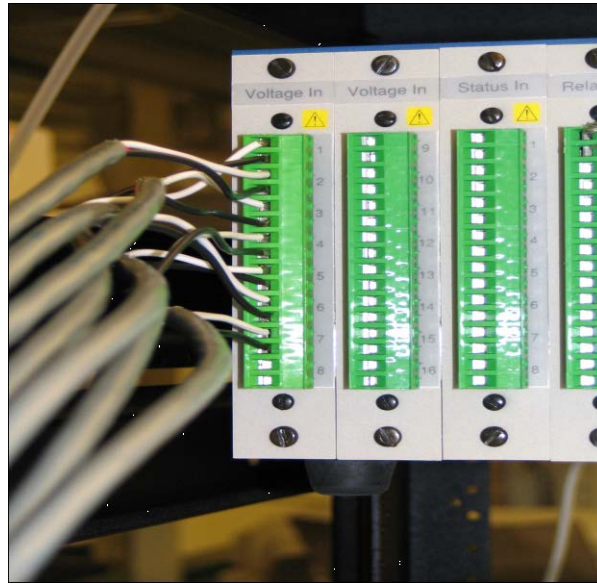

Figure 9.1 DAS Rear Panel with 8-Channel Differential Analog Terminal Strip

9.3.2 Digital Connectivity

D/D transfer has several advantages:

- ▶ Multiple data types can be transferred with a single connection.
- ▶ Single cable interface reduces clutter at the DAS rear panel.
- ▶ Ground loops are eliminated to improve data integrity.
- ▶ A/D calibrations are not required.
- ▶ There is additional flexibility in tracking signal over-range conditions.
- ▶ Digital systems are sensitive to changes in sensor firmware and output formats.

Figure 9.2 shows DAS rear panel with RS-232 signal interface.

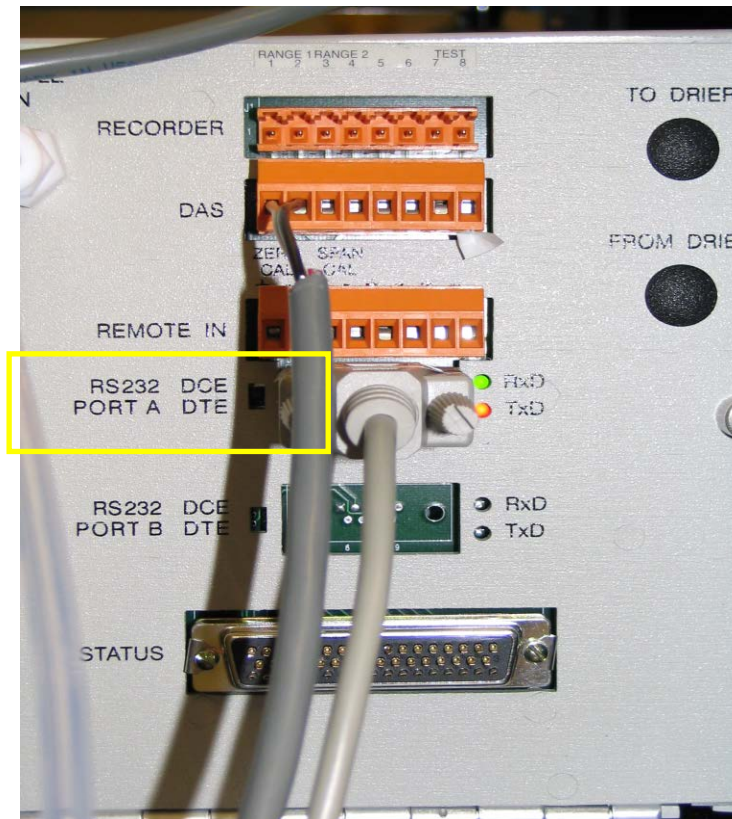

Figure 9.2 DAS Rear Panel with RS-232 Signal Interface

9.4 Data Communication

Depending on the type of system, there may be several data communication links. Typically the output signals from the transducers are transmitted to the on-site recording devices directly via hardwire cables. For some applications involving remote locations, the data transmission may be accomplished via a microwave telemetry system or telephone lines with a dial-up or dedicated line modem system. Also, wireless internet connection is available for real-time communication with the site DAS.

9.5 Sampling Rates

The recommended sampling rate for a digital DAS depends on the end use of the data. Substantial evidence and experience suggest that 360 data values evenly spaced during the sampling interval will provide estimates of the standard deviation to within 5 percent or 10 percent.² Estimates of the mean should be based on at least 60 samples to obtain a similar level of accuracy. Sometimes fewer samples will perform as well, but no general guide can be given for identifying these cases before sampling; in some cases, more frequent sampling may be required.

If single-pass processing is used to compute the mean scalar wind direction, the output from the wind-direction sensor (wind vane) should be sampled at least once per second to ensure that consecutive values do not differ by more than 180 degrees. The sampling rate for multi-point analog recorders should be at least once per minute. Chart speeds should be selected to permit adequate resolution of the data to achieve

the system accuracies recommended in Section 0.2.2. The recommended sampling rates are minimum values; the accuracy of the data will generally be improved by increasing the sampling rate.

9.6 Meteorological Data Generated by DAS

A number of parameters are generated by state-of-the-science DAS:

- ▶ Wind speed (WSV or vector), wind direction (WDV or vector)
- ▶ Wind direction standard deviation (sigma theta)
- ▶ Standard deviation of the vertical wind speed (sigma W)
- ▶ Standard deviation of the vertical wind direction (sigma phi)
- ▶ Wind speed and direction averages (WSA and WDA)

Specific equations are used in the calculation of these variables. These equations are defined in the following subsections. Generally, the data will be calculated on a 1-second scan rate, but reported as an hourly value averaged from the 3,600 1-second values.

9.6.1 WSV and WDV Calculations⁶⁰

The hourly calculations for WSV and WDV provide a vector average of all the instantaneous samples of wind direction (WD_i) and instantaneous wind speed (WS_i) sampled each hour. The following equations are used.

$$U = \frac{\sum_{i=1}^N [WS_i * \sin(WD_i)]}{N} \quad (9-1)$$

$$V = \frac{\sum_{i=1}^N [WS_i * \cos(WD_i)]}{N} \quad (9-2)$$

$$WDV = \arctan\left(\frac{U}{V}\right) + FLOW \quad (9-3)$$

Where:

$$FLOW = \begin{bmatrix} +180^\circ \rightarrow \arctan\left(\frac{U}{V}\right) \rightarrow < 180^\circ \\ -180^\circ \rightarrow \arctan\left(\frac{U}{V}\right) \rightarrow > 180^\circ \end{bmatrix}$$

$$WSV = (U^2 + V^2)^{\frac{1}{2}} \quad (9-4)$$

Where

- U = the east-west component
- V = north-south component of the wind

N = the number of instantaneous samples

The signs (positive or negative) of U and V are used to place WDV in the proper sector. Equation 9-3 assumes that the angle returned by the ArcTan function is in degrees.

The unit vector approach to computing mean wind direction is similar to the vector mean described above except that the east-west and north-south components are not weighted by the wind speed. Using the unit vector approach, equations 9-5 and 9-6 become

$$U = -\frac{1}{N} \sum \sin(WD) \quad (9-5)$$

$$V = -\frac{1}{N} \sum \cos(WD) \quad (9-6)$$

The unit vector mean wind direction is

$$WDV = \arctan\left(\frac{U}{V}\right) + FLOW \quad (9-7)$$

where

$$FLOW = \begin{cases} +180^\circ \rightarrow \arctan\left(\frac{U}{V}\right) \rightarrow < 180^\circ \\ -180^\circ \rightarrow \arctan\left(\frac{U}{V}\right) \rightarrow > 180^\circ \end{cases}$$

In general, the unit vector result will be comparable to the scalar average wind direction and may be used to model plume transport.

9.6.2 Standard Deviation of Wind Direction (sigma theta)

Sigma theta (σ_θ) is collected for the sole purpose of estimating lower atmospheric stability. The suggested stability calculation method is detailed in EPA, 2002. Sigma theta can be calculated from the instantaneous wind direction values using the basic definition of standard deviation.

$$\sigma_\theta = \left[\frac{\sum_{i=1}^N (WD_i - WDA)^{1/2}}{N - 1} \right] \quad (9-8)$$

It has been suggested that the upper limit of sigma theta should be limited to 103.9 degrees. Sigma theta calculated over 60 minutes is influenced by the changing wind direction during the hour. For this reason, it is recommended that four 15-minute sigma theta calculations be combined to provide a "1-hr" value for the purpose of selecting a Pasquill-Gifford stability class. The following method describes how the hourly values should be calculated.

$$\sigma_{A(1-hr)} = \left[\frac{\sigma_{A(15)}^2 + \sigma_{A(30)}^2 + \sigma_{A(45)}^2 + \sigma_{A(60)}^2}{4} \right]^{1/2} \quad (9-9)$$

Where each $\sigma_{A(15X)}^2$ equation is a 15-minute deviation of the wind direction.
 $\sigma_{A(15)}^2$ for example is calculated between 00 and 15 minutes.

Several methods for calculating the standard deviation of the wind direction were evaluated by Turner (REF); a method developed by Yamartino (REF) was found to provide excellent results for most cases. The Yamartino method is shown in equation 9-10:

$$\sigma_A = \sigma_\theta = \arcsin(\varepsilon) [1 + 0.1547\varepsilon^3] \quad (9-10)$$

where

$$\varepsilon = \left[1 - \left(\overline{\sin(WD)}^2 + \overline{\cos(WD)}^2 \right) \right]^{1/2}$$

9.6.3 Standard Deviation of the Vertical Wind Speed (sigma W)

The standard deviation of the vertical component of the wind speed is

$$\sigma_w = \left[\frac{1}{N} \left\{ \sum_1^N w_i^2 - \frac{1}{N} \left(\sum_1^N w_i \right)^2 \right\} \right]^{1/2} \quad (9-11)$$

9.6.4 Standard Deviation of the Vertical Wind Direction (sigma phi)

Sigma phi (σ_ϕ) is another method for estimating lower atmospheric stability. The suggested stability calculation method using sigma phi is detailed in Meteorological Monitoring Guidance for Regulatory Modeling Applications.⁴

$$\sigma_\theta = \frac{\sigma_\omega}{WSA} \quad (9-12)$$

Equation 9.12 yields sigma phi (σ_ϕ) in units of radians and must be converted to degrees:

Sigma phi (degrees) = Sigma phi (radians) x 57.2958

9.7 Identification of Data Acquisition Calculation Issues

If a problem with the monitoring system is suspected, an examination of long-term data trends can help validate the data or troubleshoot the system. Problems with the sensor, signal conditioner, and data logger may be detected using the following analyses:

- ▶ Time series plots comparing parameters at a variety of stations (see Figure 9.3).
- ▶ Scatter plots of data, such as Figure 9.4. This type of plot can be used to compare data offsets.
- ▶ Wind rose plots. A significant change in wind rose plots may indicate a problem with the monitoring system. Minor variations in annual wind roses are expected due to inter-annual meteorological variation. For example, a misalignment of the wind direction sensor may be detected using this analysis.
- ▶ Examination of the database to determine minimum and maximum values. For, example, long-term wind direction minimum and maximum values are expected to be close to 0 and 360 for most stations.

Figure 9.3 is a comparison of trends at two stations near each other. Ratios between parameters are typically expected to remain consistent over the long term. A significant change in the ratio between parameters or a change in the inter-annual pattern may indicate a problem with a monitoring system. For example, a significant change is indicated the middle of the Figure 9.3 time series plot. When reviewing these charts, minor inter-annual variability in parameters should also be expected.

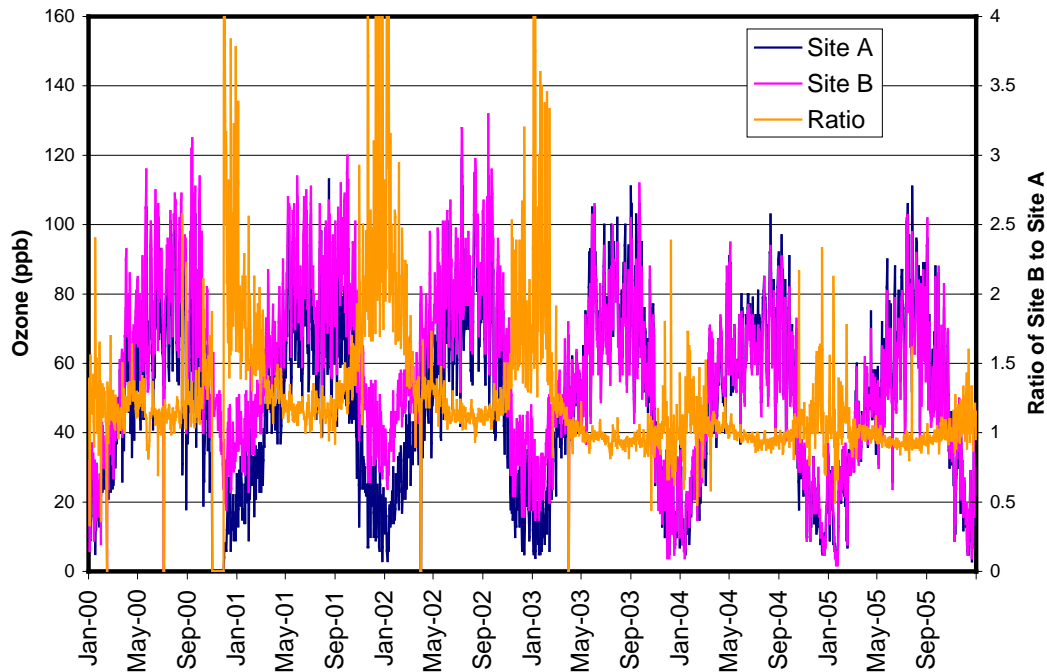

Figure 9.3 A Comparison of Trends at Two Nearby Stations

Figure 9.4 is a comparison of hourly scalar and vector wind direction data for two time periods at a monitoring station. This type of plot may illuminate characteristics of the wind direction calculation. The characteristic of the 2000-2002 time period is very different from the 2004-2006 time period, indicating that a significant change occurred in the vector calculation. The wind direction vector for 2004-2006 does not display samples in the range 0 to 10 degrees, which also indicates a potential problem with the vector calculation. In addition, few observations were reported between 340 degrees and 20 degrees, which also may be an indicator of potential problem with the vector calculation.

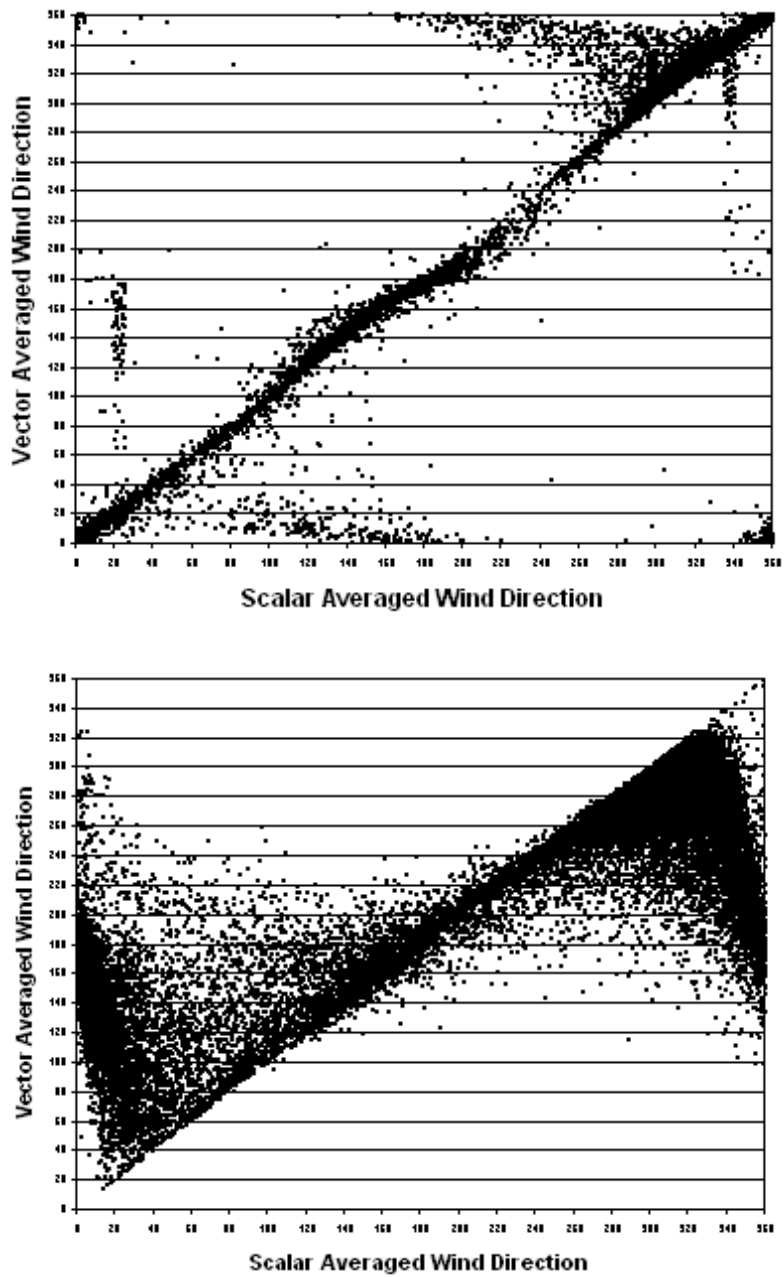

Figure 9.4 A Comparison of Scalar and Vector Wind Direction

10. Meteorological Data Validation and Verification

Data review, verification, and validation are techniques used to accept, reject, or qualify data in an objective and consistent manner. Verification can be defined as confirmation by examination and objective evidence that specified recommendations have been fulfilled. Validation can be defined as confirmation by examination and objective evidence that the particular recommendations for a specific intended use are fulfilled. It is important to describe the criteria for deciding the degree to which each data item has met its quality specifications as described in an organization's QAPP. This section describes the techniques used to make these assessments with a focus on meteorological parameters.

In general, these assessment activities are performed by persons implementing the environmental data operations as well as by personnel "independent" of the operation, such as the organization's QA personnel, and at some specified frequency. The procedures, designated personnel, and frequency of assessment should be included in an organization's QAPP. These activities should occur prior to submitting data to the final repository in EPA's Air Quality System (AQS) and before they are utilized in models or forecasts. The following areas of discussion should be considered during verification or validation processes.

10.1 General Approach

How closely a measurement represents the actual environment at a given time and location is a complex issue that must be considered during development of the sampling design. Each sample should be checked for conformity to the specifications, including type and location (spatial and temporal). By noting the deviations in sufficient detail, subsequent modelers and other data users will be able to determine the data's usability under scenarios different from those included in project planning.

Ambient air pollution data and meteorological data are linked. Pollution either forms chemically in the atmosphere or it is the result of a process. Photochemical pollutants, such as ozone and sulfates, are generally produced over a period of time. Ozone forms by the interaction of VOCs and NO_x under the right meteorological conditions when low wind speeds, variable wind directions, and relatively high temperatures are present.

Other pollutants are generated by point and area sources. Winds, a meteorological variable, can transport pollutants great distances from their sources to affect populated areas. There are several examples of the interaction of ambient air pollution and meteorology in Section 10.4 of this document. **Therefore, if possible, meteorological data should be validated and verified at the same time as pollution data, not separately.**

Figure 10.1 is a simplified illustration of a typical validation and verification process. Three distinct columns are illustrated in this schematic. The left column shows the "levels of data". These levels of data are described in detail later in Section 10.1.1. The central column is a visualization of the data flow from meteorological sensors to the AQS. The right column illustrates the type of verification or validation that usually occurs during the process. The numbers in parentheses reference the section numbers in this document.

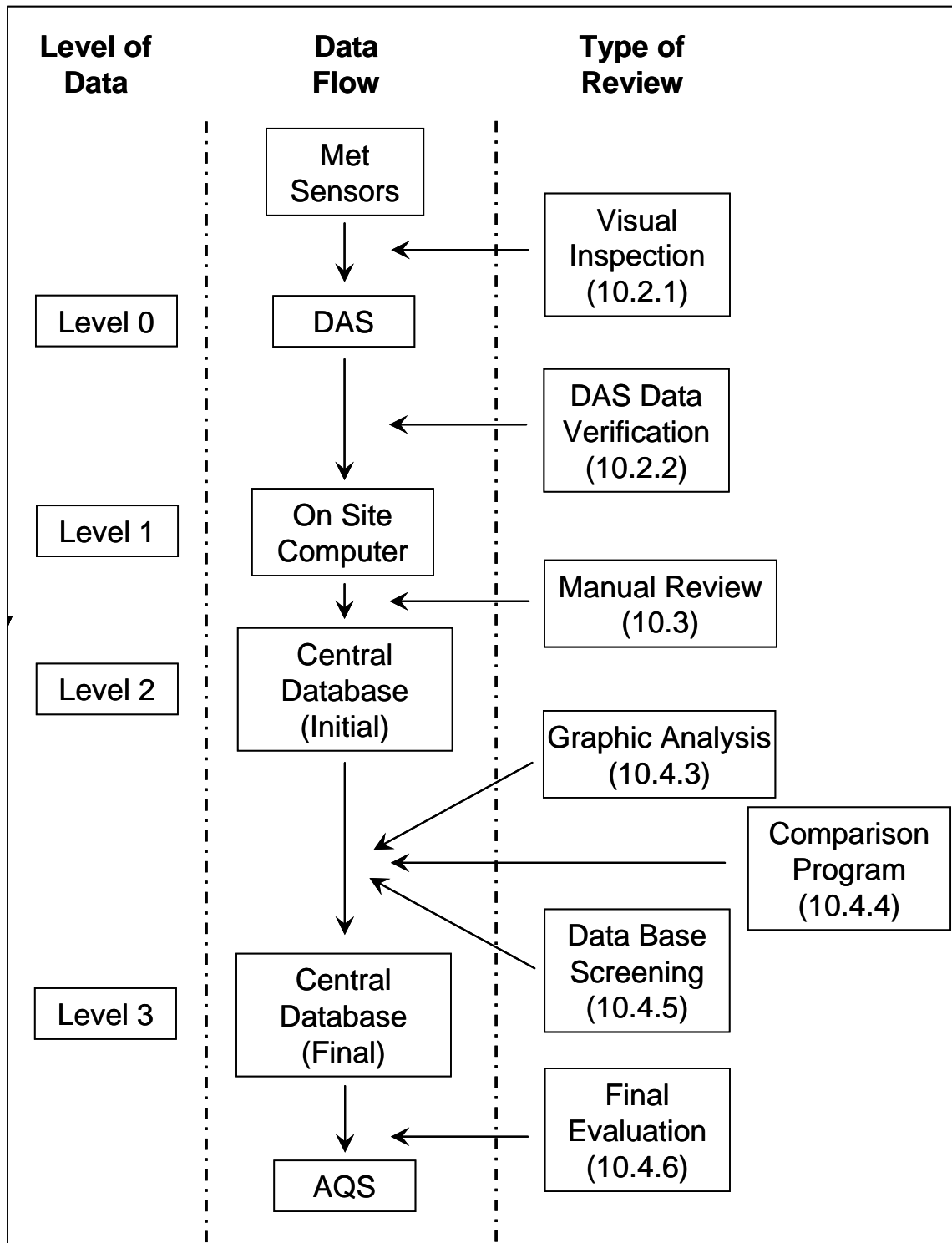

Figure 10.1 Generalized Data Validation and Verification Process Flow

10.1.1 Levels of Validation

Generally, there are four “levels” of air quality and meteorological data validation. These levels are defined by Mueller and Watson⁶¹ and Watson et al.⁶² When a data set has undergone a level of review, it passes on to the next level. The process is used to determine the validity of the data.

- ▶ Level 0 validated data are essentially raw data obtained directly from the DAS in the field. Level 0 data have been reduced and possibly reformatted, but are unedited and un-reviewed. These data have not been adjusted for known biases or problems that may have been identified during preventive maintenance checks or audits. These data may be used to monitor instrument operations on a frequent basis but should not be used for regulatory purposes.
- ▶ Level 1 data validation involves quantitative and qualitative reviews for accuracy, completeness, and internal consistency. Quantitative checks are performed by DAS software screening programs (see Section 10.2.2), and qualitative checks are performed by meteorologists or field staff who manually review the data for outliers and problems. Quality control flags are assigned, as necessary, to indicate the data quality. Data are only considered validated at Level 1 after final audit reports have been issued and any adjustments, changes, or modifications to the data have been made.
- ▶ Level 2 data validation involves comparisons with independent data sets. This function includes, for example, making comparisons to other meteorological or ambient pollution data or upper-air measurement systems.
- ▶ Level 3 data validation involves a more detailed analysis and final screening of the data. The purpose of the final step is to verify that there are no inconsistencies among the related data (such as problems with scalar and vector data or problems consistent with temperature and its related relative humidity). Graphics programs may be run to examine the overall consistency among related data (i.e., checking diurnal patterns against other parameters or reviewing strip charts for final analysis).

10.2 Data Verification Methods

Data verification is defined as the confirmation by examination and objective evidence that specified recommendations have been fulfilled. These recommendations should be included in the organization’s QAPP and in SOPs. The data verification process involves two basic steps: visual inspection and analysis and verification performed by DAS. Both techniques are needed to verify meteorological data. Each is described in the following sections.

10.2.1 Visual Data Verification

Some meteorological data can be verified visually. For example, under windy conditions, the cup anemometer and vane system at a monitoring station should move. Rainfall can be measured. Other visual verification techniques, which include inspections, can be technical systems audits (internal or external) or frequent inspections by field operators. Several questions might be asked during a visual verification process:

1. Is the equipment performing correctly? Individual checks such as electronic checks, zero checks, and other assessments must have been acceptably performed and documented.
2. Did the equipment and its performance pass an initial visual inspection? A station operator should look at the meteorological equipment during a site visit. If the wind speed cups are spinning and the vane is responding to wind, does the motion correlate to a reasonable value? Does the measured temperature appear to be “fairly accurate”? If the weather is warm enough to work without a coat, is temperature above 10 degrees C. Is it clear or overcast? If it is clear, the assumption might be that solar radiation would be relatively high. Many environmental samples can be flagged (qualified) during the periodic visual inspection.
3. Part of the verification process is a review of the meteorological data and the current weather over a period of time. It is important that the station operator review the data collected from the last visit. A quick visual inspection may reveal some anomalies that do not match other parameters. For example, if an operator sees a high humidity value in the DAS, does it have a corresponding relatively high temperature value. If the interactions of the meteorological parameters are understood, general conclusions can be drawn. A quick look at the tabular data may illustrate anomalies that can be studied during the validation process.

Figure 10.2 is an illustration of a local air pollution agency’s monitoring station meteorological sensor checklist. This example lists items that must be checked by the station operator every time that he/she visits the site. A discussion of the items on the checklist follows:

- ▶ **Tower Check.** The tower check is a visual inspection of each sensor on the meteorological tower. Each time an operator visits, he/she should look every external instrument. Cups, vanes, temperature shields, and NEMA 4 enclosures should be checked for damage or possible blockage by animals or debris.
- ▶ **Wind Check.** The wind speed and direction are estimated by the operator and marked on the form. Once this estimation is performed, the operator notes the reading from the DAS. Do the estimates and the readings match reasonably? The values recorded by the operator should be checked against the strip chart recorder. Do they match?
- ▶ **Temperature Check.** A sling, motorized psychrometer should be operated, and the temperature and relative humidity should be checked against the DAS reading.
- ▶ **Sky Check.** Recording sky conditions helps to determine whether the solar and UV radiation values are relatively accurate. Other useful checks are to visually check for passing clouds. If clouds obscure the sunlight, UV and solar radiation values should drop quickly. If the operator arrives early in the morning, solar radiation values will increase slowly over an hour’s time, verifying that the sensor is working.
- ▶ **Rainfall Check.** The tipping bucket rain gage should be checked to determine if the funnel opening is free of debris; if not, the funnel should be cleaned. The relay switch on the gauge should be checked by manually tipping the bucket apparatus 10 times; that the DAS recorded the equivalent of 10 tips should be confirmed. The rainfall channel on the DAS must be taken “off-line” prior to performing the manual check to avoid recording erroneous rainfall data and returned to “on-line” status after completion of the manual check.
- ▶ **Barometric Pressure.** The barometric pressure reading should be checked for reasonableness with the local NWS or a reliable second barometer. The hourly data from the DAS should reflect a rising or falling barometer based the advances of high or low pressure frontal passages

Weekly Quality Control Check Sheet Meteorological Instruments															
Site _____				Month/Year _____											
Site Number _____				Technician _____											
Date: <table border="1" style="display: inline-table; border-collapse: collapse;"> <tr> <td style="width: 20px; height: 20px;"></td> <td style="width: 20px; height: 20px;"></td> <td style="width: 20px; height: 20px;"></td> <td style="width: 20px; height: 20px;"></td> <td style="width: 20px; height: 20px;"></td> <td style="width: 20px; height: 20px;"></td> <td style="width: 20px; height: 20px;"></td> <td style="width: 20px; height: 20px;"></td> </tr> </table>															
Tower Check:	Crossarm aligned with north?														
	WS cups okay?														
	WD vane okay?														
	VWS propeller okay?														
	T & RH shield okay?														
	Solar radiation okay?														
	UV radiation okay?														
Wind Check:	WS estimate (1)														
	WS DAS (m/s)	mps	mps	mps	mps	mps	mps								
	WS Chart %	%	%	%	%	%	%								
	WD estimate (2) (deg)	deg	deg	deg	deg	deg	deg								
	WD DAS (deg)	deg	deg	deg	deg	deg	deg								
	WD Chart %	%	%	%	%	%	%								
Temperature Check:	T dry (deg C)	degC	degC	degC	degC	degC	degC								
	T wet (deg C)	degC	degC	degC	degC	degC	degC								
	RH % calculation (3)	%	%	%	%	%	%								
	Temp. DAS (deg C)	degC	degC	degC	degC	degC	degC								
	RH % DAS	%	%	%	%	%	%								
Sky Check:	Sky condition (4)														
	SRD DAS (mly/10)														
	UV DAS (mly)														
<p>All comments must be noted in the station log.</p> <div style="display: flex; justify-content: space-between;"> <div style="width: 45%;"> <p>(1) WS estimate C = calm (0-1 mps) L = light (1-3 mps) M = moderate (4-6 mps) S = strong (> 6 mps)</p> <p>(2) WD estimate N, NE, E, SE S, SW, W, NW</p> </div> <div style="width: 45%;"> <p>(3) Calculated RH From graph on reverse side</p> <p>(4) Sky condition (choose 1 or more)</p> <table style="width: 100%; border: none;"> <tr> <td>CLR (clear)</td> <td>F (fog)</td> </tr> <tr> <td>PC (partly cloudy)</td> <td>S (smog)</td> </tr> <tr> <td>CLDY (cloudy)</td> <td>H (haze)</td> </tr> <tr> <td>OVC (overcast)</td> <td>R (rain)</td> </tr> </table> </div> </div> <p>Reviewed by _____ Date _____</p>								CLR (clear)	F (fog)	PC (partly cloudy)	S (smog)	CLDY (cloudy)	H (haze)	OVC (overcast)	R (rain)
CLR (clear)	F (fog)														
PC (partly cloudy)	S (smog)														
CLDY (cloudy)	H (haze)														
OVC (overcast)	R (rain)														

Figure 10.2 Example of Meteorological Sensor Visual Check List

10.2.2 Data Verification Performed by DAS

In the late 1980s, DAS became available to the air pollution monitoring community. These early systems could collect voltage data (analog information) and convert those data to a digital format. Later DAS versions had the ability to take instant readings from wind instruments and calculate the vector and sigma (i.e., the standard deviation) of wind data. Some DAS have been programmed with the ability to sense out of the ordinary changes in the signal that humans would not be able to detect. These types of verification techniques can be extremely useful because the program can “sense” a change in operating conditions when or even before equipment fails. It is strongly recommended that these DAS verification checks be a part of the data acquisition routine and examined by station operators and data validation staff. Listed below are data verification questions that should be considered to allow the DAS to perform automated verification checks.

- ▶ Did the value exceed the DAS maximum reading limit?
- ▶ Did the value exceed the DAS minimum reading limit?
- ▶ Did the value exceed the maximum rate of change?
- ▶ Does the data have high alarm limit?
- ▶ Does the data have a low alarm limit?
- ▶ Does the data have a floor limit?
- ▶ Does the data need to have a percentage of valid readings to be considered valid?
- ▶ Is there a ceiling limit to the data?
- ▶ Does the data need to be interpolated? If so, is it linear?
- ▶ Does the system have a minimum detectable limit?

Commercially available DAS should have the capability to assign alarm limits for instantaneous and hourly values. This is important because rapid changes may not be flagged for instantaneous values, but could be flagged for an hour value and vice versa. Some of the information that is referenced in the table should be set by annual or even quarterly averages. These values also can be refined with time.

Table 10-1 provides recommended automated screening limits on DAS; assuming the wind speed system operating range is 0–50 m/s, with a starting threshold of 0.2 m/s.

Table 10-1 DAS Screening Techniques

Parameter	Value	Comments
Maximum reading	50 m/s	This is the maximum instantaneous reading possible for your system
Minimum Reading	0.2 m/s	This is the minimum instantaneous reading possible for your system because your threshold is 0.2 m/s
Maximum Rate of Change	10 m/s	Winds generally increase gradually, for a particular site, you would not expect winds to change this quickly
High Alarm Limit	40 m/s	This is gale force winds. You would expect damage to sensor or site.
Low Alarm Limit	0.2 m/s	Same as starting threshold
Floor Limit	0.5 m/s	This value is lowest average that you would expect for one hour
Percent Valid Readings	75%	Most data should be valid 75% of the time
Ceiling Limit	30 m/s	This value is highest average that you would expect for one hour
Linearity	1.00+/- 1%	You would expect your sensor to be within 1% accuracy.
Minimum Detectable Limit	0.2 m/s	This is the same as the starting threshold.

10.3 Manual Review Methods

Figure 10.1 shows four types of validation procedures: manual review, graphic analysis, comparison, and database screening. Both manual and computer-oriented systems require individual reviews of all data tabulations. This initial step should be performed by the station operator and later by data validation staff. It is recommended that the data be printed out at the monitoring station and reviewed by the site operators every time they visit the station or at the end of the month. New DAS allow station operators to print the data in a tabular format. These tables can also provide summary data, i.e., highest, lowest and average values. The purpose of manual inspection is to spot unusually high (or low) values (outliers) that might indicate a gross error in the data collection.

Manual review of data tabulations also allows detection of uncorrected drift in the zero baseline of a meteorological sensor. Zero drift may be indicated when the daily minimum values tend to deviate (increase or decrease) from the expected minimum value over a period of several days. Usually, winds in the early morning hours (3 a.m. to 4 a.m.) are light and variable, solar radiation is at its lowest values, and temperatures generally drop which may result in zero baseline drift from temperature, solar radiation, and wind speed sensors.

In an automated data processing system, procedures for data validation can be incorporated into the basic software. As noted in Section 10.2.2, the computer can be programmed to scan data for extreme values, outliers, or ranges. These checks can be further refined to account for time of day, time of week, and other cyclic conditions. Questionable data values flagged on the data tabulation may or may not indicate possible errors. The station operator should check all the data flagged by the DAS data verification program and investigate whether the data flagged should remain flagged. In some cases, extreme meteorological conditions can occur rapidly, and the data may actually reflect real values. For example, if a thunderstorm moves through an area, winds can be recorded as calm but reach 20-30 m/s within

seconds. This extreme value could be flagged by a DAS verification program. The station operator should note such examples and alert the data validation staff that these data actually reflect conditions.

10.3.1 Calibration Data Review

Calibration of instruments and equipment must be performed periodically as referenced in the MQOs tables in Section 0.2.2 in this document. The associated data should be reviewed by station operators and data validation staff. The following questions should be answered:

- ▶ Were the calibrations performed within an acceptable time prior to generation of data?
- ▶ Were they performed in the proper sequence?
- ▶ Were the proper number of calibration points performed?
- ▶ Were they performed using standards that “bracketed” the range of reported measurement results?
- ▶ Were acceptable linearity checks and other checks made to ensure that the measurement system was stable when the calibration was performed?

10.4 Data Validation Methods

Data validation is a routine process designed to ensure that reported values meet the quality goals of environmental data operations. A progressive, systematic approach to data validation must be used to ensure and assess the quality of data. The purpose of this step in the process is to detect, compare, and perform a final screening on all data values. Any final data that may not represent actual meteorological conditions at the sampling station will be detected at this stage. Effective data validation procedures usually are handled independent of the procedures of initial data verification, that is, by different computer systems and staff. Note in Figure 10.1 that the validation process is performed on the data set at the location of the central database. It is important that data validation staff be independent of station operations personnel. These procedures can be performed automatically; SAS®, Microsoft Excel®, or Visual Basic program languages can be scripted to perform these tests. Several local agencies have employed these techniques quite effectively.

If data assessment results clearly indicate a serious response problem with the sensor, the agency should review all related information to determine whether the meteorological data, as well as any associated assessment data, should be invalidated. For example, if a temperature sensor fails a calibration or audit, the relative humidity data, which are calculated from the ambient temperature data, must be invalidated as well. In addition, in the relationship between wind vector and scalar data, if wind speed average data (or wind direction average data) are considered invalid, then the vector data for both wind speed and direction data must also be invalidated since the vector data use both wind speed average and direction for the calculations.

Some problems that may escape detection during an audit (a wind vane that occasionally sticks) are often easily identified during data validation. Data validation should be performed by a person with appropriate training in meteorology who has a basic understanding of local meteorological conditions and the operating principles of the instruments.

10.4.1 Preparatory Steps

Steps preparatory to data validation should include the daily transfer of raw data (e.g. 1-minute or 1-hour average data files) to a central data processing facility and the transfer of raw data files to create an edited database. The raw data files should be stored separately to insure data integrity. Backup copies of the data should be prepared and maintained on-site and off-site.

10.4.2 Validation Procedures

All necessary supporting material, such as audit reports and site logs, should be available for Level 2 validation. Access to a daily weather archive should be provided for use in relating suspect data to local and regional meteorological conditions. Questionable data, such as data flagged in an audit, manual review, or DAS screening program, should be corrected or invalidated during Level 2 data validation.

10.4.3 Graphic Analysis

Graphing data can be a quick method of visualizing the data relative to other parameters. Graphs can show longer term trends and relationships that are difficult to see when data validation staff are looking at large amounts of tabular data. Figures 10.3 and 10.4 illustrate the relationship between different parameters.

Figure 10.3 illustrates the relationship of relative humidity to ambient temperature. During the time period, there was an inverse relationship between the two parameters. By graphing the data, these trends are clear.

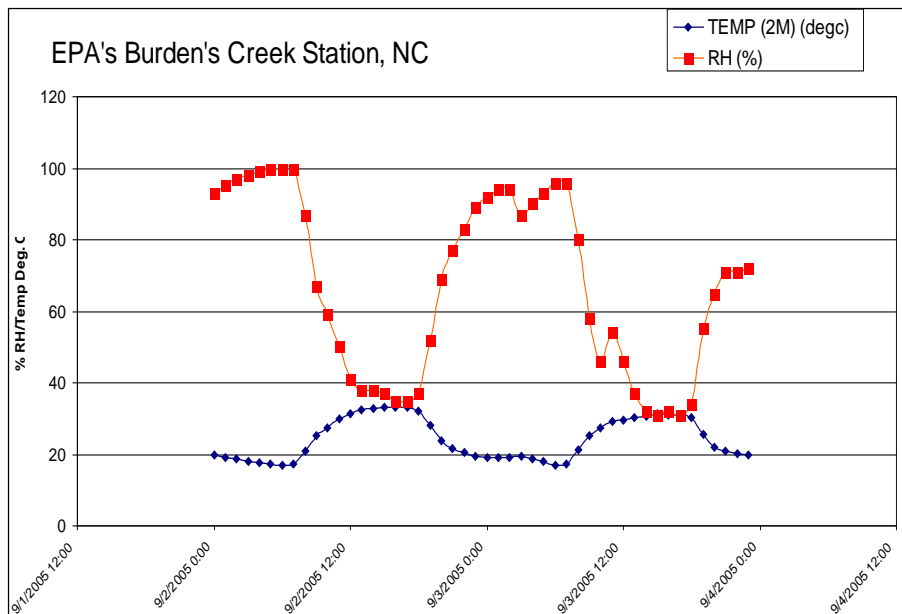

Figure 10.3 Graphic Example of Temperature vs. Relative Humidity

Figure 10.4 illustrates the relationship of ozone to ambient temperature during the period. As the temperature increased with time, ozone also increased. Both sets of data illustrate a diurnal nature.

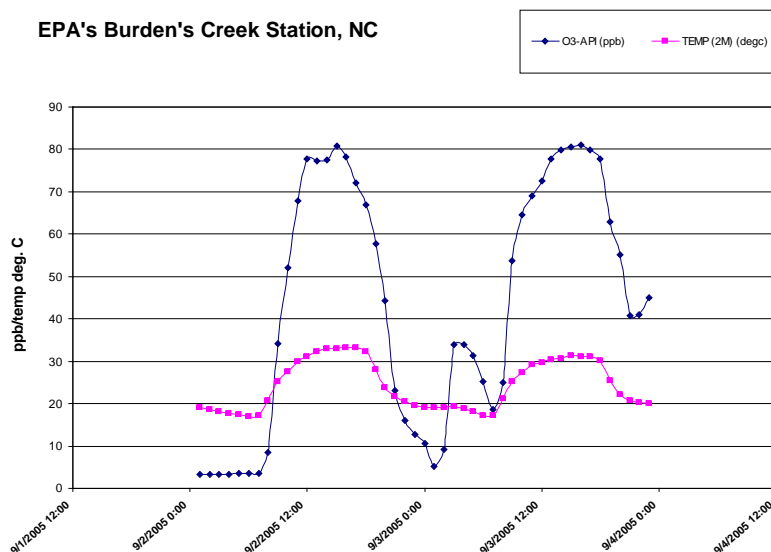

Figure 10.4 Graphic Example of Ozone vs. Temperature

10.4.4 Comparison Program

A useful data validation method is to compare the difference between successive meteorological data values. Logic dictates that rapid changes in values in a 1-hr reporting period would normally not be expected. When the difference between two successive values exceeds a predetermined value, the data in question can be flagged.

Another useful tool is a comparison of data from one monitoring location with a nearby meteorological collection station. Randomly selected values should be manually compared with other available, reliable data (such as data obtained from the nearest NWS observing stations). Several hours out of every five days should be randomly selected. To account for hour-to-hour variability and the spatial displacement of the NWS station, a block of several hours may be more desirable. All data selected should be checked against corresponding measurements at the nearby station. In addition, monthly average values should be compared with climatological norms, as determined by the NWS from records over a 30-year period. If discrepancies are found which can not be explained by the geographic difference in the measurement locations or by regional climatic variations, the data should be flagged as questionable.

10.4.5 Data Screening

Screening procedures generally include comparisons of measured values to upper and lower limits; these limits may be physical, such as an instrument threshold, or may be established based on experience or historical data. Other types of procedures employed in screening include assessments based on the rate of

change of a variable (data that change too rapidly or not at all are flagged as suspect) and assessments based on known physical principles relating two or more variables (e.g., the dew point should never exceed the dry-bulb temperature).

Screening is an iterative process in which range checks and other screening criteria are revised as necessary based on experience. For example, an initial QA pass of a data set using default criteria may result in flagged values which, upon further investigation, are determined to be valid for a particular site. In such cases, one or more follow-up QA passes using revised criteria may be necessary to clearly segregate valid and invalid data.

10.4.5.1 Data Screening Qualifiers

This section lists a number of qualifiers that should be used to determine reasonableness, completeness, accuracy, and representativeness of a meteorological database. The Sample Meteorological Data Screening Checklist, Figure 10.5, should be used to document the data screening results.

- ▶ Was the 75 percent data recovery criterion met?
- ▶ Do wind speed vector and wind direction vector have same data recovery rate? Wind speed and wind direction vectors are interdependent; when one is invalid, the other should also be invalid. Wind speed and wind direction vectors interdependence and other items are easily verified using the database.
- ▶ For meteorological multi-point calibration, was the wind speed slope equal to 1 ± 0.05 m/s? Review any meteorological calibration forms. The slope of the wind speed calibration should be within ± 0.05 of 1.00. The intercept should be within ± 0.3 m/s.
- ▶ Was the wind direction (WD) average within ± 5 degrees? All wind direction values should be within 5 degrees of true north, 90, 180, and 270 degrees, respectively.
- ▶ Was the vertical wind speed (VWS) maximum difference < 0.3 m/s? VWS points should be within 0.3 m/s of true.
- ▶ Was the temperature maximum difference less than $< 1^\circ\text{C}$? Temperature sensor response should be within ± 1.0 degrees C of CTS response. The audit and calibration criteria are essentially the same and represent the accuracy recommendations of temperature data. Temperature data collected with sensors that fail to meet audit and calibration criteria must be corrected or invalidated. Temperature data can be corrected using correction factors derived from the most recent calibration results.
- ▶ Was vector wind speed less than or equal to scalar wind speed? Spot check the monthly summaries of vector wind speed and average wind speed to verify that vector wind speed is always less than or equal to average wind speed. In most cases, the values should be very close to each other. If a discrepancy exists, resolve it by reviewing the 1-minute average data from the electronic strip chart graphs (if available).
- ▶ Are average wind direction and vector wind direction comparable? Spot check the monthly summaries of vector wind direction and average wind direction values. The values should be within 5 to 10 degrees of each other. If a large discrepancy exists, the sigma theta for the period should also be high.
- ▶ Are sigma W and vertical wind speed comparable? A preliminary check should show that low (near zero) sigma W values were accompanied by low vertical wind speed values. The inverse may not be true.

- ▶ Are sigma V and WS*sin(sigma theta) comparable? Check a few of the sigma v values, concentrating on the high values. A more reliable algorithm is:

$$(\text{sigma } v)^2 = \text{WSA}^2 - \text{WSR}^2$$

Estimated and reported values should usually compare to within 10 percent of each other.

- ▶ Are there any hand-reduced sigma or vector data? Hand-reduced sigma and vector data are invalid.
- ▶ Do sigma theta values and wind direction chart scatters coincide? In general, the higher the scatter, the higher the sigma. A more quantitative comparison can be made for any sigma parameter by estimates of the range of the scatter for the hour divided by 4. This calculation should be made occasionally during the review for both sigma theta and sigma W.
- ▶ Is the zero offset for wind speed correct? The chart trace should have a zero offset built in, corresponding to about 0.5 m/s in order to verify chart-to-data comparison accuracy.
- ▶ Are wind speed noise/bearings at threshold speeds? To avoid data bias, wind speed data should only be invalidated if the problem is considered significant enough to invalidate data that is near the threshold. The agency should determine how much data is not valid.
- ▶ Do wind speed vector (WSV) and wind direction vector (WDV) have the same data recovery rates?
- ▶ Are average WD and vector WD comparable?
- ▶ Does wind speed average (WSA) affect wind speed vector (WSV), wind direction vector (WDV), sigma phi, and sigma v?
- ▶ Does WDA affect WDV, WSV, sigma theta, and sigma y?

10.4.6 Final Evaluation

Data flagged by the DAS screening and comparison programs should be evaluated by personnel with meteorological expertise. Reasons for changes in the data resulting from the validation process should be documented. If system problems are identified, corrective actions should also be documented. Edited data should continue to be flagged so that their reliability can be considered in the interpretation of the results of modeling analyses for which the data are used.

Flags can be used in the field and at the data management center to signify data that may be suspect due to calibration or audit failure, special events, or failed QC limits. When calibration problems are identified, data produced between the suspect calibration event and subsequent recalibration should be flagged. Because flag combinations can be overwhelming and cannot always be anticipated, an organization needs to review these flag combinations to determine whether single values or values from a site over a particular time period should be invalidated. Procedures for screening data for possible errors or anomalies should also be implemented. When calibration problems are identified, data produced between the suspect calibration event and any subsequent recalibration should be flagged to alert data users.

Meteorological Data Screening Checklist

Monitoring Station _____

Month/Year _____

Data Screening Questions

_____ Was percent data recovery criteria met (i.e., greater than 75%)

_____ Do WSV & WDV have same data recovery?

_____ Do WSV and WDV have same hour invalid?

_____ Review missing data summary

_____ Review site logs.

_____ Multipoint calibration: WS slope = 1 ± 0.05 m/s, WD average difference = ± 5 degrees

_____ VWS maximum difference < 0.3 m/s, T maximum difference < 1 degree C?

_____ Are all calibrations documented?

_____ Vector WS \leq Average WS?

_____ Compare average WD to vector WD?

_____ Sigma phi calculation OK?

_____ Compare sigma W vs. VWS?

_____ Compare sigma V vs. $WS \cdot \sin(\text{sigma theta})$?

_____ Any hand reduced sigma or vector data?

_____ Check dependent parameters:

_____ WSA affects WSV, WDV, sigma phi, sigma V

_____ WDA affects WDV, WSV, sigma theta, sigma V

_____ VWS affects sigma W, sigma phi

Strip Charts (paper or digital)

_____ Random check of all meteorological parameters – (chart vs. data)

_____ Random check of all calibrations - (chart vs. data)

_____ Do sigma theta values and WD chart scatters coincide? Zero offset for WS OK?

_____ Check WS noise/bearings at threshold speeds

Figure 10.5 Example of a Meteorological Data Screening Checklist

11. New Technologies

Some of the latest technologies in meteorological sensors are described in this section. Examples of sensors from a variety of manufacturers are also provided. This summary of new technologies is not exhaustive, and mention of any manufacturers does not represent an endorsement of their products or services.

11.1 Wind – Anemometers

Sonic anemometers have been used by the research community for several years. Sonic anemometers measure components of the wind vector by determining the effect of the wind on transit times of acoustic pulses transmitted in opposite directions across known paths. Wind speed will increase or decrease the speed of sound depending on whether it is a tail wind or a head wind. Measuring the speed of sound in both directions along that one axis allows the wind speed to be calculated. A two-axis or three-axis sensor can then be used to calculate horizontal or horizontal plus vertical wind speed and wind direction. Table 11.1 lists a few examples of sonic anemometers.

Table 11.1 Example Sonic Wind Sensors

Manufacturer	Model	Accuracy	Resolution	Range	Data Output Rate	Power Supply Requirements
Gill Instruments	WindMaster/ WindMaster Pro	1% or 1.5% wind speed 0.5° or 2° wind direction	0.01 m/s wind speed 0.1° or 1° wind direction	0-65 m/s wind speed 0-359° wind direction	32Hz or 40 Hz	9-30 VDC, 55mA @ 12 VDC
Belfort	Belfort WindObserver II Ultrasonic	±2% wind speed ±2° wind direction	0.01m/s wind speed 1° wind direction	0-65 m/s wind speed 0-359° wind direction	1 Hz, 2 Hz, 4 Hz, 5 Hz, 8 Hz, 10 Hz	9-30 VDC, 14mA @ 12 VDC
RMYoung	81000	±1 % (1-30 m/s) ±3% (30-40 m/s) wind speed ±2° (1-30 m/s) ±5° (30-40 m/s) wind direction	0.01 m/s wind speed 0.1° wind direction	0-40 m/s wind speed 0-360° wind direction	4-32 Hz	12-24 VDC 110 mA
Vaisala	WXT510	±0.3 m/s or ± 3%, whichever is greater (0-35 m/s) ±5% 36-60 m/s)	0.1 m/s wind speed 1° wind direction	0-60 m/s wind speed 0-360° wind direction	1 Hz	5-30 VDC 3 mA @ 12 VDC
Climatronics	AIO	±0.5 m/s or 5% whichever is greater	0.1 m/s wind speed 1° wind direction	0-50 m/s wind speed 0-360° wind direction	1 Hz	10-18 VDC 50 mA

11.2 Temperature – Thermometers

Temperature measurements have not changed in the past several years. However, one company, Yankee Environmental Systems, Inc., has taken a modified four-wire Standard Platinum Resistance Thermometer (SPRT) and mounted it in an aspirated, triple-walled aluminum radiation shield that has a worst-case, full-sun, and radiation error of less than 0.05°C. Table 11.2 shows the details of this sensor.

Table 11.2 Example Thermometers

Manufacturer	Model	Accuracy	Range	Power Supply Requirements
Yankee Environmental Systems, Inc.	PMT-2005	±0.05°C	±50°C	11-14 VDC, 1.3 A
Vaisala	WXT510	±0.2°C	±50°C	5-30 VDC, 3 mA @ 12 VDC
Climatronics	AIO	±0.3°C at 20°	-52 °C to +60°C	10-18 VDC 50 mA

11.3 Pressure – Barometers

Climatronics

Climatronics Corporation introduced a new barometric pressure sensor based on a stable transducer utilizing nano-technology, resulting in a linear and repeatable sensor with low hysteresis. The sensor produces digital and analog signals that do not require signal conditioning. The sensor’s microcontroller applies a NIST-traceable temperature correction to the readings from the pressure sensor maximizing accuracy over a broad operating temperature range. Table 11.3 summarizes Climatronics’ barometric pressure sensor specifications.

PSI/Weston Aerospace

PSI/Weston Aerospace introduced a high-accuracy digital barometer. The PSI/Weston Aerospace vibrating cylinder air pressure transducer is designed to measure absolute air pressure using the vibrating element principle, providing a frequency output from which pressure is computed. The pressure is applied to a thin-walled metal cylinder, which is set into motion at its natural frequency by electromagnetic drivers. As the air pressure inside the cylinder changes, the resonant frequency of the cylinder also changes. This frequency is detected by electromagnetic pick-up coils that feed it back to the drive circuitry so as to maintain the resonant state. The “new” resonant frequency can then be equated to the absolute pressure. During manufacture, the transducer is calibrated by measuring the resonant frequency (time period) and diode voltage (temperature) across a matrix of 77 data points (11 pressures, 7 temperatures), covering the full working pressure and temperature ranges. Table 11.3 lists the details of the PSI/Weston Aerospace digital barometer.

Table 11.3 Barometric Pressure Sensors

Manufacturer	Model	Accuracy	Range	Power Supply Requirements
Climatronics Corporation	P/N 102663	± 0.35 mb @ 25°C	600-1100 mb	6-16 VDC, 10 mA @ 12 V
PSI/Weston Aerospace	DPM 7885-1A	$< \pm 1.1$ mb	600-1150 mb	11-18 VDC
Vaisala	WXT510	± 0.5 hPa (0 to +30°C) ± 1 hPa (-52 to +60°C)	600-1100 hPa	5-30 VDC 3 mA @ 12 VDC
Climatronics	AIO,	± 0.35 hPa	600-1100 hPa	10-18 VDC, 50 mA

11.4 Solar Radiation – Pyranometers

Pyranometer technology has not changed in the past several years. However, Kipp & Zonen and Hukseflux released some new designs.

Kipp & Zonen

Kipp & Zonen released a two-component net radiometer called the CNR2. The design of this instrument features separate outputs for short-wave (solar) and long-wave (atmospheric and terrestrial) radiation. The glass domes and silicon windows protect the thermopile detectors from environmental factors, are easy to clean, and minimize the effects of wind and rain. The CNR2 is designed for continuous outdoor use, and the operating temperature from -40°C to 80°C ensures that it can be used even in remote locations. Both short-wave and long-wave outputs supply a voltage proportional to, and generated by, the measured radiation. Therefore, the CNR 2 requires no power supply. The CNR2 specifications are listed in Table 11.4.

Hukseflux

Hukseflux introduced a new pyranometer, the SR11, that measures the solar radiation flux incident on a plane surface in W/m² from a 180-degree field of view (also called “global” solar radiation). Employing two glass domes, certain measurement errors are reduced, in particular thermal offsets, so that a high measurement accuracy can be attained. The detailed specifications of the SR11 are shown in Table 11.4.

Table 11.4 Example Pyranometers

Manufacturer	Model	Sensitivity	Range	Power Supply Requirements
Kipp & Zonen	CNR2	<10% (daily total)	310-2800 nm (pyranometer), 4.5-42 μ m (pyrogeometer)	0-50 mV (pyranometers) ± 5 mV (pyrogeometer)
Hukseflux	SR11	15 μ V/Wm ²	0-2000 W/m ²	Unknown

11.5 Precipitation – Rain Gauges

Two new precipitation-measuring technologies are currently available.

Lufft

The Lufft technology involves a radar rain sensor that works with a 24-GHz Doppler radar, which is used to measure the speed of precipitation droplets. The precipitation amount is calculated using the correlation between droplet size and speed. The specifications of the Lufft R²S are listed in Table 11.5.

Yankee Environmental Systems

Another new technology is the TPS-3100 Hotplate from Yankee Environmental Systems. About five inches in diameter, the sensor head consists of two isolated plates warmed by electrical heaters. During storms, it measures the rate of rain or snow by how much power is needed to evaporate precipitation on the upper plate and keep its surface temperature constant. The second plate is positioned directly under the evaporating plate and heated to the same temperature as the top, factoring out cooling from the wind. With no moving parts, the all-electronic TPS-3100 sensor avoids problems associated with traditional volumetric or weighing rain gauges. It works equally well in snow and rain conditions. Liquid equivalent rates are calculated from real time measurements and output in real time. The specifications of the TPS-3100 are listed in Table 11.5.

Table 11.5 Example Rain Gauges

Manufacturer	Model	Resolution	Range	Power Supply Requirements
Lufft	R ² S	0.01 mm/m ²	0.3-5 mm	10-15V, 100 mA
Yankee Environmental Systems	TPS-3100	0.1 mm/hr	0-50 mm/hr	110/220 VAC, 50/60 Hz
Vaisala	WXT510	0.1 mm/hr	0-200 mm/hr	5-30 VDC, 3 mA @ 12 VDC

11.6 Upper-Air Measurements

Some emerging technologies to measure aloft meteorological conditions include the Doppler lidar and the microwave radiometer.

Vaisala and Lockheed Martin

The Doppler lidar is a laser radar that can determine the radial velocity of the air (velocity toward or away from the laser beam) by measuring the frequency shift of the returning light that was scattered by atmospheric aerosols. Most lidar signals are blocked by clouds and greatly attenuated by polluted air. Table 11.6 lists some specifications of two autonomous lidars.

Kipp & Zonen

A microwave radiometer (MWR) measures the thermal radiation of the atmosphere at different elevation angles. Unique algorithms are used to retrieve the air temperature profile up to 1000 m above the instrument. Table 11.6 lists the specifications for the Kipp & Zonen MTP5 MWR.

Table 11.6 Example Upper-Air Measurement Devices

Manufacturer	Model	Type	Accuracy	Range	Range Resolution	Power Supply Requirements
Vaisala	CL31	Pulsed stationary lidar	Greater of $\pm 1\%$ or ± 5 m	0-7.5 km	5 m	100/115/230 VAC
Lockheed Martin	WindTracer	Pulsed scanning lidar	$\pm 30\%$ of actual backscatter coefficient	400 m-12 km	30-40 m	unknown
Kipp & Zonen	MTP5-HE	microwave radiometer (MWR)	$\pm 0.3^\circ\text{C}$ ($\pm 0.8^\circ\text{C}$ for inversion) @ 0-500 m, $\pm 0.4^\circ\text{C}$ ($\pm 1.2^\circ\text{C}$ for inversion) @ 500-1000m	0-1000 m	50 m to 120 m depending on height	110/220 VAC

11.7 Multiple Parameter Weather Sensor

Combining sonic wind technology with innovations to improve other sensors, manufacturers are offering instruments capable of measuring essential parameters in one compact unit.

Climatronics

The Climatronics All-In-One (AIO) compact weather station, shown in Figure 11.1, is the next-generation weather instrument that measure temperature, relative humidity, wind speed, wind direction, and barometric pressure in a single compact unit. The AIO uses an internal flux gate compass for automatic alignment of wind direction to magnetic north for quick deployment. The AIO specifications and literature are posted at <http://www.climatronics.com> and shown in Tables 11.1, 11.2, and 11.3.



Figure 11.1 Climatronics AIO

Vaisala

The Vaisala Weather Transmitter WXT510, shown in Figure 11.2, is a compact and lightweight multi-sensor instrument that measures wind speed and direction, liquid precipitation, barometric pressure, temperature, and relative humidity all in one transmitter. The WXT510 specifications are posted at <http://www.vaisala.com> and shown in Tables 11.1, 11.2, 11.3, and 11.5.



Figure 11.2 Vaisala WXT510

12. References

1. U.S. Environmental Protection Agency. "Quality assurance handbook for air pollution measurement systems. Volume IV, meteorological measurements"; EPA/600/4-90-003, out of print, Report prepared by the Office of Research and Development, Atmospheric Research and Exposure Assessment Laboratory, U.S. Environmental Protection Agency, Research Triangle Park, NC. 1983.
2. U.S. Environmental Protection Agency. "Quality assurance handbook for air pollution measurement systems. Volume IV, meteorological measurements"; EPA/600/R-94/038d, Report prepared by U.S. Environmental Protection Agency, Research Triangle Park, NC. 1995.
3. U.S. Environmental Protection Agency. "Guidance for the data quality objectives process (QA/G-4)"; EPA 240/B-06/001, Guidance document prepared by the U.S. Environmental Protection Agency, Research Triangle Park, NC. 2006.
4. U.S. Environmental Protection Agency. "Meteorological monitoring guidance for regulatory modeling applications"; EPA-454/R-99-005, Guidance document prepared by the Office of Air Quality Planning and Standards, Research Triangle Park, NC. 2000.
5. National Weather Service. "Instrument requirements and standards for the NWS surface observing programs"; NWSI 10-1302, 2005.
6. *Stealth telescoping poles*. GeoData Systems Management, Inc., 2007. Available at: <<http://www.geodatasys.com/pole1.htm>>.
7. *QTM Mast*. Clark Masts, 2007. Available at: <http://www.clarkmasts.com/qtm_masts.php>.
8. *MF-1300 series fold-over towers*. Glen Martin Enterprises, 2007. Available at: <<http://www.glenmartin.com/industrial/pg31.htm>>.
9. *T-175 Towers (standard duty aluminum crank-up towers)*. Aluma Tower Company, 2007. Available at: <<http://www.alumatower.com/new/PDFs/standard%20bro%20SD%20405.pdf>>.
10. *Installation instructions, towers and bases*. Climatronics Corporation, 2006. Available at: <<http://www.climatronics.com/Web%20Manuals/MC33%20Tower.pdf>>.
11. U.S. Environmental Protection Agency. "Meteorological monitoring guidance for regulatory modeling applications"; Document EPA-454/R-99-005, Office of Air Quality Planning and Standards, Research Triangle Park, NC, 2000.
12. World Meteorological Organization. *Guide to meteorological instruments and methods of observation*; Draft seventh edition ed.; Secretariat of the World Meteorological Organization; Geneva, Switzerland, 2006.
13. MacCready, P. B. "Wind speed measurements in turbulence", *J. Appl. Meteor.* 1966, 5, 219-225.

14. *Wind mark III wind sensor*. . Climatronics Corporation, Equipment specifications prepared by Climatronics Corporation, Bohemia, NY, , 2002. Available at: <http://www.climatronics.com/pdf/products/sensors/wind_mark3.pdf>.
15. *Meteorological instruments, wind sensors*. R.M. Young Company, 2006. Available at: <<http://www.youngusa.com>>.
16. Gill, G. C. "The helicoid anemometer", *Atmosphere* 1973, 11(4), 145-155.
17. *Environmental towers*. Aluma Tower Company, 2007. Available at: <<http://www.alumatower.com/new/environmental.html>>.
18. Campbell Scientific, Inc. "Weather station siting and installation tools"; App. Note Code: 4-S, Application notes prepared by Campbell Scientific, Inc., Logan, UT. 1997.
19. *Torque watches by Waters*. Deterco, Inc., 2007. Available at: <<http://www.deterco.com/products/Data%20Instruments/datainstruments.htm>>.
20. Blackadar, A. F. *Almanac for a weather station*; Heldref Publications; Washington, D.C., 1985.
21. U.S. Environmental Protection Agency. "Quality assurance handbook for air pollution measurement systems. Volume IV - meteorological measurements." EPA/600/R-94/038d, Appendix A prepared by the Office of Research and Development, Atmospheric Research and Exposure Assessment Laboratory, U.S. Environmental Protection Agency, Research Triangle Park, NC. 1995.
22. *Sun or moon altitude/azimuth table*. U.S. Naval Observatory, 2006. Available at: <<http://aa.usno.navy.mil/data/docs/AltAz.php>>.
23. Lockhart, T. J. "Accuracy of the collocated transfer standard method for wind instrument auditing", *J. Atmos. And Oceanic Technol.* 1989, 6, 715-723.
24. ASTM Standard D4430-00(2006). "Standard practice for determining the operational comparability of meteorological measurements"; prepared by Committee D22.11 on Meteorology, ASTM International, West Conshohocken, PA. 2006.
25. Lockhart, T. J. "Some cup anemometer testing methods", *J. Atmos. And Oceanic Technol.* 1985, 2, 680-683.
26. ASTM Standard D6011-96(2003). "Standard test method for determining the performance of a sonic anemometer/thermometer"; prepared by Committee D22.11 on Meteorology, ASTM International, West Conshohocken, PA. 2003.
27. Baxter, R. A.; Yoho, D. L.; Durkee, K. R. "Quality assurance audit program for surface and upper-air meteorological measurements in the South Coast Air Basin of California". In *Proceedings, Proceedings of the American Meteorological Society's 83rd Annual Meeting, 12th Symposium on Meteorological Observations and Instrumentation, Long Beach, CA, February 8-11, 2003*.

28. Robertson, J. H.; Katz, D. I. "Climatronics' novel sonic anemometer". In *Proceedings, Proceedings of the 9th Joint Conference on the Applications of Air Pollution Meteorology, January 28-February 2, Atlanta, GA, 1966*.
29. U.S. Environmental Protection Agency. "Ambient air quality surveillance; quality assurance requirements for SLAMS, SPMs and PSD; air monitoring calculations for data quality assessment"; Federal Register, Vol. 59 at page 41628; 40 CFR Part 58, Appendix A.4, August 12, 1994.
30. ASTM Standard D6176-97(2003). "Standard practice for measuring surface atmospheric temperature with electrical resistance temperature sensors"; prepared by Committee D22.11 on Meteorology, ASTM International, West Conshohocken, PA. 2003.
31. ASTM Standard E1-05. "Standard specification for ASTM liquid-in-glass thermometers"; prepared by Committee E20.05 on Liquid-in-Glass Thermometers and Hydrometers, ASTM International, West Conshohocken, PA. 2005.
32. U.S. Environmental Protection Agency. "Ambient monitoring guidelines for prevention of significant deterioration (PSD)"; EPA-450/4-97-007, Report prepared by Office of Air Quality Planning and Standards, U.S. Environmental Protection Agency, Research Triangle Park, NC. 1987.
33. ASTM Standard D4230-02e1. "Standard test method of measuring humidity with cooled-surface condensation (dew-point) hygrometer"; prepared by Committee D22.11 on Meteorology, ASTM International, West Conshohocken, PA. 2002.
34. ASTM Standard E1137/E1137M-04. "Standard specification for industrial platinum resistance thermometers"; Committee E20.03 on Resistance Thermometers, ASTM International, West Conshohocken, PA 2004.
35. Weiss, L. L. "Relative catches of snow in shielded and unshielded gauges at different wind speeds", *Mon. Wea. Rev.* 1961, 89.
36. National Physical Laboratory. *A guide to the measurement of humidity*; Institute of Measurement and Control and National Physical Laboratory London, England, 1996.
37. ASTM Standard E337-02. "Standard test method for measuring humidity with a psychrometer (the measurement of wet- and dry-bulb temperatures)"; prepared by Committee D22.11 on Meteorology, ASTM International, West Conshohocken, PA. 2002.
38. ASTM Standard E104-02 "Standard practice for maintaining constant relative humidity by means of aqueous solutions"; prepared by Committee D22.11 on Meteorology, ASTM International, West Conshohocken, PA. 2002.
39. ASTM E816-05. "Standard test method for calibration of pyrhemometers by comparison to reference pyrhemometers"; prepared by Committee G03.09 on Radiometry, ASTM International, West Conshohocken, PA. 2005.

40. Latimer, J. R. *Radiation measurement*; The Secretariat, Canadian National Committee for the International Hydrological Decade, 1972.
41. Liu, H.; Darkow, G. "Wind effect on measured atmospheric pressure", *J. Atmos. And Oceanic Technol.* 1989, 6(1), 5-12.
42. Miksad, R. "An omni-directional static pressure probe", *J. Meteor. Society of Japan* 1976, 15, 1215-1225.
43. U.S. Weather Bureau *Manual of barometry (WBAN)*; First ed.; U.S. Government Printing Office; Washington, D.C, 1963.
44. Beyrich, F. "Mixing height estimation from Sodar data - a critical discussion", *Atmos. Environ.* 1997, 31, 3941-3953.
45. Holzworth, G. "Mixing heights, wind speeds, and potential for urban air pollution throughout the contiguous United States"; Publication No. AP-101, prepared by the Office of Air Programs, U.S. Environmental Protection Agency, Research Triangle Park, NC. 1972.
46. Gaynor, J. E. "Accuracy of Sodar wind variance measurements", *Int. J. Remote Sens.* 1994, 15, 313-324.
47. van de Kamp, D. W. "Profiler training manual #2: quality control of wind profiler data"; Report prepared for the National Weather Service Office of Meteorology by NOAA/WPL, Boulder, CO. 1988.
48. Ecklund, W. L.; Carter, D. A.; Balsley, B. B. "A UHF wind profiler for the boundary layer: brief description and initial results", *J. Atmos. Ocean. Technol.* 1988, 5, 432-441.
49. *The WGS84 System*. Rizos, C., Satellite Navigation & Positioning Laboratory, University of New South Wales, Australia, 1999. Available at: <http://www.gmat.unsw.edu.au/snap/gps/gps_survey/chap2/214.htm>.
50. Thuillier, R. H. "The influence of instrumentation, siting, exposure height, and temporal averaging methodology on meteorological measurements from SJVAQS/AUSPEX", *J. Appl. Meteor.* 1995, 34, 1815-1823.
51. Crescenti, G. H. "The degradation of Doppler Sodar performance due to noise: a review", *Atmos. Environ.* 1998, 32, 1499-1509.
52. Crescenti, G. H. "Examples of noise interference on Doppler Sodar performance". In *Proceedings, Proceedings of the Tenth Symposium on Meteorological Observations and Instrumentation: Phoenix, AZ, January 11-16, , 1998*.
53. Baxter, R. A. "Development of a universal acoustic pulse transponding system for performance auditing of Sodars". In *Proceedings, Proceedings of the 7th International Symposium on Acoustic Remote Sensing and Associated Techniques of the Atmosphere and Oceans, Boulder, CO, October, 1994*, pp 3-35-33-40.

54. U.S. Environmental Protection Agency. "Quality assurance handbook for air pollution measurement systems. Volume I, a field guide to environmental quality assurance"; EPA/600/R-94/038a, report prepared by U.S. Environmental Protection Agency, Research Triangle Park, NC. 1994.
55. Wilczak, J. M.; Strauch, R. G.; Weber, B. L.; Merritt, D. A.; Ralph, F. M.; Jordan, J. R.; Wolfe, D. E.; Lewis, L. K.; Wuertz, D. B.; Gaynor, J. E.; McLaughlin, S.; Rogers, R.; Riddle, A.; Dye, T. "Contamination of wind profiler data by migrating birds: characteristics of corrupted data and potential solutions", *J. Atmos. Ocean. Technol.* 1995, 12(3), 449-467.
56. Gauthreaux, S. A., Jr. "The flight behavior of migrating birds in changing wind fields: radar and visual analyses", *Amer. Zool.* 1991, 31, 187-204.
57. Gaynor, J. E. "Siting guidance for boundary layer meteorological profilers", Presented at Air & Waste Management Association Specialty Conference on Air Toxics, Durham, NC, 1994
58. Miller, P. A.; Schlatter, T. W.; van de Kamp, D. W.; Barth, M. F.; Weber, B. L. "An unfolding algorithm for profiler winds", *J. Atmos. Ocean. Technol.* 1994, 11, 32-41.
59. Riddle, A. C.; Angevine, W. M.; Ecklund, W. L.; Miller, E. R.; Parsons, D. B.; Carter, D. A.; Gage, K. S. "In situ and remotely sensed horizontal winds and temperature intercomparisons obtained using Integrated Sounding Systems during TOGA COARE", *Atmos. Phys.* 1996, 69, 49-61.
60. Baxter, R. A. "Evaluation of the wind data collected using different USEPA approved calculation algorithms ", Presented at the 9th Symposium on Meteorological Observations and Instrumentation, Charlotte, NC, March 27-31, 1995
61. Mueller, P. K.; Watson, J. G. "Eastern regional air-quality measurements. Volume 1, Section 7"; EPRI-EA-1914-Vol.1, final report prepared for Environmental Research and Technology, Inc., Concord, MA, by Electric Power Research Institute, Palo Alto, CA. 1982.
62. Watson, J. G.; Liroy, P. J.; Mueller, P. K. "The measurement process: precision, accuracy, and validity". In *Proceedings, Proceedings, Air Sampling Instruments for Evaluation of Atmospheric Contaminants*; 7th ed.; Hering, S. V., Ed.; American Conference of Governmental Industrial Hygienists: Cincinnati, OH, 1989, pp 51-57.

Appendix A

Meteorological Systems Audit Evaluation Form

This appendix contains a meteorological systems audit evaluation form to be used as a guideline to evaluate the operation and exposure of meteorological sensors and overall condition of a monitoring site.

Meteorological Systems Audit Evaluation Form

This site systems audit form can be used as a guideline to evaluate the operation and exposure of meteorological sensors and overall condition of a monitoring site. System audits should be performed on a yearly basis.

I. On Site Equipment and Location

A. Meteorological Parameters On-site

Parameter	Manufacturer	Model #	Serial #	Range

1. Are there any required parameters which are not monitored? _____
2. Are any methods and equipment unacceptable? _____
3. Are any operating ranges improper? _____
4. Are there any significant differences between instrumentation on site and the monitoring plan? _____
5. What is the GPS coordinates for this monitoring site _____ N _____ W
6. Does the site have an AQS Site Code? _____
7. What is the magnetic Declination at this site? _____

Comments:

B. Auxiliary Equipment

Type	Manufacturer	Model #	Serial #	Calibration Date
DAS System				
Chart Recorder				
Chart Recorder				
Meteorological Tower				
Monitor Shelter				
Computer				
Power Conditioner				
WS motors				
Compass				
Thermometer				
Psychrometer				
Precipitation Gauge				
Solar Radiation				

Comments.

II. Instrument Height and Exposure

A. Meteorological Distance

Parameter	Distance	Meets Regulations	
		Yes	No
1. Height of WS sensor above ground			
2. Height of WD sensor above ground			
3. Height of VWS sensor above ground			
4. Distance to nearest obstacle			
5. Is exposure outside 10X obstruction height			
5a. Are instruments on a rooftop?			
5b. Is exposure 1.5X height above the roof?			
6. Arc of unrestricted flow?			
7. Height of temperature sensor above ground			
8. Distance of temperature sensor from obstacles			
9. Is the distance 4X from obstruction height?			
10. Arc of unrestricted air flow			
11. Distance to nearest paved road			
12. Is temperature sensor shielded/motor aspirated?			
13. Height of precipitation gauge above structure			
14. Distance to nearest obstacle			
15. Is exposure outside 2-4X obstruction height?			
16. Height of solar radiation above structure			
17. Distance to nearest obstacle			
18. Will solar radiation sensor fall within a shadow			
19. Height of dew point sensor above structure			
20. Distance to nearest obstacle			
21. Is exposure outside 2-4X obstruction height			
22. Is temperature sensor below representative terrain?			
23. Is temperature sensor pointed downward?			
Are there any significant differences between on-site equipment and the monitoring plan?			

Comments:

III. Operations

A. Meteorological Equipment

Parameter	Yes	No
1. Are all WS, WD sensors operational?		
2. Is the temperature probe and aspirated shield operational?		
3. Is precipitation gauge operational and clean?		
4. Is dew point sensor operational?		
5. Is meteorological tower perpendicular to the ground?		
6. Are all booms level?		
7. Are all cables secure?		
8. Are connections clean and rust-free?		
9. Are vanes/cups/propellers intact?		
10. Are serial numbers available?		
11. Are WS/WD bearings free?		
12. Is the solar radiation sensor operation?		
13. Are the chart traces clear and easily read?		
14. Are all chart recorders times correct?		
15. Is DAS operational?		
16. Are the sigma values being collected?		
17. Are vector values being collected?		
18. Is the printer functional?		
19. Is hard copy data printout available?		
20. Are torque tests being performed on WS/WD sensors?		
21. Overall, is the site well maintained?		

Comments:

B. Auxiliary Equipment

Parameter	Yes	No
1. Is the A/C unit operational?		
2. Is the shelter temperature system operational?		
3. Is the shelter temperature recorded?		
4. Is the shelter temperature maintained at 20-30°C?		
5. Is the shelter and outside surroundings clean?		
6. Does modem work?		
7. Does telephone work?		
8. Is the site secure?		
9. Overall, is meteorological and auxiliary equipment well maintained?		

Comments:

C. Procedures

Parameter	Yes	No
1. Are the station logs present?		
2. Are the station logs up to date?		
3. Are station logs detailed?		
4. Are routine checklists used?		
5. Are the routine checklists detailed?		
6. Are the calibration forms present?		
7. Are the calibration forms detailed?		
8. Are the EPA guidelines present?		
9. Are QA/QC manuals present?		
10. Is the monitoring plan present?		
11. Is the site technician knowledgeable of meteorological equipment operation?		
12. Are the strip charts annotated each visit?		
13. Are charts annotated with date and time?		
14. Are sensor calibrations performed every six months?		
15. Does the site technician have a working knowledge of EPA guidelines?		
16. Does the site technician have working knowledge of QAPP?		

Parameter	Yes	No
17. Does the site technician have a working knowledge of Monitoring Plan?		
18. Does the monitoring plan have site ID forms?		
19. Does the monitoring plan have site map and photos?		

Comments:

D. Preventive Maintenance

Parameter	Yes	No
1. Is preventive maintenance discussed in the QA/QC plan?		
2. Are field operators given special training for preventive maintenance?		
3. Is the training re-enforced?		
4. Review preventive maintenance worksheets or logs acceptable?		
5. Please provide the frequency of calibration for the following:		
6. Are parts and tools available to site operators?		
7. List any persistent problems with equipment.		
8. Are preventive maintenance log books maintained?		
9. Does senior staff or management review the logs?		
10. Does data processing staff review the logs?		

Comments:

E. Chain of Custody

D. Chain of Custody

1. Review paper work for chain of custody from field to data processing. _____
2. How is data stored? _____
3. How often is the data logger dumped? _____ By Whom? _____

Appendix B

Examples of Meteorological Sensor Calibration Forms

This appendix contains examples of meteorological calibration forms for field use.



**Environmental Protection Agency
 Meteorological Calibration/Audit Form**

Site Name/Location _____
 Station Operator _____
 Auditor _____
 Date: _____
 GPS Coordinates _____

Wind Speed Sensor

Instrument Make/Model _____ Serial Number _____ Range _____
 Audit Device Make/Model _____ Serial Number _____ Range _____

Torque Test _____ g-cm

Audit Point (rpm)	Audit Value (m/s)	DAS Response (m/s)	Difference (m/s)	Chart Response (m/s)	Difference (m/s)	Pass/Fail?
0						

Wind Direction Sensor

Instrument Make/Model _____ Serial Number _____ Range _____
 Audit Device Make/Model _____ Serial Number _____ Range _____
 Magnetic Declination _____ deg. Torque Test _____ g-cm Cross Arm Reference _____ deg.

Audit Point (deg)	DAS Response (deg)	Difference (deg)	Chart Response (deg)	Difference (deg)	Pass/Fail?

Comments



**Environmental Protection Agency
Meteorological Calibration/Audit Form**

Site Name/Location _____
Station Operator _____
Auditor _____
Date: _____
GPS Coordinates _____

Atmospheric Temperature Sensor

Instrument Make/Model _____ **Serial Number** _____ **Range** _____
Audit Device Make/Model _____ **Serial Number** _____ **Range** _____
Type of Aspirator _____

Audit Point (deg. C)	Audit Value (deg. C)	DAS Response (deg. C)	Difference (deg. C)	Chart Response (deg. C)	Difference (deg. C)	Pass/Fail?

Relative Humidity Sensor

Instrument Make/Model _____ **Serial Number** _____ **Range** _____
Audit Device Make/Model _____ **Serial Number** _____ **Range** _____

Dry Audit Point (deg)	Value	Pass/Fail?
Dry Temp (Thermometer)		
Dry Temp (DAS)		
Wet Temp. (Thermometer)		
RH (Calculated)		
RH Reported (DAS)		

Comments

Date	

Appendix C

Meteorological Measurement Methods Validation Criteria

[From the State of Alaska Department of Environmental Conservation, Division of Air Quality]

The Meteorological Measurement Methods Validation Criteria should be used for the following purposes:

- To provide a "look-up" table of all the significant quality control criteria important for the proper implementation of the Meteorological Measurement methods, and
- As a tool for validating Meteorological Measurement data.

In order to accomplish both objectives the quality control criteria are organized into the following three classes/tables:

1. **Critical Criteria Table,**
2. **Operational Evaluations Table, and**
3. **Systematic Issues Table.**

Criteria that were deemed critical to maintaining the integrity of a sample or group of samples were placed on the first table. Observations that do not meet each and every criterion on the **Critical Criteria Table** should be invalidated unless there are compelling reason and justification for not doing so. Basically, the sample or group of samples for which one or more of these criteria are not met is invalid until proven otherwise. The cause of not operating in the acceptable range for each of the violated criteria must be investigated and minimized to reduce the likelihood that additional samples will be invalidated.

Criteria that are important for maintaining and evaluating the quality of the data collection system are included on the second table, the **Operational Evaluations Table**. Violation of a criterion or a number of criteria may be cause for invalidation. The decision should consider other quality control information that may or may not indicate the data are acceptable for the parameter being controlled. Therefore, the sample or group of samples for which one or more of these criteria are not met is suspect unless other quality control information demonstrates otherwise. The reason for not meeting the criteria **MUST** be investigated, mitigated or justified.

Finally, those criteria which are important for the correct interpretation of the data but do not usually impact the validity of a sample or group of samples are included on the third table, the **Systematic Issues Table**. For example, the data quality objectives are included in this table. If the data quality objectives are not met, this does not invalidate any of the samples but it may impact the error rate associated with the attainment/non-

attainment decision.

CRITICAL CRITERIA TABLE – METEOROLOGICAL MEASUREMENT METHODS

S - single instrument hourly value, G - group of hourly values from 1 instrument

Parameter	Criteria	Acceptable Range								Frequency	Samples Impacted	EPA -454/R-99-005 Feb 2000	EPA Regulation & Guidance	ADEC AM&QA QAPP
Method		Measurement Method Characteristics												
		Reporting Units	Range	Accuracy	Resolution	Starting Speed	Distance Constant	Sampling Frequency	Raw Data Collection Frequency					
Wind Speed (WS)	Cup, blade, or heated sonic anemometer	m/s	0.5 m/s – 50 m/s	± 0.2 m/s	0.25 m/s	≤ 0.5 m/s	≤ 0.5 m @ 1.2 kg/m ³	hourly	1 minute	All Data	Chapter 2 Sec 1 & 8, Chapter 5 Sec 1 & 2 Chapter 8 Sec 1	QA Handbook Vol IV Section 0 Tables 0-3, 0-4, 0-5, 0-6	Section 7 Table A8	
Vertical WS (VWS)			-25 m/s – +25 m/s	± 0.2 m/s	0.1 m/s	≤ 0.25 m/s	≤ 0.5 m @ 1.2 kg/m ³	hourly	1 minute	All Data				
							Damping Ratio						Delay Distance	
WD (azimuth & elevation)	Vane or heated sonic anemometer	Degrees (°)	1° – 360° or 540°	± 5 degrees	1.0 degree	≤ 0.5 m/s @ 10 degrees	0.4 to 0.7 @ 1.2 kg/m ³	hourly	1 minute	All Data			≤ 0.5 m @ 1.2 kg/m ³	
						Time Constant	Spectral Response							
Ambient Temp	Thermistor 10m – 2m	Degrees Celsius (°C)	-40°C to +40°C	± 0.5°C	0.1°C	≤ 1 minute		hourly	1 minute	All Data	Chapter 2 Sec 3 & 8,	Section 7 Table A8		
Vertical Temp Difference (ΔT)				-40°C to +40°C	± 0.1°C	0.02°C	≤ 1 minute		hourly	1 minute	All Data		Chapter 3 Sec 6 Chapter 5 Sec 1 & 2 Chapter 8 Sec 1	
Dew Point Temperature	Psychrometer/ Hygrometer %	°C	-40°C to +40°C	± 1.5°C	0.1°C	≤ 30 minutes		hourly	1 minute	All Data	Chapter 2 Sec 4 & 8, Chapter 5 Sec 1 & 2			
Relative Humidity/			%	0 – 100%	± 7%	0.5 %	≤ 30 minutes		hourly	1 minute		All Data		
Barometric Pressure (BP)	Aneroid Barometer	mb	950 mb to 1050 mb Hg	± 3 mb Hg (0.3 kPa)	0.5 mb Hg			hourly	1 minute	All Data	Chapter 2 Sec 6 & 8, Chapter 5 Sec 1 & 2			

CRITICAL CRITERIA TABLE – METEOROLOGICAL MEASUREMENT METHODS

S - single instrument hourly value, G - group of hourly values from 1 instrument

Parameter	Criteria	Acceptable Range							Frequency	Samples Impacted	EPA -454/R-99-005 Feb 2000	EPA Regulation & Guidance	ADEC AM&QA QAPP
		Watts/m ²	0 - 1300	± 5% of observed	10 W/m ²	5 seconds	285 nm to 2800 nm	hourly					
Solar Radiation	Pyranometer										Chapter 2 Sec 7 & 8, Chapter 5 Sec 1 & 2		
Precipitation	Tipping Bucket (with Alter type windscreen & heater)	mm H ₂ O	0 – 50 mmH ₂ O/hr	± 10% of observed or ± 0.5	0.3 mm H ₂ O			hourly	1 minute	All Data	Chapter 2 Sec 5 & 8, Chapter 5 Sec 1 & 2		
	Method	Measurement Method Characteristics (continued)											
		Reporting Units	Range	Accuracy	Resolution			Sampling Frequency	Raw Data Collection Frequency				
Vector Data WS	DAS Calculation	m/s	0 – 50.0 m/s	± 0.2 m/s	0.1 m/s			hourly	1 minute	All Data	Chapter 4 Section 6 Chapter 8	QA Handbook Vol IV Section Tables 0-3, 0-4, 0-5, 0-6	
Vector Data WD	DAS Calculation	Degrees (°)	0 - 360°	± 5°	1.0°			hourly	1 minute	All Data	Chapter 4 Section 6 Chapter 8		
sigma theta (σθ)	DAS Calculation SD of azimuth angle of WD	Degrees (°)	0 - 105°	± 5°	1.0°			hourly	15 minute	All Data	Chapter 4 Section 6 Chapter 8		Section 7 Table A8
sigma phi (σW)	DAS Calculation SD of vertical component of WS	m/s	0 – 10 m/s	± 0.2 m/s	0.1 m/s			hourly	1 minute	All Data	Chapter 4 Section 6 Chapter 8		Section 7 Table A8
		Radiation Range	Flow Rate	Radiation Error	Type	Estimates of Means		Estimates of Variance					
	Motor aspirated temp radiation shield (T, Δ,T RH/Dew Point)	-100 to 1300 W/m ²	≥ 3 m/s	< 0.2°C							Chap 2 Sec 3 & 4 Chapter 8 Sec 1		
Data Acquisition System (DAS)					Microprocessor-based digital	1/min for hourly mean (60 samples/hour)		6 samples/minute for hourly variance (360 samples/hour)			Chapter 4 Section 6 Chapter 8		
	Reporting Intervals												

CRITICAL CRITERIA TABLE – METEOROLOGICAL MEASUREMENT METHODS

S - single instrument hourly value, G - group of hourly values from 1 instrument

Parameter	Criteria	Acceptable Range	Frequency	Samples Impacted	EPA -454/R-99-005 Feb 2000	EPA Regulation & Guidance	ADEC AM&QA QAPP
All parameters	Hourly average		Quarterly	All	Chapter 5 Section 1		Section 7
	Data Completeness						
All parameters	Valid data capture	$\geq 75\%$	Hourly	G	Chapter 5 Sections 3 & 4	QA Handbook Vol IV Section 0 Tables 0-3, 0-4, 0-5, 0-6	Section 7 18 AAC 50.010
	(PSD Quality Monitoring) Valid data capture	$\geq 90\%$ hourly data, joint collection of WS, WD, and stability (SRDT, $\sigma\theta$, or σ_w depending upon model selection)	Quarterly (4 consecutive quarters)	G			
	Calibration						
WS, VWS	<u>Multi-point Calibration</u>	5 points including zero, 2 m/s and 3 additional evenly spaced upscale points covering expected wind speeds for the site All test points $\leq \pm (2 \text{ m/s} + 5\% \text{ of observed})$ WS bearing torque threshold \leq PSD quality sensor's manufacturer's specs	Initially, 1/6 months thereafter	G	Chapter 5	QA Handbook Vol IV, All Sections and 0 Tables 0-3, 0-4, 0-5, 0-6	Section 7 MQO Table A8
WS/WD Sonic Anemometer	<u>Multi-point Calibration</u>	Multipoint calibration via wind tunnel by manufacturer	Initially, 1/year thereafter				
WD, VWD	<u>Multi-point Calibration</u>	Alignment to True North + linearity test points at: 0°, 45°, 90°, 135°, 180°, 225°, 270°, 315°, 360° Alignment $\leq \pm 5^\circ$ Linearity (All Points) $\leq \pm 3^\circ$ (included in $\leq \pm 5^\circ$ above) WD bearing torque threshold \leq PSD quality sensor's manufacturer's specs	Initially, 1/6 months thereafter	G	Chapter 5 Chapter 8		

CRITICAL CRITERIA TABLE – METEOROLOGICAL MEASUREMENT METHODS

S - single instrument hourly value, G - group of hourly values from 1 instrument

Parameter	Criteria	Acceptable Range	Frequency	Samples Impacted	EPA -454/R-99-005 Feb 2000	EPA Regulation & Guidance	ADEC AM&QA QAPP
Temp	<u>Multi-point Calibration</u>	Minimum 3 point calibration representative of min avg low to max avg high temps for the location. (e.g., -30°C, 0°C, +30°C) Each point $\leq \pm 0.5^\circ\text{C}$ of NIST Traceable Standard	Initially, 1/6 months thereafter	G	Chapter 5 Chapter 8		MQO Table, Table A8 Section 16
ΔT	<u>Multi-point Calibration</u>	Side-by-side calibration of 10m and 2m temp probes with a Minimum 3 point calibration representative of min avg low to max avg high temps for the location. (e.g., -30°C, 0°C, +30°C) Each point $\leq \pm 0.5^\circ\text{C}$ of NIST Traceable Standard and 10m sensor $\leq \pm 0.1^\circ\text{C}$ of 2 m sensor at all points	Initially, 1/6 months thereafter	G	Chapter 5 Chapter 8		MQO Table, Table A8 Section 16
RH/Dew point	<u>Multi-point Calibration</u>	Factory multi-point calibration followed by on-site 1-point verification of RH/DP sensor against NIST Traceable RH Standard ($\pm 2\%$ RH accuracy) RH sensor $\leq \pm 7\%$ of RH Standard	Initially, 1/6 months thereafter	G	Chapter 5 Chapter 8		MQO Table, Table A8 Section 16
Solar Radiation (SR)	<u>Multi-point Calibration</u>	Factory multi-point calibration followed by on-site zero check with opaque cover 1-point verification against in-cert. First Class collocated Pyranometer SR sensor $\leq \pm 5\%$ of First Class Pyranometer	Initially, 1/6 months thereafter	G	Chapter 5 Chapter 8		MQO Table, Table A8 Section 16
Barometric Pressure (BP)	<u>Multi-point Calibration</u>	Factory multi-point calibration followed by on-site 1-point verification against pressure standard of known quality (see pressure std. min requirements) BP sensor $\leq \pm 3 \text{ mb (0.3 kPa)}$	Initially, 1/6 months thereafter	G	Chapter 5 Chapter 8		MQO Table, Table A8 Section 16
Precipitation	<u>Multi-point Calibration</u>	Minimum 3 point calibration Each point $\leq \pm 10\%$ of measured H_2O input, or $\leq \pm 5 \text{ mm H}_2\text{O}$	Initially, 1/6 months thereafter	G	Chapter 5 Chapter 8	QA Handbook Vol IV Sec 4 and Sec 0 Tables 0-3, 0-4, 0-5, 0-6	MQO Table, Table A8 Section 16
Vector Data/DAS (WS, WD, $\sigma\theta$, $\sigma\omega$)	<u>Multi-point Calibration</u>	Calibrate/check DAS voltage input against sensor inputs WS, $\sigma\omega \leq \pm 0.2 \text{ m/s}$ WD $\leq \pm 5^\circ$	Initially, 1/6 months thereafter	G	Chapter 5 Chapter 8	QA Handbook Vol IV Sec 9 and Sec 0 Tables 0-3, 0-4, 0-5, 0-6	

OPERATIONAL EVALUATIONS TABLE – METEOROLOGICAL MEASUREMENT METHODS

S - single instrument hourly value, G - group of hourly values from 1 instrument

Parameter	Criteria	Acceptance Range	Frequency	Samples Impacted	EPA -454/R-99-005 Feb 2000	EPA Regulation & Guidance	ADEC AM&QA QAPP
Siting & Exposure Criteria							
All met parameters	Representativeness	Site must be representative for the intent of the monitoring scale , No prescribed quantitative criteria See references	All	All	Chapter 3 Sec 1	QA Handbook Vol IV , Section 10-6	
All met parameters	Probe Siting	<i>See references for specific siting criteria for simple, complex, coastal and urban terrain locations</i>	All	All	Chapter 3 Sec 2 & 3		
Calibration/Audit Standards							
WS/ VWS	WS standard Sonic Anemometers calibrated @ factory	NIST Traceable Synchronous motor, or Series of NIST Traceable constant speed motors to generate WS in range of 2 m/s thru 50 m/s	Purchase, recalibrate 1/year or at frequency dependent upon use	G		QA Handbook Vol IV Section 0 Tables 0-3, 0-4, 0-5, 0-6 Section 2	Sections 16
WS/WD	Collocated Transfer Standard (CTS) for sonic anemometer audits	CTS must be cup/vane or aerovane anemometer that is calibrated on-site with standards/personnel independent from routine operator/calibration staff and equipment/standards. CTS must meet all PSD quality criteria	Purchase, Calibrate CTS on site prior to conducting each site audit, and CTS collocated for 72 hr minimum	G			
WD/VWD	WD Standard	<p>Alignment to True North</p> <ul style="list-style-type: none"> Solar Noon method, and or Transit & Compass, map, and site magnetic declination, or GPS accuracy ≤ 3 meters with lock on minimum 3 satellite signals <p>Linearity</p> <p>Linearity wheel with evenly spaced preset markings, e.g., 0°, 45°, 90°, 135°, 180°, 225°, 270°, 315°, 360°</p>	Purchase, recalibrate 1/year or at frequency dependent upon use	G			

OPERATIONAL EVALUATIONS TABLE – METEOROLOGICAL MEASUREMENT METHODS

S - single instrument hourly value, G - group of hourly values from 1 instrument

Parameter	Criteria	Acceptance Range	Frequency	Samples Impacted	EPA -454/R-99-005 Feb 2000	EPA Regulation & Guidance	ADEC AM&QA QAPP
Temperature	Thermister	<ul style="list-style-type: none"> measurement range -50°C to + 40°C Accuracy $\leq \pm 0.2^\circ\text{C}$ NIST traceable certified over -30°C to +30°C Resolution $\leq 0.1^\circ\text{C}$ 	Purchase, recertify 1/year or per NIST/ASTM certification frequency	G		QA Handbook Vol IV Section 3, and Section 0 Tables 0-3, 0-4, 0-5, 0-6	
RH/Dew Point	RH meter or Assman Style Psychrometer	<p style="text-align: center;">RH meter</p> NIST Traceable Standard $\pm 2\%$ RH Assman Style Psychrometer with matched pair NIST Traceable/ASTM Thermometers with measurement Resolution 0.1°C each and appropriate temp range No Sling Psychrometer Acceptable	Purchase, recertify 1/year or per NIST traceable certification frequency	G		QA Handbook Vol IV, Section 5 and Section 0 Tables 0-3, 0-4, 0-5, 0-6	
Solar Radiation	NIST Traceable Pyranometer	<p style="text-align: center;">First Class Pyranometer</p> Measurement range Measurement resolution Measurement accuracy	Purchase, recertify 1/year or per NIST traceable certification frequency	G		QA Handbook Vol IV Section 6, and Section 0 Tables 0-3, 0-4, 0-5, 0-6	Sections 16
Barometric Pressure	NIST Traceable Aneroid Barometer	Measurement accuracy $\pm 1\text{mb}$, Measurement resolution 0.1mb , Measurement range $950 - 1050\text{mb}$	Purchase, verify 1/year against NWS-FAA or NIST Traceable Std. or per NIST traceable certification frequency	G		QA Handbook Vol IV Section 7, and Section 0 Tables 0-3, 0-4, 0-5, 0-6	
Precipitation	Separatory funnel, graduated cylinder, and deionized water	<p style="text-align: center;">Volumetric Glassware</p> Calibrated (50ml or 100 ml, 1 ml divisions), and Deionized H₂O	Purchase	G		QA Handbook Vol IV Section 5, and Section 0 Tables 0-3, 0-4, 0-5, 0-6	
	Visual QC Checks-Field						
	Sky Check	Note & Record sky conditions (cloud cover, temp/WS/WD, etc estimates)	Each site visit	G		QA Handbook Vol IV Section 10.2	
WS	WS sensor	Moving freely, no visual damage	Each site visit	G			

OPERATIONAL EVALUATIONS TABLE – METEOROLOGICAL MEASUREMENT METHODS

S - single instrument hourly value, G - group of hourly values from 1 instrument

Parameter	Criteria	Acceptance Range	Frequency	Samples Impacted	EPA -454/R-99-005 Feb 2000	EPA Regulation & Guidance	ADEC AM&QA QAPP
WD	WD sensor	Moving freely, no visual damage	Each site visit	G			
Temperature, ΔT	Temperature sensors and aspirated temperature shields	No visual damage or obstruction, Motor in aspirated shield working	Each site visit	G			
SR	Solar Radiation Sensor	Radiometer/pyranometer face clear of dirt/debris/snow	Each site visit	G			
BP	Pressure sensor	No visual damage or obstruction	Each site visit	G			
RH	RH sensor, aspirated shield	S	Each site visit	G			
Precipitation	Precipitation sensor	No visual damage or obstruction, free of ice and snow, Heater working	Each site visit	G			
DAS	Data Acquisition System	DAS time ≤ 1 minute NIST Alaska Standard aaTime1	Each site visit	G			
Data Screening Criteria							
WS/ VWS	Hourly Recorded WS	0 m/s ≥ WS ≤ 25 m/s0, WS varies ≥ 0.1 m/s/3 consecutive hours, WS varies ≥ 0.5 m/s/12 consecutive hours, or per site specific climatology criteria	1/week or more frequent	G	Chapter 8, Table 8-4	QA Handbook Vol IV Section 10.4	
WD/VWD	Hourly Recorded WD	0° ≥ WD ≤ 360°, WD varies ≥ 1°/3 consecutive hours, or per site specific climatology criteria	1/week or more frequent	G	Chapter 8, Table 8-4		
Temperature	Hourly Recorded Ambient Temperature	Local record low ≥ Temp ≤ local record high, Temp ≤ 5°C from previous hourly record, Temp varies ≥ 0.5°C/12 consecutive hours, or per site specific climatology criteria	1/week or more frequent	G	Chapter 8, Table 8-4		
10m – 2 m ΔT	Hourly Recorded 10m – 2m Temperature Difference	Day time ΔTemp < 0.1°C/m, Night time ΔTemp > -0.1°C/m, -3.0°C > ΔT < 5.0°C, or Per site specific climatology criteria	1/week or more frequent	G	Chapter 8, Table 8-4		

OPERATIONAL EVALUATIONS TABLE – METEOROLOGICAL MEASUREMENT METHODS

S - single instrument hourly value, G - group of hourly values from 1 instrument

Parameter	Criteria	Acceptance Range	Frequency	Samples Impacted	EPA -454/R-99-005 Feb 2000	EPA Regulation & Guidance	ADEC AM&QA QAPP
RH/Dew Point	Hourly Recorded Relative Humidity	Dew Point Temp ≤ Amb Temp for time period, Dew Point Temp < 5°C change from previous hour, Dew Point Temp ≥ 0.5°C from previous hour, and Dew Point Temp < Ambient Temp for 12 consecutive hrs.	1/week or more frequent	G	Chapter 8, Table		
Solar Radiation	Hourly Recorded Solar Radiation	Night time SR = 0, Day time SR < max SR for date and latitude	1/week or more frequent	G	Chapter 8, Table		
Barometric Pressure	Hourly Recorded Barometric Pressure	BP < 1050 mb (sea level), BP > 945 mb (sea level), or Per site specific climatology criteria	1/week or more frequent	G	Chapter 8, Table		
Precipitation	Hourly Recorded Precipitation	Note: Develop site specific climatology criteria for each season	1/week or more frequent	G	Chapter 8, Table		
	Maintenance						
WS/VWS	Sensor bearings	Replace	1/6 months	G			
WD/VWD	Sensor Bearings	Replace	1/6 months	G			
SR		Per manufacturer's recommendations	Per manufacturer's recommendations	G			
DAS	Data Acquisition System (internal battery back-up)	Check Battery Back-up, Replace as needed	1/6 months	G			
	Bias/Accuracy						
WS, VWS	Performance Audit	5 points including zero, 2 m/s and 3 additional evenly spaced upscale points covering expected wind speeds for the site Audit points ≤ ± (2 m/s + 5% of observed) WS bearing torque threshold ≤ PSD quality sensor's manufacturer's specs		G	Chapter 5	QA Handbook Vol IV Section 2.7	Section 7 MQO Table A8

OPERATIONAL EVALUATIONS TABLE – METEOROLOGICAL MEASUREMENT METHODS

S - single instrument hourly value, G - group of hourly values from 1 instrument

Parameter	Criteria	Acceptance Range	Frequency	Samples Impacted	EPA -454/R-99-005 Feb 2000	EPA Regulation & Guidance	ADEC AM&QA QAPP
WS/WD (Sonic Anemometer)	Performance Audit	Collocated for min 72 hrs with on-site calibrated cup/vane or aerovane anemometer CTS WS criteria <ul style="list-style-type: none"> • $\leq \pm 0.2$ m/s + 5% observed CTS • SD of differences $\leq \pm 0.2$ m/s • Qualifications WS > 1 m/s WD criteria <ul style="list-style-type: none"> • $\leq \pm 5^\circ$ observed CTS • SD of differences $\leq \pm 2^\circ$ • Qualifications WS > 1 m/s 	NCore/SLAMS 1/year SPM 1/yr (suggested) PSD Every sensor Within 30 days of start-up and			QA Handbook Vol IV Section 2.7.3.2 CTS Method	
WD, VWD	Performance Audit	Alignment to True North + linearity audit points at: 0°, 45°, 90°, 135°, 180°, 225°, 270°, 315°, 360° Alignment $\leq \pm 5^\circ$ Linearity (All Points) $\leq \pm 3^\circ$ (included in $\leq \pm 5^\circ$ above) WD bearing torque threshold \leq PSD quality sensor's manufacturer's specs	1/6 months thereafter	G	Chapter 5 Chapter 8	QA Handbook Vol IV Section 2.7	MQO Table, Table A8 Section 16
Vector Data/DAS (WS, WD, $\sigma\theta$, σ_w)	Performance Audit	WS, $\sigma_w \leq \pm 0.2$ m/s WD $\leq \pm 5^\circ$		G		QA Handbook Vol IV Section 2.8	
Temp	Performance Audit	Minimum 3 point audit representative of min avg low to max avg high temps for the location. (e.g., -30°C, 0°C, +30°C) Each point $\leq \pm 0.5^\circ\text{C}$ of NIST Traceable Standard		G	Chapter 5 Chapter 8	QA Handbook Vol IV Section 3.6	MQO Table, Table A8 Section 16

|

This page intentionally left blank

TECHNICAL REPORT DATA

(Please read Instructions on reverse before completing)

1. REPORT NO. <i>EPA-454/B-08-002</i>	2.	3. RECIPIENT'S ACCESSION NO.
4. TITLE AND SUBTITLE Quality Assurance Handbook for Air Pollution Measurement Systems Volume IV: Meteorological Measurements		5. REPORT DATE : January, 2007
7. AUTHOR(S) Dennis Mikel, et. al..		6. PERFORMING ORGANIZATION CODE
9. PERFORMING ORGANIZATION NAME AND ADDRESS Office of Air Quality Planning and Standards U.S. Environmental Protection Agency Research Triangle Park, NC 27711		8. PERFORMING ORGANIZATION REPORT NO.
12. SPONSORING AGENCY NAME AND ADDRESS Office of Air Quality Planning and Standards U.S. Environmental Protection Agency Research Triangle Park, NC 27711		10. PROGRAM ELEMENT NO.
15. SUPPLEMENTARY NOTES		11. CONTRACT/GRANT NO.
16. ABSTRACT This is the fourth volume of the EPA's Quality Assurance Handbooks that describes meteorological instruments and systems. This Handbook describes the different types of instruments that are currently available. The Handbook discusses how to install, calibrate, audit and operate the different systems. The latter part of the document explains the process for validation and verification of meteorological data.		13. TYPE OF REPORT AND PERIOD COVERED
17. KEY WORDS AND DOCUMENT ANALYSIS		14. SPONSORING AGENCY CODE <i>EPA/200/04</i>
a. DESCRIPTORS	b. IDENTIFIERS/OPEN ENDED TERMS	c. COSATI Field/Group
Quality Assurance Handbook Meteorological Measurements Ambient Air Monitoring	Air Pollution control	
18. DISTRIBUTION STATEMENT Release Unlimited	19. SECURITY CLASS (<i>Report</i>) Unclassified	21. NO. OF PAGES 191
	20. SECURITY CLASS (<i>Page</i>) Unclassified	22. PRICE

