



# Measuring Coastal Acidification Using *In Situ* Sensors in the National Estuary Program

2021

EPA-842-R-21001

U.S. Environmental Protection Agency. 2021. Measuring Coastal Acidification Using *In Situ* Sensors in the National Estuary Program. Washington D.C., Document No. EPA-842-R-21001.

Note: All photos credited to the National Estuary Programs identified in this report, unless otherwise noted.



## **Co-Authors:**

### **Holly Galavotti, U.S. EPA Office of Water**

#### **Barnegat Bay**

Jim Vasslides, Senior Program Scientist, Barnegat Bay Partnership  
Matthew Poach, NOAA NMFS Milford Laboratory

#### **Casco Bay**

Curtis Bohlen, Director, Casco Bay Estuary Partnership  
Christopher W. Hunt, University of New Hampshire  
Matthew Liebman, U.S. EPA Region 1

#### **Coastal Bend Bays**

Xinping Hu, Harte Research Institute for Gulf of Mexico Studies, Texas A&M University–Corpus Christi  
Melissa McCutcheon, Ph.D. Candidate, Harte Research Institute for Gulf of Mexico Studies, Texas A&M University–Corpus Christi

#### **Long Island Sound Study**

Jim Ammerman, Long Island Sound Study Science Coordinator  
Jim O'Donnell, University of Connecticut  
Kay Howard-Strobel, University of Connecticut

#### **Massachusetts Bays (MassBays)**

Prassede Vella, Staff Scientist, Massachusetts Bay National Estuary Partnership

#### **Mobile Bay**

John Lehrter, University of South Alabama and Dauphin Island Sea Lab

#### **San Francisco Bay**

Karina Nielsen, San Francisco State University, Estuary & Ocean Science Center  
John Largier, University of California Davis, Coastal and Marine Sciences Institute

#### **Santa Monica Bay**

Tom Ford, Santa Monica Bay National Estuary Program  
Alex Steele, Los Angeles County Sanitation District (Retired)

#### **Tampa Bay**

Kimberly K. Yates, U.S. Geological Survey, St. Petersburg Coastal and Marine Science Center

#### **Tillamook Bay Estuary**

York Johnson, Water Quality Coordinator, Tillamook Estuaries Partnership  
Cheryl Brown, U.S. EPA ORD, Pacific Ecological Systems Division  
Stephen R. Pacella, U.S. EPA ORD, Pacific Ecological Systems Division

#### **Reviewers:**

Grace Robiou, U.S. EPA Office of Water  
Nicholas Rosenau, U.S. EPA Office of Water  
Bridget Cotti-Raush, 2019 Knauss Fellow  
Nancy Laurson, U.S. EPA Office of Water  
Alice Mayo, U.S. EPA Office of Water (retired)  
Vince Bacalan, U.S. EPA Office of Water  
Bill Fisher, U.S. EPA Office of Research and Development  
Rochelle Labiosa, U.S. EPA Region 10  
Patti Meeks, U.S. EPA Office of Research and Development

*Any mention of trade names, products, or services does not imply an endorsement by the U.S. Government or EPA. EPA does not endorse any commercial products, services, or enterprises.*

*The views expressed in this report are those of the authors and do not necessarily represent the views or policies of the U.S. Environmental Protection Agency.*

# Table of Contents

---

<b>Executive Summary .....</b>	<b>1</b>
<b>Background on Coastal Acidification and its Impacts .....</b>	<b>4</b>
1.1 Description of Ocean and Coastal Acidification .....	4
1.2 The Vulnerability of Nearshore and Estuarine Waters to Acidification .....	5
1.3 A New Approach to Monitoring Coastal Acidification at National Estuary Program sites .....	6
<b>Estuary Characteristics, Monitoring Goals and Timeline.....</b>	<b>9</b>
2.1 Estuary Characteristics.....	9
2.2 Goals of Monitoring.....	9
2.3 Monitoring Timeline.....	12
<b>Monitoring Methods .....</b>	<b>13</b>
3.1 Water Chemistry Sensors ( $p\text{CO}_2$ , pH).....	13
3.2 Telemetry.....	15
3.3 Deployment Locations .....	15
3.4 Discrete Sampling.....	27
3.5 Data Collection, Processing and Storage Methods.....	30
3.6 Cost Information and Funding Sources .....	34
<b>Deployment and Data Management Challenges and Lessons Learned.....</b>	<b>36</b>
4.1 Deployment Challenges and Lessons Learned .....	36
4.2 Data Management Challenges and Lessons Learned .....	43
4.3 Data Interpretation Challenges and Lessons Learned .....	44
4.4 Data Quality Challenges and Lessons Learned .....	45
<b>Monitoring Partnerships and Public Outreach .....</b>	<b>46</b>
5.1 National Estuary Program Monitoring Partnerships.....	46
5.2 Partnership Challenges and Lessons Learned .....	48
5.3 Public Outreach Efforts .....	50
<b>Preliminary Monitoring Results.....</b>	<b>52</b>
<b>Next Steps .....</b>	<b>67</b>
<b>References .....</b>	<b>71</b>

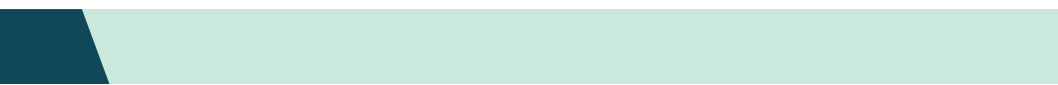

# Executive Summary

---

Estuaries and coastal areas are highly vulnerable to the impacts of acidification on shellfish, coral reefs, fisheries, and the commercial and recreational industries that they support. Yet, little is known about the extent of this vulnerability and the estuary-specific drivers that contribute to acidification, such as nutrient enrichment from stormwater, agriculture and wastewater discharges, upwelling of CO<sub>2</sub>-rich seawater, elevated atmospheric CO<sub>2</sub> from urban and agricultural activities, benthic and marsh-driven processes, and alkalinity and carbon content of freshwater flows. Comprehensive, high resolution monitoring data are needed at varying spatial and temporal scales to provide actionable information tailored to each estuary. Because carbonate chemistry in the coastal environment can be affected by nutrient dynamics, understanding how nutrient inputs exacerbate acidification impacts is essential for the formulation of estuary-specific actions.

EPA supports coastal acidification monitoring and research in various ways (Table 1). The purpose of this report is to share EPA's approach to long-term coastal acidification monitoring in which it initiated the use of autonomous monitoring sensors for dissolved carbon dioxide (*p*CO<sub>2</sub>) and pH deployed *in situ* in estuaries

across the country through EPA's National Estuary Programs (NEP) and their partners. This approach captures the high-resolution data that are needed to understand variability associated with acidification and ultimately to inform trends and mitigation and adaptation strategies for these vulnerable systems. This report details the plans and experiences of ten NEPs geographically distributed around the U.S. coast and their partners in conducting this monitoring over the last four years (2015–2019). The report illustrates the monitoring goals, deployment methods, data analysis, costs, preliminary results, and the role of partnerships in their successes. The preliminary results have already improved our understanding of baseline carbonate chemistry conditions in these estuaries, the factors affecting spatial and temporal variability, and the drivers responsible for changes in *p*CO<sub>2</sub> and associated acidification. The sensors are successfully capturing seasonal variability and finer temporal trends that provide information on diel variability, physical processes (e.g., weather, tides), and biological activity which cannot be captured with discrete sampling alone. The preliminary data indicate that there are regional differences in the drivers of acidification, particularly the



influence of upwelling events vs. land-based freshwater sources. Several of these NEPs have calculated aragonite saturation state, an indicator of conditions in which mollusk shells begin to dissolve and have identified certain vulnerable conditions for shellfish and other economically-important species in their estuaries.

Important lessons have been learned from these deployments. Biofouling, which inhibits effective sensor operation, was a significant challenge. Other challenges were difficult weather conditions, such as winter icing and hurricanes, and red tides that prohibit dive operations. These situations result in the temporary cessation of the sensor deployments and consequently data gaps. Two NEPs avoided biofouling and inhospitable environmental conditions by deploying the instruments in weatherproof coolers with flow-through systems. The ability to incorporate telemetry to transmit real-time data was seen as a very valuable asset to signal equipment failure or other reasons for a lapse in data collection. To address several of the challenges, these NEPs recommended purchasing redundant sensors to minimize any gaps in data collection but found it to be cost-prohibitive. They also stressed the importance of collecting *in situ* data for associated parameters so that acidification can be interpreted in the context of inshore processes, such as system hydrodynamics, mixing, and primary production. This EPA report provides additional insights on the challenges, lessons learned, and unique solutions regarding the use of these autonomous sensors in diverse estuarine environments.

EPA believes that sharing the methodologies and lessons learned in this report will lead to information sharing and technology transfer that will benefit the NEP community and other coastal monitoring groups, such as NOAA's 29 National Estuarine Research Reserves. In addition, this report provides useful information to a wide variety of stakeholders - from state legislators to shellfish growers to concerned citizens - who are interested in advancing the understanding of acidification drivers in order to protect their vulnerable estuaries from the impacts of acidification. The NEPs identified in this report have already begun integrating their monitoring results into actionable plans, such as their long-term Comprehensive Conservation and Management Plans (CCMPs) and State of the Bay reports, to inform stakeholders and identify ways to address coastal acidification vulnerabilities.

Over the long term, as these NEPs and other groups continue this monitoring, the monitoring data will help further characterize the vulnerability of these estuaries to acidification, detect potential impacts of acidification on locally important industries, and quantify the relative contribution of specific pollution sources. The state of the science of long-term coastal acidification monitoring, including advancement of *in situ* autonomous pH and  $p\text{CO}_2$  sensors, is rapidly evolving. The monitoring community is encouraged to continue to share results and lessons learned to inform applications of these data to guide mitigation and adaptation strategies.

**Table 1. EPA’s Coastal Acidification Activities**

ACTIVITY	DESCRIPTION
Inter-Agency Working Group on Ocean Acidification	EPA is an active member of the <a href="#">Inter-Agency Working Group on Ocean Acidification</a> (IAG-OA) which develops and updates the Strategic Plan for Federal Research and Monitoring of Ocean Acidification, provides Reports to Congress, and conducts other activities. The IAG-OA also spearheaded the creation of the <a href="#">Ocean Acidification Information Exchange</a> in collaboration with the Northeastern Regional Association for Coastal Ocean Observing Systems (NERACOOS) to share resources, access up-to-date information, and interact across disciplines and regions.
NEP Coastal Acidification Monitoring	<p>In 2015 and 2016, EPA began funding coastal acidification monitoring equipment for several NEPs and their partners identified in this report.</p> <p>In 2018, EPA published <a href="#">Guidelines for Measuring Changes in Seawater pH and Associated Carbonate Chemistry in Coastal Environments of the Eastern United States</a> (Pimenta and Gear, 2018).</p> <p>EPA Region 1 (New England) increased the technical capacity of citizen scientists monitoring coastal acidification in the Northeast by supporting <a href="#">Shell Day</a> (2019).</p> <p>EPA funded the <i>Ocean to Plate to Ocean</i> pilot study in Casco Bay that tests the impact of shell material deposition on pH and shellfish recruitment in tidal flats and demonstrates the feasibility and value of a shell collection program in Maine.</p>
EPA’s National Coastal Condition Assessment (NCCA)	EPA added total alkalinity as a research parameter to the 2020 survey. These measurements will provide a baseline understanding for coastal acidification buffering capacity against the drivers of coastal acidification for 750 sites across the contiguous U.S. and will improve models for predicting alkalinity from salinity in under-sampled areas.
EPA’s Office of Research and Development (ORD) Coastal Acidification Research	ORD’s Narragansett, RI Laboratory Research Facility and Pacific Ecological Systems Division in Newport, OR conduct monitoring and research on the ecological impacts of coastal acidification. Research is also being conducted to attribute coastal water quality impacts to local and global acidification drivers.

# Background on Coastal Acidification and Its Impacts

## 1.1

### Description of Ocean and Coastal Acidification

The ocean is currently experiencing rapid rates of acidification and carbonate ion reduction, which may exceed changes of the past 300 million years (Hönisch et al., 2012). Globally, one-third of anthropogenic  $\text{CO}_2$  released into the atmosphere is being absorbed by the ocean every year (NRC, 2010). When  $\text{CO}_2$  dissolves in seawater, it lowers the pH and reduces the availability of carbonate ions, impairing the ability of marine organisms to form calcified shells or skeletons and impacting other fundamental physiological processes such as respiration, photosynthesis, and reproduction. These impacts alter food webs and negatively affect economies dependent on services ranging from coral reef tourism to shellfish harvesting and fisheries.

Since preindustrial times, the average ocean surface water pH has fallen by approximately 0.1 units (30%) globally, from approximately 8.21 to 8.10 (Royal Society, 2005). However, pH could decrease a further 0.3-0.4 pH units globally by 2100 if atmospheric  $\text{CO}_2$  concentrations reach 800 ppm (Orr et al, 2005). Biological effects of acidification are occurring now and could become more severe. For example, pteropods, a pelagic sea snail that is an important prey species for fish such as salmon, cod, and mackerel, are especially vulnerable to corrosive conditions. Mass mortality events in shellfish hatcheries have also been linked to ocean acidification. Coral reefs, which provide trillions of dollars in societal services worldwide, are projected to experience decreased net calcification, a process necessary to maintain ecosystem function (Bushinsky et al, 2019).

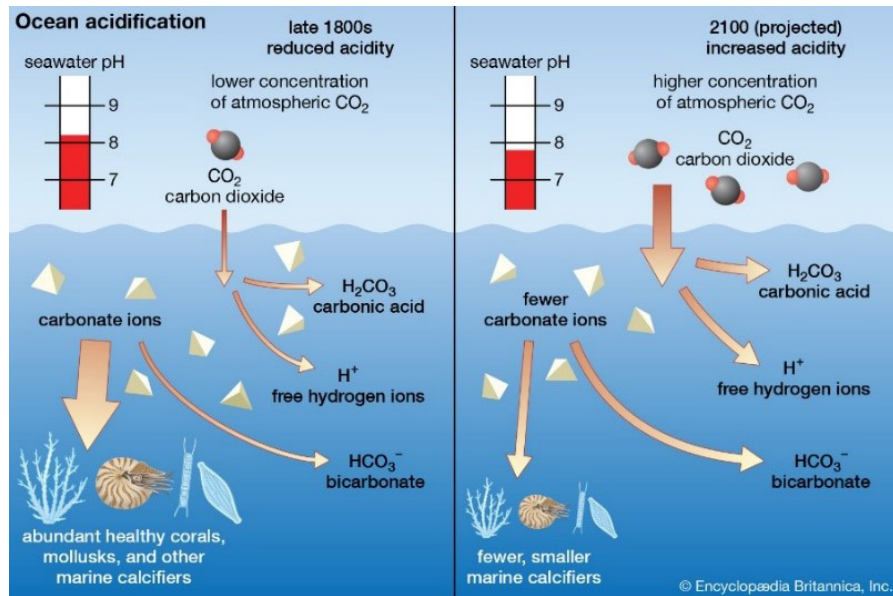

Conceptual diagram comparing the state of carbonates in the oceans under the lower-acid conditions of the late 1800s with the higher-acid conditions expected for the year 2100. Image: Encyclopædia Britannica, Inc.



## 1.2

### The Vulnerability of Nearshore and Estuarine Waters to Acidification

In estuarine and coastal areas, the causes, magnitudes, and rates of acidification differ in complexity as compared to the open ocean due to many natural and anthropogenic processes. In the coastal environment, in addition to atmospheric  $\text{CO}_2$  inputs, acidification could be locally amplified by a complex array of factors, including: the alkalinity and carbon content of freshwater flows; direct acid deposition; elevated atmospheric  $\text{CO}_2$  from urban and agricultural activities (Northcott et al, 2019); and changes in coastal circulation and upwelling of  $\text{CO}_2$ -rich seawater from the ocean. In particular, direct nutrient enrichment from stormwater, agriculture and wastewater discharges can contribute to coastal acidification. Excess nutrients fuel algae and phytoplankton growth. As the phytoplankton die

and decay,  $\text{CO}_2$  is respired by microbes and the gas is dissolved into seawater. As a result, local and regional “hot spots” of increases in  $p\text{CO}_2$  and declines in pH in coastal areas can occur, which are likely to be magnified when combined with other stressors in coastal ocean (Kelly et al, 2011). In addition, many coastal organisms have sensitive estuarine and nearshore life stages that coincide with mid and late summer extremes in dissolved oxygen, pH, and other characteristics of the carbon system and are thus expected to be especially vulnerable (Wallace et al, 2014). These complex biochemical dynamics need further study to better understand the relative contribution of these drivers to help coastal communities mitigate or adapt to coastal acidification.

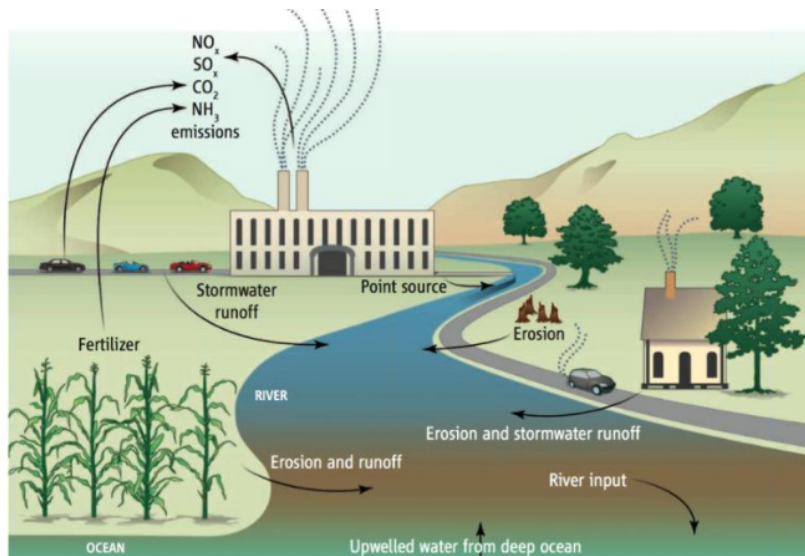

Kelly et al. 2011

## 1.3

### A New Approach to Monitoring Coastal Acidification at NEP sites

On the national scale, several agencies conduct ocean acidification monitoring. For example, NOAA's Ocean Acidification Monitoring Program's monitoring network includes repeat hydrographic surveys, ship-based surface observations, and time series stations (mooring and ship-based) in the open ocean waters of the Atlantic, Pacific and Arctic, and the Gulf of Mexico. The development of new long-term monitoring systems is critical for filling the existing knowledge gaps and advancing the current technology, especially in highly vulnerable areas such as high-latitude regions, upwelling regions, warm and cold-water coral reefs, and in coastal regions and estuaries where less is understood about the temporal and spatial variability of acidification.

The carbonate chemistry of estuaries is controlled by multiple co-occurring chemical, biological, and physical processes operating at various rates (from sub-hourly to inter-annual time scales). Because coastal environments have greater pH variability than the open ocean, the ability to detect real trends in coastal acidification and distinguish these from background variability requires high-quality, long term, high resolution monitoring. In addition, continuous monitoring of multiple parameters at a high temporal and spatial scale is vital in order to distinguish the relative influence of the drivers of coastal acidification, particularly nutrient-enhanced acidification. There are a small number of sites capturing long-term, decadal, coastal pH data useful for understanding short-term and spatial variation in coastal acidification, including NOAA's National Estuarine Research Reserves. However, the tools and approaches that are used are not consistent with those needed to detect climate scale trends and changes associated with anthropogenic changes in atmospheric CO<sub>2</sub>. The use of autonomous pCO<sub>2</sub> and pH sensors for high-resolution monitoring in the estuarine environment is a new, innovative approach that will complement the existing long-term pH measurements to provide climate level measurements. These types of autonomous sensors

have been used extensively in the open ocean to monitor ocean acidification, however, their deployment *in situ* in nearshore and estuarine waters is new and challenging due to rapid variation over large ranges in salinity and chemical composition, accuracy issues such as biofouling and sensor drift, and other factors (Sastri et al., 2019). In 2018, EPA published "Guidelines for Measuring Changes in Seawater pH and Associated Carbonate Chemistry in Coastal Environments of the Eastern United States" which includes a discussion of these autonomous sensors (Pimenta and Gear, 2018). Typically, as part of quality control, in addition to *in situ* measurement of pCO<sub>2</sub> and pH, discrete water samples are collected by the monitoring programs to be analyzed in the laboratory for total alkalinity (TA) and dissolved inorganic carbon (DIC). Any two of the four parameters (pH, pCO<sub>2</sub>, DIC and TA) can be used to measure aragonite state. Currently, pH and pCO<sub>2</sub> are the two parameters that are routinely measured using deployed sensors, but extensive research is currently underway to develop the technology that will permit development of sensors to measure DIC (e.g. at Woods Hole Oceanographic Institution).

EPA and the National Estuary Program (NEP) play an important role in understanding the impact of coastal acidification on water quality and living marine resources. The NEP is a place-based program established by Section 320 of the Clean Water Act with the mission to protect and restore the water quality and ecological integrity of estuaries of national significance. The 28 NEPs are located in coastal watersheds along the Atlantic, Gulf, and Pacific coastlines, and in Puerto Rico. Each NEP focuses on the restoration of a study area that includes the estuary and a portion of the surrounding watershed. The NEPs are administered in a variety of institutional settings, including state and local agencies, universities and individual nonprofit organizations. Of the 28 NEPs, 19 have identified coastal acidification as an emerging threat to their coastal resources in their [Comprehensive Conservation and](#)

Management Plans (CCMPs, 2003-2019), which contain actions to address water quality and living resource challenges and priorities (Figure 1). The CCMPs are long-term plans developed through a unique, consensus-based approach, and implemented with a variety of local partners. Many of these NEPs highlight the need for more data to improve understanding of acidification trends, the causes of low pH in their study areas, and effects of acidification on living resources. They also describe the need for local monitoring and research to develop acidification adaptation and management strategies. For example, in estuaries in which more acidic conditions are driven by upwelling events, strategies could include alerts to shellfish hatcheries warning of highly acidic conditions and implementing aquaculture techniques to buffer hatchery systems. In estuaries where acidic conditions are driven by eutrophic conditions, nutrient management strategies ranging from source reduction to seagrass restoration can be used to reduce acidification in vulnerable areas. Several NEPs link acidification to their nutrient action plans as a potential outcome of nutrient enrichment. In addition, 13 of the 28 NEPs have referenced the issue of acidification in their State of the Bay reports and cite the need for more monitoring data to establish baselines and develop models to better understand long-term trends in their estuaries (Figure 1).

The NEPs have demonstrated their leadership on this issue by expanding the use of autonomous  $p\text{CO}_2$  and pH sensors deployed *in situ* in estuarine and nearshore environments. Beginning in 2015, EPA funded nine NEPs to purchase autonomous  $p\text{CO}_2$  and pH sensors to better characterize carbonate conditions and thus obtain a better understanding of coastal acidification in their respective estuaries (Figure 1). Mobile Bay also recently purchased these sensors to conduct this monitoring. EPA's Office of Research and Development (ORD) Pacific Ecological Systems Division is also conducting this monitoring in Tillamook Estuary. Over the past four years, monitoring at eight<sup>1</sup> of these ten NEPs has been conducted through the collection of sub-hourly data ( $p\text{CO}_2$  and pH) and optimization of monitoring methods and data analysis procedures. The monitoring at these ten NEPs are the subject of this report. The Puget Sound Partnership, primarily through the Washington Department of Ecology, also conducts coastal acidification monitoring using autonomous, *in situ* pH and  $p\text{CO}_2$  sensors and the regular collection of discrete water samples. Although this data is not included in this report, more information can be found here: <https://ecology.wa.gov/Water-Shorelines/Puget-Sound/Issues-problems/Acidification>.

---

<sup>1</sup> MassBays and Mobile Bay are developing their monitoring methods but have not yet deployed their sensors.

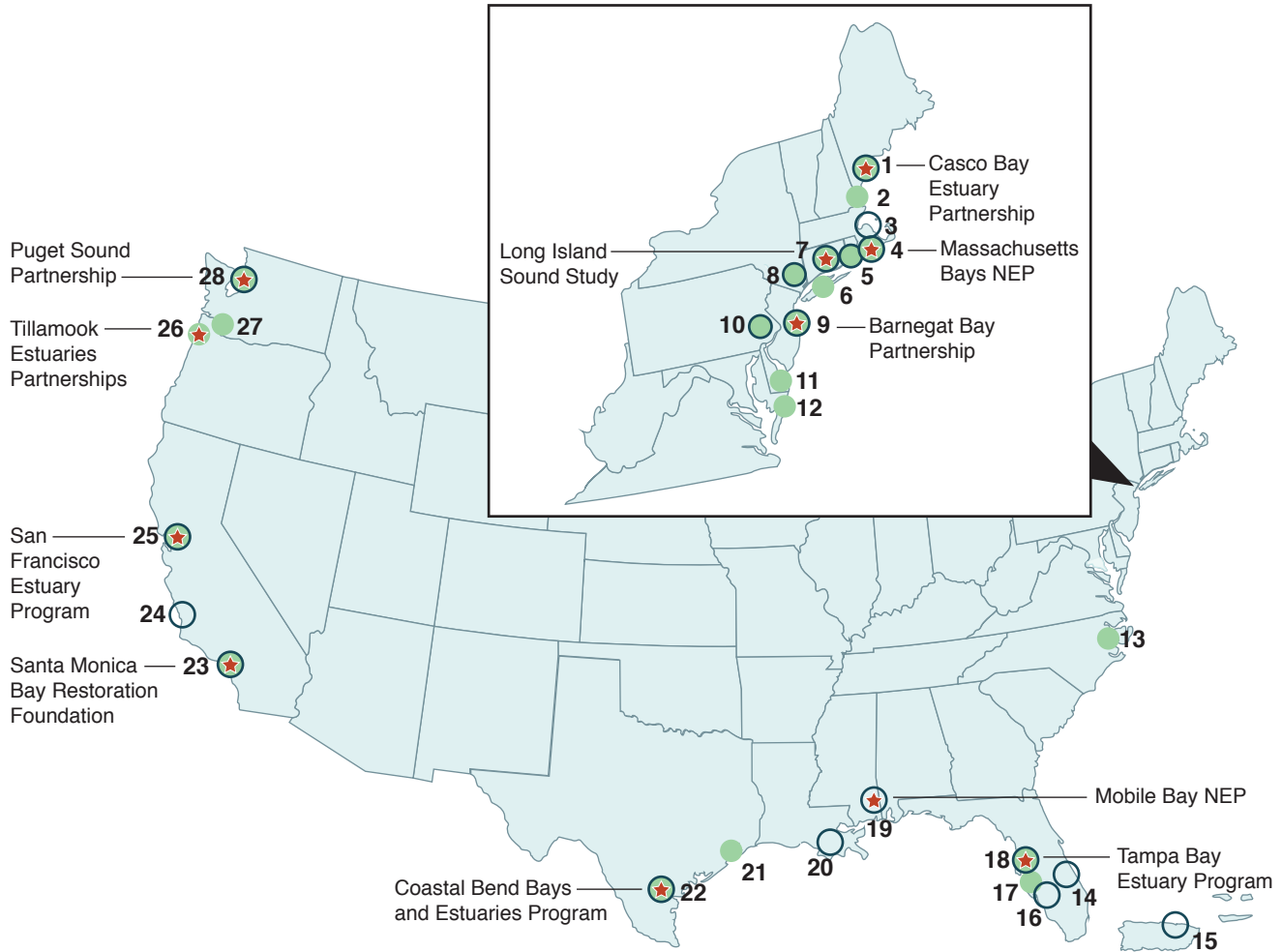

● NEP references acidification in latest State of the Bay report     
 ○ NEP addresses acidification in their CCMP     
 ★ NEP conducts acidification monitoring using autonomous pH and  $p\text{CO}_2$  sensors

- |  |   |  |
|--|---|--|
| 1 Casco Bay Estuary Partnership              | 10 Partnership for the Delaware Estuary | 21 Galveston Bay Estuary Program           |
| 2 Piscataqua Region Estuaries Partnership    | 11 Delaware Center for the Inland Bays  | 22 Coastal Bend Bays and Estuaries Program |
| 3 Buzzards Bay NEP                           | 12 Maryland Coastal Bays Program        | 23 Santa Monica Bay Restoration Foundation |
| 4 Massachusetts Bays NEP                     | 13 Albemarle-Pamlico NEP                | 24 Morro Bay NEP                           |
| 5 Narragansett Bay Estuary Program           | 14 Indian River Lagoon NEP              | 25 San Francisco Estuary Partnership       |
| 6 Peconic Estuary Partnership                | 15 San Juan Bay Estuary Program         | 26 Tillamook Estuaries Partnerships        |
| 7 Long Island Sound Study                    | 16 Coastal and Heartland NEP            | 27 Lower Columbia Estuary Partnership      |
| 8 New York-New Jersey Harbor Estuary Program | 17 Sarasota Bay Estuary Program         | 28 Puget Sound Partnership                 |
| 9 Barnegat Bay Partnership                   | 18 Tampa Bay Estuary Program            |  |
|  | 19 Mobile Bay NEP                       |  |
|  | 20 Barataria-Terrebonne NEP             |  |

Figure 1. National Estuary Programs Addressing Coastal Acidification

# Estuary Characteristics, Monitoring Goals and Timeline

---

## 2.1

### Estuary Characteristics

The ten NEPs, along with their partners, that are conducting coastal acidification monitoring using the continuous sensors include the following:

- **East Coast**
  - Casco Bay Estuary Partnership, ME
  - Massachusetts Bay National Estuary Partnership, MA (MassBays)
  - Long Island Sound Study, NY & CT
  - Barnegat Bay Partnership, NJ
- **Gulf of Mexico**
  - Tampa Bay Estuary Program, FL
  - Mobile Bay National Estuary Program, AL
  - Coastal Bend Bays and Estuaries Program, TX
- **West Coast**
  - San Francisco Bay Estuary Partnership, CA
  - Santa Monica Bay National Estuary Program, CA
  - EPA ORD/Tillamook Estuaries Partnership, OR

These ten NEPs vary in geographic location, size, environmental stressors, coastal dynamics and processes, and local economic interests. Santa Monica Bay is unique among these estuaries as the only deep, open coastal site as compared to the other more shallow, enclosed estuaries.

- Watershed Size: Small (663 mi<sup>2</sup>–Barnegat Bay) to large (12,580 mi<sup>2</sup>–Coastal Bend Bays)
- Land Use: Urbanized (Barnegat Bay) versus rural and agricultural (Tillamook Estuary)
- Watershed Population: 25,000 (Tillamook Estuary) to 9,000,000 (Long Island Sound)
- Estuary Depth: Shallow (Tillamook Estuary, San Francisco Bay) versus deep and open coast (Santa Monica Bay)
- Acidification Drivers: Freshwater inputs (Coastal Bend Bays) versus ocean upwelling (Santa Monica Bay)

## 2.2

### Goals of Monitoring

The ten NEPs share many of the same coastal acidification monitoring goals. These goals are centered on understanding the existing conditions of carbonate chemistry in the estuaries and how it is impacted by terrestrial and oceanic inputs.

#### Common Goals:

- Establish carbonate chemistry baseline data to determine background conditions.
- Better characterize the variability of carbonate conditions (daily, seasonal, and annual fluctuations) at a “continuous” time scale.
- Improve the understanding of land-based inputs (nutrient loading, freshwater flows) versus oceanic influence (upwelling) on the carbonate chemistry and oxygen dynamics.
- Determine how carbonate chemistry patterns are changing.
- Determine the effect of coastal acidification on plankton, shellfish and other species and the potential economic impacts to the bays and estuaries.
- Understand the relationship of alkalinity and salinity and inform our understanding of carbon dynamics.
- Build confidence in the performance of the sensors.

Based on their defining physical, hydrologic and living resource characteristics, these NEPs also have regional and estuary-specific monitoring goals, which are presented below.

#### East Coast Regional Goals:

The four NEPs in the East Coast are characterized by cool waters, with some coastal upwelling. Two of the NEPs (Casco Bay and MassBays) are characterized by large tidal influence, ranging up to 9-14 ft. These NEPs have numerous priorities, including protecting and restoring shellfish habitat. Their goals are to understand the impact of coastal acidification on shellfish resources/industry in the estuaries, as well as shellfish restoration and aquaculture efforts that are occurring in the area.

- **Casco Bay:** The Maine legislature created a bipartisan ocean acidification panel. They produced the report “Commission to Study the Effects of Coastal and Ocean Acidification on Commercially Harvested and Grown Species” and described acidification as a major stressor for lobster and clam fisheries in Maine and the importance of understanding calcification to protect the aquaculture industry. This monitoring will help understand the impact of coastal acidification on Maine’s shellfish resources and other living resources.
- **MassBays:** The overall objective is to identify coastal acidification conditions and to determine the potential impacts of acidification on aquaculture practices of the eastern oyster, *Crassostrea virginica* that would serve to inform the shellfish industry and other stakeholders. With the convening of the Massachusetts Ocean Acidification Commission (2018) by the Massachusetts legislature and the establishment of the Massachusetts Shellfish Initiative, this project will provide baseline information for informed decision-making.
- **Barneгат Bay:** The objective is to determine if coastal acidification is negatively impacting the shellfish restoration and aquaculture efforts that are happening in the area. Hard clams (*Mercenaria mercenaria*) are the subject of both wild harvest and aquaculture, while eastern oysters are an expanding aquaculture product in the estuary. Both clams and oysters are the focus of restoration efforts due to reduced wild populations compared to historic levels.
- **Long Island Sound:** Understand the why, how, and what controls the distribution of oxygen and the extent and duration of hypoxia within the Sound, which occurs annually in the summer and the potential overlap of acidification. They use buoys to observe daily fluctuations and long-term improvements in hypoxia due to reductions in nutrients.

- **Barneгат Bay:** Understand the interaction of multiple acidification enhancers in the Bay including eutrophication, localized seasonal coastal upwelling and extremely low pH freshwater sources.

### **Gulf of Mexico Regional Goals:**

The three NEPs in the Gulf of Mexico region are in a transition zone between warm-temperate and tropical biogeographic provinces, and are characterized by warm, productive waters. These NEPs described their goals as the following.

- **Tampa Bay:**
  - Assess the contribution of seagrass, mangrove forest and salt marsh habitats to sequestration of CO<sub>2</sub> as blue carbon, and the role of seagrass in protecting Tampa Bay’s marine species from harmful effects of climate change and coastal and ocean acidification.
  - Understand the seasonal and diurnal variations in carbonate chemistry in the bay, and the influence of Gulf of Mexico waters.
- **Mobile Bay:**
  - Understand trends and variability in carbonate chemistry related to river discharge and mixing with Gulf of Mexico waters.
  - Develop predictive models of acidification and hypoxia and impacts to economically important shellfish and finfish populations.
- **Coastal Bend Bays:** Examine the role of freshwater inflow from rivers on the recently observed trends in the carbonate system changes in Aransas Bay.

## West Coast Regional Goals:

The NEPs in the West Coast region are characterized as having cooler, deeper waters with prominent coastal upwelling. These NEPs described their goals as:

- **Santa Monica Bay:**

- Observe the impact of deep, colder water off the California coast on acidification and hypoxia. Capture the signal of upwelling events at 60m depth and determine whether the narrowness of the continental shelf plays a role.
- Establish a baseline dataset to assess and track ocean acidification and hypoxia in the Bay, which receives significant nutrient loading from anthropogenic activities.
- Develop expertise in operation and maintenance of the next generation of acidification monitoring sensors.
- Provide data for validation of model simulations, and to inform restoration efforts by Santa Monica Bay National Estuary Program.
- Provide final quality assurance (QA)/quality control (QC) data to the West Coast-wide California Current Acidification Network (C-CAN) that will be served publicly through the U.S. Integrated Ocean Observing System (IOOS) network.

- **San Francisco:**

- Enhance understanding of how climate change and watershed modifications and activities contribute to coastal acidification.
- Detect low-pH waters intruding from the ocean, especially during upwelling events in the spring and summer, in contrast to freshwater inflow events.
- Understand “natural cycles” within the Bay. Agricultural runoff leads to eutrophication, but the bay is not usually in a eutrophic state (no dense algal blooms).

- Understand the potential role of submerged aquatic vegetation (eelgrass and algal macrophytes) and wetlands in modifying carbonate chemistry of shallow water habitats.
- Understand the influence of coastal acidification on restoration and health of the native shellfish, the Olympia oyster and nursery habitat for Dungeness crab fishery.
- Understand the potential influence of coastal acidification on migrating salmonid and other endangered fish species in the estuary.

- **Tillamook Estuaries:**

- In 2017, the Oregon Senate created the Oregon Coordinating Council on Ocean Acidification and Hypoxia (OAH Council) to provide recommendations and guidance for the State on how to respond to this issue. The OAH Council developed a six-year Ocean Acidification & Hypoxia Plan in 2019 in recognition that acidification and hypoxia events are undermining the state’s rich ocean ecosystem food web. This monitoring will help to determine the role of watershed land use and eutrophication drivers versus coastal ocean conditions on occurrence of estuarine acidification and hypoxia.
- Identify sources of nutrients, bacteria, and organic material using stable isotopes and microbial source tracking upstream and downstream of areas with high human land use modification.
- Develop models to predict the impacts of climate change and watershed activities on water quality.

## 2.3

### Monitoring Timeline

Monitoring of coastal acidification by the NEPs identified in this report began on the East Coast in 2015 in Casco Bay and in many places continues today (Figure 2). Over the past four years, these NEPs have been collecting hourly and sub-hourly coastal acidification

data ( $p\text{CO}_2$  and pH). MassBays deployed and tested equipment in 2020 and Mobile Bay plans to deploy equipment in 2021. Coastal Bend Bays' research pier was destroyed in 2017 and the sensors could no longer be deployed.

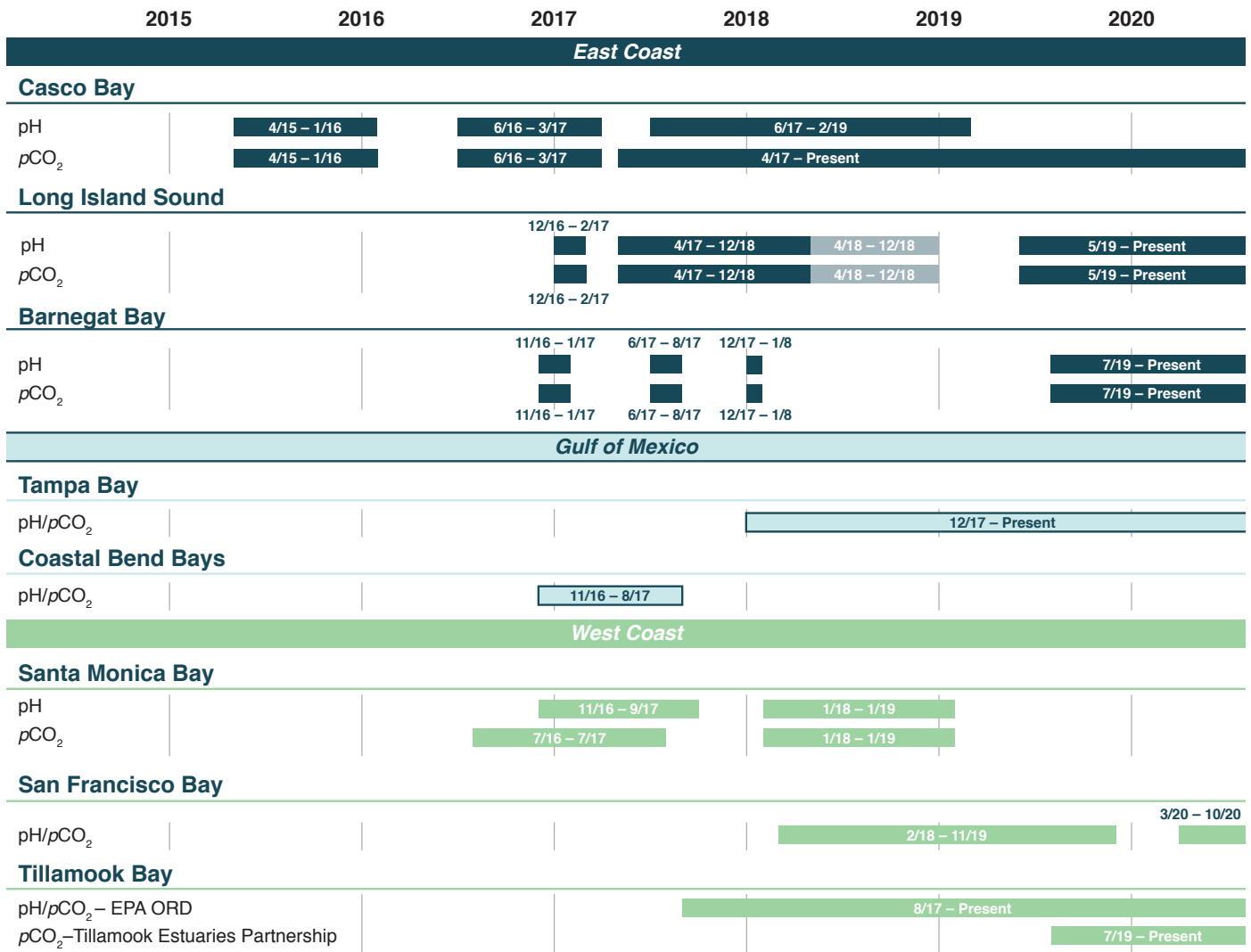

Figure 2. Timeline of pH and  $p\text{CO}_2$  Autonomous Sensor Deployments of eight NEPs.



# Monitoring Methods

## 3.1

### Water Chemistry Sensors ( $p\text{CO}_2$ , pH)

Two of the following four chemical parameters are needed to describe the seawater carbonate system –  $p\text{CO}_2$ , pH, dissolved inorganic carbon (DIC) and alkalinity – along with contemporaneous measures of temperature and salinity. To record pH and  $p\text{CO}_2$  data, autonomous sensors are being used in the ten NEPs (Table 2). Table 3 provides the specifications for these sensors including the accuracy, precision, resolution, and range. For measurement of pH, five of the NEPs use the SeaFET and five use the SeapHOX. The SeaFET pH sensor is an ion-sensitive field effect transistor (ISFET), which is shown to be more precise and stable over time and more durable compared to pH sensors that use a glass electrode. The pH range for the SeaFET is 6.5 to 9.0 pH. The SeapHOX integrates a SeaFET pH sensor with additional Seabird sensors that measure temperature, salinity, and dissolved oxygen (DO). The SeapHOX also includes an internal water pump and anti-fouling technology. Both the SeaFET and SeapHOX have internal battery power and data logging capabilities. MassBays' acidification system includes a Sunburst Sensors SAMI-pH, which measures pH using a colorimetric reagent method. The pH range for the SAMI-pH is 7 to 9. All pH data reported by the NEPs are on the "total" hydrogen ion concentration scale ( $\text{pH}_T$ ).

For measurement of  $p\text{CO}_2$ , six of the NEPs use the Sunburst Submersed Automated Monitoring Instrument (SAMI- $\text{CO}_2$ ) and the remaining NEPs use a Sunburst Shipboard Underway  $p\text{CO}_2$  Environmental Recorder (Super $\text{CO}_2$ ), Pro-Oceanus  $\text{CO}_2$ -Pro, or Moored Autonomous  $p\text{CO}_2$  (MAP $\text{CO}_2$ ). The Sunburst SAMI- $\text{CO}_2$  uses a colorimetric reagent method to measure the partial pressure of  $\text{CO}_2$  from 200 to 600  $\mu\text{atm}$ . The Sunburst Sensors SUPER- $\text{CO}_2$ , Pro-Oceanus  $\text{CO}_2$ -Pro, and Moored Autonomous  $p\text{CO}_2$  (MAP $\text{CO}_2$ ) all measure  $p\text{CO}_2$  using an infrared  $\text{CO}_2$  detector. However, the Sunburst Sensors SUPER- $\text{CO}_2$  is designed for shipboard analysis (not *in situ* deployment) and uses a Windows-based computer for analysis control and data collection and display.

Additional parameters allow for the analysis and identification of the drivers of estuarine carbonate

chemistry. All ten of the NEPs are collecting *in situ* measurements of temperature and salinity. Eight of the NEPs are also measuring DO, and six are collecting *in situ* chlorophyll *a* data (also measured as *in situ* fluorescence and photosynthetically active radiation (PAR)). One NEP, San Francisco Bay is also measuring atmospheric  $\text{CO}_2$ . These supporting data are measured using a variety of Seabird, YSI, Aanderaa and other instruments (Table 2).

The magnitude and timing of changes in temperature,  $p\text{CO}_2$  and pH allows for a determination of the diurnal and seasonal control. Salinity data provides information about the influence of tides and to distinguish between watershed and oceanic influences. Temperature data are used in conjunction with  $p\text{CO}_2$ , salinity, and pH data to assess, among other things, the timing and magnitude of oceanic upwelling and its associated effects on estuarine water chemistry. Dissolved oxygen paired with  $p\text{CO}_2$  can provide information about biological activity. Measurements of chlorophyll *a* and *in situ* fluorescence and photosynthetically active radiation (PAR) can provide an estimate of the abundance of phytoplankton which is an indicator of the eutrophic condition of the estuary which can inform an understanding of the impact of nutrient enrichment on the coastal carbonate chemistry. Turbidity provides information about the amount of suspended sediment in water which can block light to aquatic plants and carry pathogens. Coupling the monitoring information with runoff or other watershed data allows for assessment of oceanic versus watershed controls and may allow for greater insight into local versus regional drivers.

This monitoring data can also inform calculations of the aragonite saturation state of water. Aragonite saturation state is commonly used to track ocean and coastal acidification because it is a measure of carbonate ion concentration. As aragonite saturation state decreases, it is more difficult for organisms to build and maintain calcified structures. Calculating aragonite saturation requires that, in addition to temperature and salinity, at least two of the carbonate parameters ( $p\text{CO}_2$ , total alkalinity, DIC, pH) be known. However,  $p\text{CO}_2$  and

pH data from the sensors are not an ideal set of input parameters for calculating aragonite saturation (i.e. using the CO2SYS software package) because they carry the most uncertainty (Orr et al, 2018). Discrete samples analyzed for dissolved inorganic carbon (DIC) and/or alkalinity can be used in conjunction with pH and/

or  $p\text{CO}_2$  to calculate aragonite saturation states and act as validation data for the *in-situ* sensors, but many of these NEPs do not yet have the required discrete data available to make these calculations and therefore do not yet report time series of calcium carbonate saturation states.

**Table 2. Continuous Monitoring Sensors for pH and  $p\text{CO}_2$  and other parameters.**

NEP	pH SENSOR	$p\text{CO}_2$ SENSOR	OTHER SENSOR MEASUREMENTS <sup>1</sup>
Casco Bay	Sea-Bird SeaFET	Sunburst SAMI- $\text{CO}_2$	Aanderaa Oxygen Optode (DO) Seabird CTD (T, S, depth)
MassBays	Sunburst AFT pH	Sunburst SUPER- $\text{CO}_2$	Turner Designs Cyclops C7 (Turbidity, CDOM) Seabird SB45 (T, S) YSI (chlorophyll <i>a</i> , DO)
Long Island Sound	Sea-Bird SeaFET	Sunburst SAMI- $\text{CO}_2$	Sea-Bird Hydrocat EP X2 (DO) YSI (T, S, Turbidity, chlorophyll <i>a</i> )
Barnegat Bay	Sea-Bird SeaFET	Pro-Oceanus $\text{CO}_2$ Pro-CV	YSI Exo2 Sonde (T, S, DO, Turbidity)
Tampa Bay	Sea-Bird SeapHOx	Pro-Oceanus $\text{CO}_2$ -Pro	SeapHOx (T, S, DO) Wetlabs EcoPAR
Mobile Bay	Sea-Bird SeapHOx	Sunburst SAMI- $\text{CO}_2$	YSI (T, S, DO, chlorophyll <i>a</i> )
Coastal Bend Bays	Sea-Bird SeaFET	Sunburst SAMI- $\text{CO}_2$	YSI (T, S)
Santa Monica Bay	Sea-Bird SeapHOx	Sunburst SAMI- $\text{CO}_2$	Sea-Bird SeapHOx (T, S, DO)
San Francisco Estuary	Sea-Bird SeaFET (surface) Sea-Bird SeapHOx (deep)	Moored Autonomous $p\text{CO}_2$ (MAP $\text{CO}_2$ )	Sea-Bird SeaFET & CTD (T, S, DO, chlorophyll <i>a</i> ) Sea-Bird SeapHOX (T, S, DO)
Tillamook Estuary	Sea-Bird SeaFET & Sea-Bird SeapHOx	Sunburst SAMI- $\text{CO}_2$	YSI (T, S, DO, chlorophyll <i>a</i> )

<sup>1</sup> Temperature (T), Salinity (S), Dissolved oxygen (DO), Colored Dissolved Organic Matter (CDOM)

**Table 3. Sensor Specifications.**

INSTRUMENT	PARAMETER	ACCURACY	PRECISION	RESOLUTION	RANGE
SunBurst SAMI-CO <sub>2</sub>	pCO <sub>2</sub>	+/- 3 µatm	± 0.5–1 µatm		150–700 <sup>a</sup>
Pro-Oceanus CO <sub>2</sub> -Pro CV	pCO <sub>2</sub>	±0.5% of meas. val.	0.01 ppm		0–10,000
MAPCO <sub>2</sub> <sup>b</sup>	pCO <sub>2</sub>	+/- 2 µatm	0.7 ppm		0–800
Sea-Bird SeapHOx	pH	± 0.05		± 0.004	6.5–9
	DO	± 0.1 mg L <sup>-1</sup>		0.2 µmol kg <sup>-1</sup>	120% of surf. sat.
	Temp	± 0.002 °C <sup>c</sup> ± 0.01°C <sup>d</sup>		0.0001°C	–5 to 45 °C
Satlantic SeaFET	pH	± 0.02	± 0.004		6.5–9
Aanderaa Oxygen Optode	DO	<8 µM		<0.1 µM	0–1,000 µM

<sup>a</sup> Instrument can be calibrated for extended ranges

<sup>b</sup> LiCOR LI-820 CO<sub>2</sub> gas analyzer (Sutton et al., 2014)

<sup>c</sup> Temperature range: -5 to 35 °C

<sup>d</sup> Temperature range: 35 to 45 °C

## 3.2 Telemetry

Six of the ten NEPs have coastal acidification systems with wireless telemetry capability, which automatically transmits the sensor data via a cellular system to a land-based computer server that receives and stores the data. The advantage of a telemetry system is the real-time access to the data, which eliminates the need to retrieve the sensor and download data. Telemetry also allows the timely review of the data to identify potential sensor malfunctions or issues while they are still deployed. The use of data telemetry requires power to run both the data logger and the telemetry system. Solar panels and rechargeable batteries or landside electrical current can be used to power the data telemetry systems.

The four NEPs without telemetry (Casco Bay, Coastal Bend Bays, Santa Monica Bay, and Tillamook Estuary) are currently monitoring locations that lack the infrastructure necessary for cellular telemetry; however, some of these NEPs hope to incorporate telemetry into their systems in the future. Deployments without data telemetry are retrieved manually on a regular basis, and the data are downloaded directly from the sensors or data logger. Data download usually coincides with retrieval for sensor maintenance and service.

In 2015, Tampa Bay initiated a pilot study to examine the potential role of seagrass recovery in buffering Tampa Bay from ocean acidification. Discrete and autonomous water chemistry measurements were collected and used to calculate carbon speciation,  $p\text{CO}_2$ , and the saturation state of aragonite. The spatial and temporal heterogeneity and the water flow effects observed in Upper and Lower Tampa Bay informed the selection of the location and appropriate sampling times and constraints for the coastal acidification monitoring.

### 3.3

#### Deployment Locations

The deployment locations for the coastal acidification monitoring equipment vary from fixed, land-based structures (such as docks, piers, and pilings) to water-based buoys and moorings. The following factors were considered when determining on the location of the deployments:

- Accessibility of the site (legal access, secure location, accessible from shore or by boat).
- Availability of historic or present data monitoring efforts at that location, which may be used to augment the NEP's data collection effort or to hindcast past  $p\text{CO}_2$  levels using historically available data.
- Existing piers, moorings or buoys from which to deploy instrumentation. This can result in significant cost savings (**Long Island Sound, MassBays, Tampa Bay, Mobile Bay, Santa Monica Bay, Tillamook Estuary**).
- Presence of point source, non-point source, or deep-water upwelling inputs to study the influence of these sources on coastal acidification (**Tillamook Estuary**).

- Hydrodynamics within the estuary:
  - Freshwater versus ocean signals (**Tillamook Estuary**)
  - Capture bay-wide mixing in a major inter-island tidal channel between the inner and outer bay (**Casco Bay**)
  - Shallow water eutrophic versus deeper water aphotic contributions (**Santa Monica Bay, San Francisco Estuary**).



Buoy (Long Island Sound ARTG Buoy)

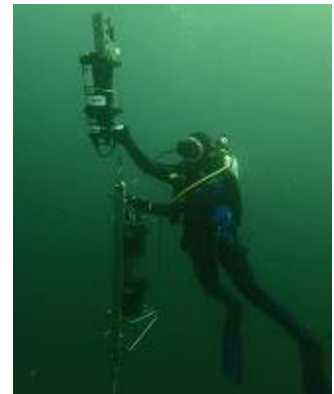

Mooring (Diver connects SeapHOx sensor to  $p\text{CO}_2$ )  
Credit: Sanitation Districts of Los Angeles County

- Presence of submerged aquatic vegetation, which may help mitigate acidification effects (**Tampa Bay, Tillamook Estuary**).
- Presence of resources that could be negatively impacted by acidification (shellfishing areas, aquaculture, or shellfish restoration areas) (**MassBays, Barnegat Bay, Mobile Bay, San Francisco Estuary, Tillamook Estuary**).



Cooler (Coastal Bend Bays)

## CASCO BAY ESTUARY PARTNERSHIP

The Casco Bay acidification instrument array is located at a pier at Southern Maine Community College in South Portland. The pier, which is over two-hundred feet long, is located in the Portland Channel, an important southern outlet of Casco Bay, and near outlets of the Fore and Presumpscot Rivers in a relatively urban area of Casco Bay. This location was selected because it is nearshore, accessible, and has historic nutrient data collected by the Friends of Casco Bay.

The sensors are housed in a cage that is attached via a davit within a secure box at the pier in about 1 to 5 meters of water (depending on tide). The cage rests on the bottom, and the sensors are about 0.5 meter off the bottom and always submerged. The metal frame with the instrument array is lowered through a trap door in the pier. A hoist system and crank are used to raise the frame up for servicing.

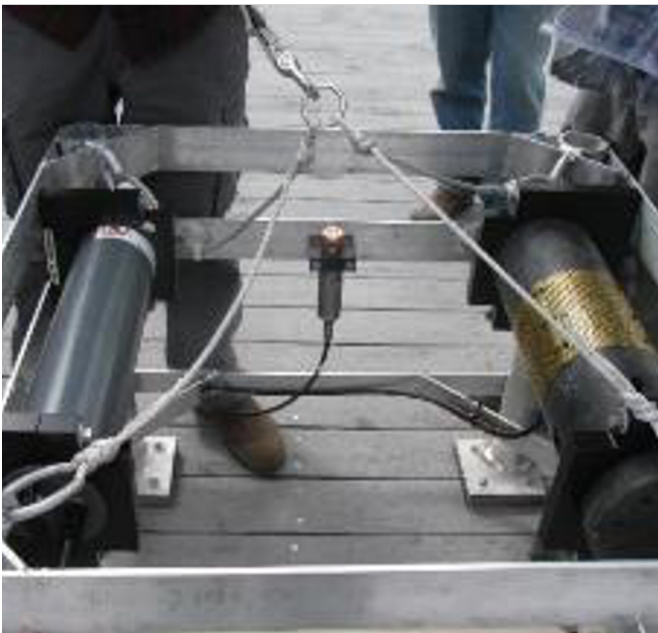

*Casco Bay instrument array*

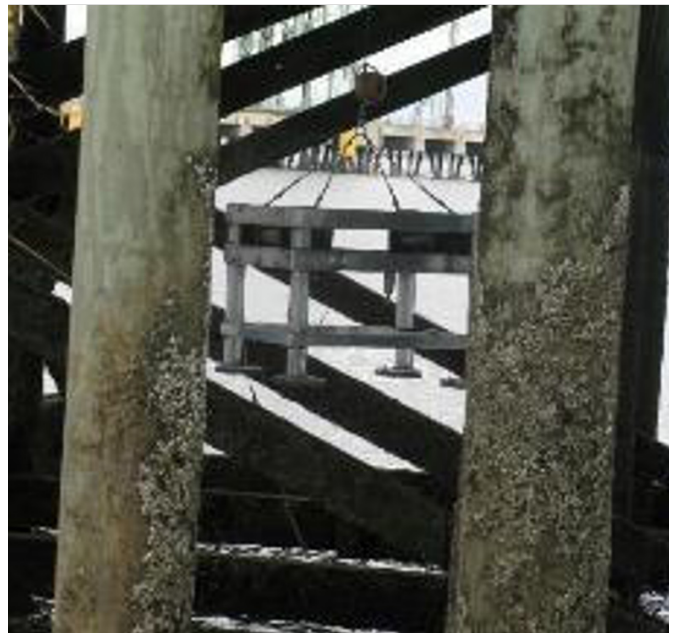

*Lowering instrument array through door in Southern Maine Community College pier, Portland Channel, ME*

## MASSBAYS

In spring 2020 MassBays deployed a flow-through pumped system that incorporates pH and  $p\text{CO}_2$ , temperature, salinity and CDOM. The system will be mounted on a fixed pier in Duxbury Harbor, an estuarine embayment where extensive oyster aquaculture takes place. Designed and constructed by the Center for Coastal Environmental Sensing Networks (CESN) at UMass Boston, the system is built specifically to collect data year-round as it will be minimally impacted by biofouling. Initial lab tests suggest  $p\text{CO}_2$  sensor is consistent with calibration gases. The sampling chamber has been modified to reduce interference from bubbles. The pumping system with mounting pole, float, and internal plumbing has been designed and constructed to minimize bubbles. The mounting pole was deployed experimentally in early 2019 and has survived the winter (with 7 days of below  $-12^\circ\text{C}$  temperatures) with minor warping resulting from sea ice.



MassBays' instrument array in cooler



Sensor deployment, town pier in Duxbury Bay, MA

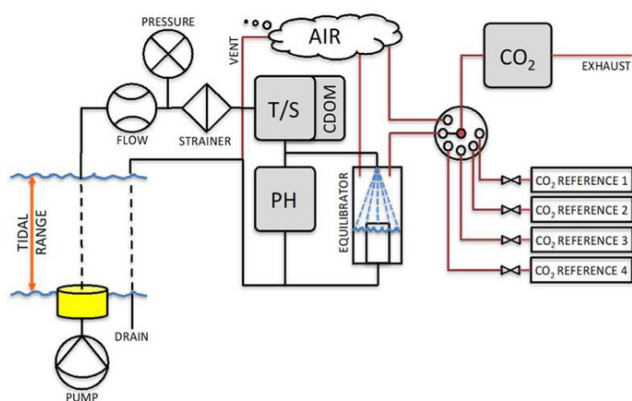

Schematic diagram of the system being deployed in Duxbury Harbor (CESN, UMass Boston)

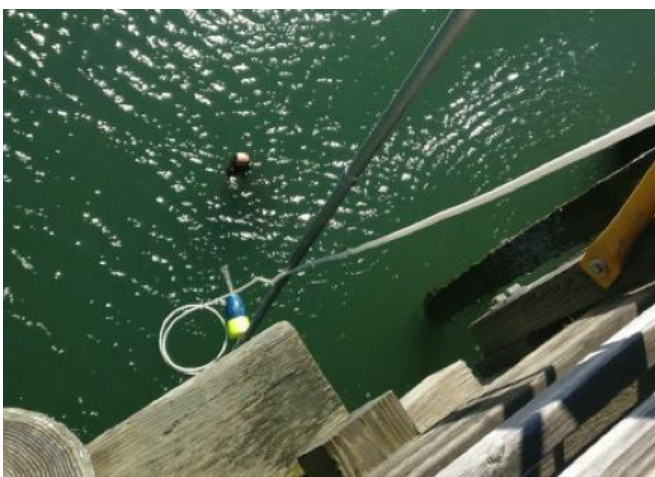

Mounting pole at Duxbury Harbor Town Pier for pumping seawater to the coastal acidification monitoring system

## LONG ISLAND SOUND

Long Island Sound is using an existing series of Long Island Sound Integrated Coastal Observing System (LISICOS) buoys to measure coastal acidification. The buoy locations were chosen to observe daily fluctuations and the expectation to observe long-term improvement associated with nutrient reduction in the sound. The Western Long Island Sound (WLIS) buoy is the main buoy (south of Greenwich, Connecticut) and has  $p\text{CO}_2$  and pH sensors at the bottom depth (approximately 70 feet deep). The ARTG buoy, 13.6 nm east of the WLIS Buoy, is located at the edge of the hypoxia zone and has a pH sensor at the bottom depth (79 feet). If changes to hypoxia were to occur over time due to management practices, they would be observed first at the ARTG buoy. These buoys also collect DO, temperature, salinity, and current data. Sensors for meteorological (wind, air temperature, pressure) are also mounted to the buoys.

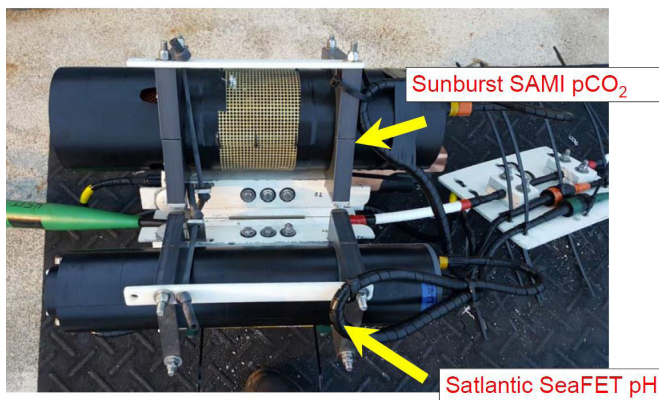

*Long Island Sound instrument array*



*WLIS buoy, south of Greenwich, CT*

## BARNEGAT BAY

Barnegat Bay maintains three continuous water quality monitoring stations in the Barnegat Bay-Little Egg Harbor estuary. The northern two stations have been operating for over 10 years, while the southernmost station was developed in 2016 specifically as a coastal acidification monitoring station. The BB-LEH estuary system experiences several local amplifiers for acidification, which makes it ideal for monitoring carbonate chemistry. There is an upwelling center off Little Egg Inlet, and Little Egg Harbor is also fed by low pH and alkalinity water. Upper Barnegat Bay, meanwhile, is highly eutrophic. Finally, there are a number of shellfish aquaculture and restoration projects ongoing throughout the watershed, in addition to the historic hard clam fishery.

The coastal acidification deployment is located on a piling at Morrison's Marina in Beach Haven, New Jersey. The deployment is powered by a rechargeable 12-volt battery and solar panel. In the original build, the three instruments were separated, with the SeaFET deployed vertically in its own tube, and the CO<sub>2</sub>Pro-CV mounted horizontally with the Sea-bird pump. After deploying it for some time with that layout and speaking with the technical staff at Satlantic and Pro-Oceanus, the devices were collocated together in a horizontal layout. The Seabird pump now pushes the water through the SeaFET and then the CO<sub>2</sub>Pro-CV. The YSI EXO2 data sonde is deployed in a vertical tube.



*Barnegat Bay instrument array*



*Piling with solar panel at Morrison's Marina, Beach Haven, NJ*



## TAMPA BAY

Tampa Bay currently has two deployments. The Tampa Bay Ocean Carbon System (OCSv2) is deployed in mid-water column (2.5 m depth) on an existing University of South Florida (USF) piling (Middle Tampa Bay Physical Oceanographic Real-Time System (PORTS) station), in collaboration with Dr. Mark Luther, USF. This system is powered by a solar panel with rechargeable battery. The USF station provides meteorological parameters and is also located near a National Oceanic and Atmospheric Administration (NOAA)/USF PORTS currents/tide station. This location provides pre-existing infrastructure for cost savings to the NEP and is within a mixing area of the bay, which will help determine the net impact of acidification on Tampa Bay.

A new array (OCSv3) was deployed in the Gulf of Mexico, 60 miles offshore from Tampa Bay, on October 25, 2018. The OCSv3 is a surface mount system on the existing USF Coastal Ocean Monitoring and Prediction System (COMPS) C12 buoy in collaboration with Dr. Robert Weisberg. The acidification sensors were integrated into the existing buoy using custom brackets and were programmed to measure and telemeter hourly data.



*OCSv2 on USF piling, Middle Tampa Bay station*



*OCSv3 buoy, 60 miles offshore, Gulf of Mexico*

## MOBILE BAY

The Mobile Bay instruments will be deployed in 2021 at the Middle Bay Lighthouse (30° 26.2 N, 88° 00.7 W) at a depth of approximately 4 m, which is about 1-m above the bottom. This site has been continuously monitored for T, S, and DO since 2005 as part of the Alabama Real-time Coastal Observing System (ARCOS), which is maintained by the Dauphin Island Sea Lab (<https://arcos.disl.org>). Waves and currents have also been monitored at this site since 2012. Geographically, the site is in the middle of the Bay and is broadly representative of the river influenced and highly productive Mobile Bay.

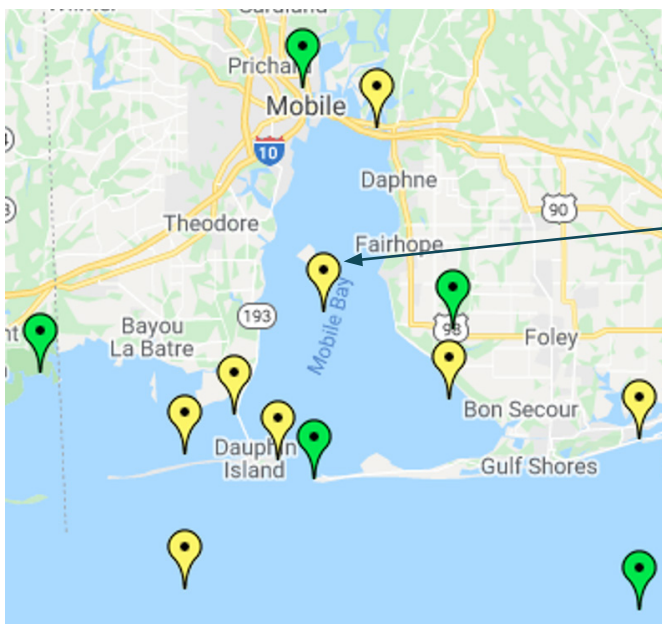

 : Operated by DISL.  : Operated by partners.

Alabama's Real-Time Coastal Observing System (ARCOS) stations



Middle Bay Light Station in the center of Mobile Bay

## COASTAL BEND BAYS

The Coastal Bend Bays deployment was located at the research pier of the University of Texas Marine Science Institute, in the Port Aransas Ship Channel. In 2017, the pier was destroyed by a post Hurricane Harvey accident. The ship channel (i.e., Aransas Pass tidal inlet), connects estuarine water with water in the northwestern Gulf of Mexico. The 300-ft pier had a 1200 ft<sup>2</sup> lab at its base and a 150 ft<sup>2</sup> instrument room on the end (Hu et al., 2018). The terminus of the pier and instrument room housed a weather station, tide gauge, current meter, and sensors for water temperature and salinity. Gauges and sensors were all located at approximately 5 m underwater. The Mission Aransas National Estuarine Research Reserve (MANERR) maintained the salinity and temperature sensors, and data were being recorded every 15 minutes. The SAMI-CO<sub>2</sub> and SeaFET pH sensors were housed inside a 100-quart cooler, with surface water pumped directly from the ship channel (at approximately 3 ft depth below the surface) into the cooler housing the sensors. Sensor measurements were made on the hour, after 20 minutes of pumping fresh seawater into the cooler prior to the measurement. The YSI sonde was deployed directly into the ship channel at 3 ft depth. Coastal Bend Bays hopes that the research pier will be rebuilt, and the sensors redeployed; however, they are also seeking to deploy at another site in productive waters.



*Coastal Bend Bays cooler system housing sensors*



*University of Texas Marine Science Institute Research pier, Port Aransas Ship Channel*

## SANTA MONICA BAY

Santa Monica Bay's instrument package consists of a Sunburst SAMI- $p\text{CO}_2$  and a Sea-Bird SeapHOx in a custom-built frame. During Year 1, the sensors were suspended at 50 ft below the water surface at an existing thermistor string mooring located offshore of Palos Verdes Point, where the water depth is approximately 75 ft. This location was chosen to characterize ocean acidification and hypoxia (OAH) in shallower water within the surface mixed layer, and within a few hundred meters of established kelp beds. The depth and location of the sensors were expected to minimize effects from point discharges to Santa Monica Bay. During the Year 2 deployment, the same sensor array was relocated on a new mooring further south near the outer edge of the Palos Verdes shelf, where the water depth is 230 ft. The sensors were deployed at a depth of 197 ft. The location for the second deployment was chosen to characterize the deeper water and to determine if the signals are different than those picked up during the deployment in shallower waters, particularly during strong upwelling events. Because both mooring locations were located near existing Sanitation Districts of Los Angeles County water quality stations quarterly CTD casts were collected for comparison.



*Santa Monica Bay instruments with custom cage*

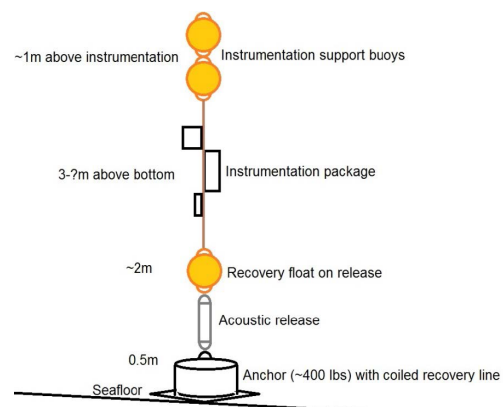

*Instrument deployment mooring diagram, deployed offshore of the Palos Verdes Point (Year 1) and the outer edge of the Palos Verdes shelf (Year 2)*

## SAN FRANCISCO ESTUARY

San Francisco Estuary has two deployments located in Central San Francisco Estuary, in the deep channel that runs close to shore on the eastern side of the Tiburon peninsula. The monitoring location is within a tidal excursion of the mouth of the bay, at the interface between Central Bay (outer embayment) and San Pablo Bay (North Bay). There is a high range of salinity at this location (at low tide, there is an estuarine water signal and at high tide there is an ocean water signal).

The first deployment is a surface deployment called the Bay Ocean Buoy (BOB), which consists of a MAPCO<sub>2</sub> buoy with conductivity, temperature, and depth (CTD) and SeaFET sensors. The second is a deep-water mooring at the 60 ft isobath with a SeapHOX located just above the bottom and is called the Marine Acidification Research Inquiry (MARI).



*San Francisco Estuary - BOB*



*MARI, deep-water mooring in Central Bay*

## TILLAMOOK ESTUARY

Tillamook's initial deployment by EPA ORD Pacific Ecological System Division is a fixed deployment at a dock at the Port of Garibaldi, which is a commercial fish offloading location. This location is near the mouth of the estuary as well as a wastewater treatment outfall. During periods of high river discharge, there is salinity stratification (and temperature to a lesser extent). The sensor array is mounted underneath the dock, which protects the equipment from floating debris and collisions with boats. The sensor array consists of one Satlantic SeaFET or SeapHOx pH sensor (swapped during periods of calibration/maintenance), one Sunburst SAMI-CO<sub>2</sub> sensor, and one YSI 6000 series or EXO sonde. The array is accessed by boat and a pulley system is used to raise the instruments for retrieval and maintenance. The instruments are deployed approximately 1 meter above the bottom, and at an average depth of 3.8 m.

Tillamook Estuaries Partnership expanded the project to include an additional station located adjacent to oyster operations in the middle of the Tillamook Bay. A SeaFET and YSI EXO data sonde are contained in PVC pipes mounted to a weighted 1 m by 1 m stainless steel basket. The basket is marked with a buoy and retrieved for equipment maintenance and exchange. The mooring holds the instruments 0.3 m above the bottom at an average depth of 2.5 m.

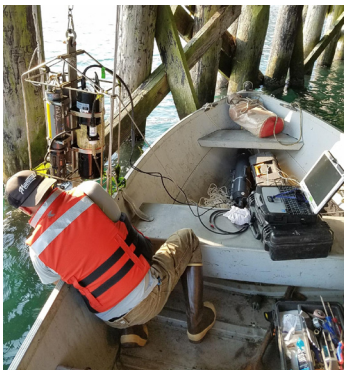

*Tillamook Estuary's instrument array*



*Location of dock at Port of Garibaldi and nearby site of outfall (Yellow dot – EPA ORD deployment site; Red dot – Tillamook Estuaries Partnership deployment site)*

## 3.4

### Discrete Sampling

In addition to the continuous, *in situ* sensor measurements, discrete water samples are collected by the ten NEPs to validate the sensor measurements and to provide additional analytical data necessary to characterize the water chemistry and to calculate aragonite and calcite saturation. These NEPs most often collect and analyze discrete samples for pH, dissolved inorganic carbon (DIC), and total alkalinity (TA). The frequency of discrete sample collection ranges from weekly to quarterly and is often timed to coincide with sensor cleaning, other maintenance, and downloading the data. Most of the discrete sample collection is conducted by these NEPs, their partner staff or academic researchers. MassBays plans to use trained citizen scientists to collect discrete samples on a biweekly basis. In addition, a YSI sonde will be used to measure turbidity, DO and chlorophyll a.

Some of these NEPs also use discrete or *in situ* measurements collected by other research programs to cross-calibrate their sensor data. For example, Santa Monica Bay uses conductivity, temperature and depth (CTD) profile data, collected quarterly by Los Angeles County Sanitation District (LACSD) at nearby stations,



*San Francisco Estuary Sampling Event*

to evaluate the comparability between those CTD measurements and the acidification mooring sensors. Long Island Sound cross-calibrates its temperature, salinity, pH, and DO measurements with Connecticut Department of Energy and Environmental Protection ship surveys, which complement Long Island Sound's acidification program.

A description of the discrete sampling programs for each of the ten NEPs conducting coastal acidification monitoring is provided below.

To be able to analyze discrete water samples and reduce turn-around time for sample results, US EPA ORD procured a carbonate chemistry analyzer built by Burke Hales at Oregon State University. The system measures  $p\text{CO}_2$  and DIC and can operate in both flow-through mode and be used to collect discrete samples. Discrete water samples from Tillamook Estuary are being analyzed using this instrumentation.

## DISCRETE SAMPLING

### CASCO BAY

Bottle samples are collected every four to six weeks for laboratory analyses for TA, DIC, and pH and used to back-calculate estimated pH and  $p\text{CO}_2$ , and aragonite and calcite saturation. Sample collection coincides with downloading the data and cleaning the sensors.

### MASSBAYS

A program of biweekly discrete samples will be conducted. Citizen scientists will be trained to collect the samples. The samples will be delivered to EPA's laboratory (Atlantic Coastal Environmental Sciences Division) in Narragansett, R.I. and analyzed for total alkalinity and DIC. The Center for Coastal Environmental Sensing Networks (CESN) at UMass Boston is currently collecting monthly discrete samples from Duxbury Harbor to collect background data. This initial preliminary survey demonstrated that salinity was relatively stable throughout the Harbor with little variation during a dry period. So far, no sampling has been conducted during a wet weather event to assess the variability due to freshwater inputs.

### LONG ISLAND SOUND

The Connecticut DEEP ship surveys complement the Long Island Sound acidification program, and the data are used for cross-calibration of temperature, salinity, pH, and DO. In addition, a CTD probe with a calibrated pH sensor is lowered into the water column near the buoy about once a week in the summer. Discrete samples were not collected in 2019.

### BARNEGAT BAY

Weekly discrete samples were collected for laboratory analysis of DIC (coulometer) and pH (spectrophotometer) during the 2017 sampling season. Unable to collect discrete samples during 2019.

### TAMPA BAY

Discrete samples are collected every 2 to 4 weeks at the Tampa Bay station and approximately quarterly at the offshore location. Samples are analyzed for pH, DIC, TA, and total nitrogen and phosphorus. Spectrophotometric pH is measured in the field.

### MOBILE BAY

Discrete samples will be collected monthly at Middle Bay Light and at approximately 10 other stations across the salinity gradient. Samples will be analyzed for carbonate system variables, as well as dissolved and particulate inorganic and organic nutrients, dissolved and particulate organic carbon, and phytoplankton biomass and production rates, and community respiration rates.



## DISCRETE SAMPLING

### COASTAL BEND BAYS

Discrete water samples have been collected since May 2014 through present. Biweekly to monthly field sampling at five System-Wide Monitoring Program (SWMP) sites, including the UTMSI research pier, located within the Mission Aransas National Estuarine Research. Discrete sampling has continued since the destruction of a pier where the sensor deployment was located. Eight or nine months of biweekly sampling and three months of monthly sampling have been conducted. Discrete samples are analyzed for DIC, pH, and TA.

Duplicate water samples at both the pump inlet depth using a Van Dorn sampling bottle and inside the cooler where the instruments are located were taken right after the last whole hour measurements before sensor cleaning or retrieval. Water temperature and salinity were collected using a handheld YSI data sonde at the pump inlet depth and inside the cooler. Water sample collection followed standard protocols for ocean carbonate chemistry studies (Dickson et al., 2007). 250 mL ground glass borosilicate bottles were used and overflow of at least one bottle volume was ensured. After sample collection, 100  $\mu\text{L}$  saturated mercury chloride ( $\text{HgCl}_2$ ) was injected into the sampling bottle to arrest biological activity, and Apiezon<sup>®</sup> grease was applied to the bottle stopper, which was then secured to the bottle using a rubber band and a nylon hose clamp (Hu et al., 2018).

### SANTA MONICA BAY

Discrete water grab samples are collected quarterly and sent to the City of Los Angeles Environmental Monitoring Division for analysis of pH and alkalinity. In addition, LACSD conducts CTD casts quarterly at a nearby station to validate the moored sensor data.

### SAN FRANCISCO ESTUARY

Discrete samples are collected every six weeks, at a minimum, at the surface and at depth with a Niskin bottle adjacent to the pH sensors. The duplicate or triplicate samples are collected in borosilicate bottles, fixed immediately with  $\text{HgCl}_2$  and stored for later analysis of pH and total alkalinity. Chlorophyll *a* and nutrient samples are also collected. A CTD cast is also done at the time of sampling. Sampling coincides with service visits.

### TILLAMOOK ESTUARY

At EPA ORD deployment, duplicate discrete water samples are collected every 2 to 4 weeks during the servicing/cleaning of the instruments. Water samples are collected *in-situ*, adjacent to the sensor array using an 8-liter Niskin bottle. Duplicate water samples are transferred to 330 mL amber glass bottles using standard methods for dissolved gas sampling and poisoned with 30  $\mu\text{L}$  of  $\text{HgCl}_2$  and capped. The water samples are analyzed for  $p\text{CO}_2$  and DIC by US EPA using a carbonate chemistry analyzer designed and built by Burke Hales (Oregon State University).

At the Tillamook Estuaries Partnership monitoring location water is also filter through a Whatman Puradisc 25 GF/F disposable filter device using a plastic 60 ml syringes with luer-lock connector. The water sample is collected in a HDPE 30ml wide mouth Nalgene bottle. The samples are then placed in a -20-degree freeze for end of season analysis for dissolved nutrients.

## 3.5

### Data Collection, Processing and Storage Methods

Six of the ten NEPs have wireless telemetry capability which is described in the table below. The four NEPs without telemetry (Casco Bay, Coastal Bend Bays, Santa Monica Bay, and Tillamook Estuary) retrieve the sensors on a regular basis, and the data are downloaded directly from the sensors or data logger. Sensor and discrete sample data are stored in-house at the NEPs or at partner organizations (e.g., US EPA ORD, universities, state agencies). Telemetered data from some of the NEPs are then uploaded and hosted on university or agency websites. Some of the websites provide data query, download, and graphic capabilities.

Each NEP site follows their own quality assurance/ quality control procedures. In general, these NEP sites conduct annual recalibration of the sensors with the manufacturer and use calibration coefficients provided by the manufacturer for sensor deployments. As described in Section 3.4, discrete samples are collected to validate the *in situ* sensor measurements. Some monitoring groups check instrument performance in a tank prior to and subsequent to deployment. Data from sensors are reviewed, flagged, and verified by using

various techniques including rejecting data beyond specified ranges, rejecting data if inconsistent with known chemistry of the system, and identifying outliers by examining interrelationships between parameters. Examples of quality assurance/ quality control procedures can be found here:

Tampa Bay: <https://pubs.er.usgs.gov/publication/ofr20191003>

Barnegat Bay: <https://www.barnegatbaypartnership.org/protect/barnegat-bay-science-and-research/quality-control-and-quality-assurance/>

Casco Bay: <https://www.cascobayestuary.org/publication/ocean-and-coastal-acidification-monitoring-in-casco-bay-cbep-quality-assurance-project-plan-qapp/>

A description of the data collection, processing, and storage methods used by each of the NEPs is presented below, followed by the challenges and lessons learned regarding data management, data interpretation, and data quality.

## DATA COLLECTION, PROCESSING, AND STORAGE METHODS

### CASCO BAY

**Data Collection Interval:** Hourly

**Data Retrieval:** No telemetry because the dock at Southern Maine Community College does not have the power and data links at this time. Every 4 to 6 weeks, the system is retrieved, and data are downloaded from the instruments in text file format. Each instrument produces a time stamp and data stream.

**Data Processing:** Data are run through a series of Matlab programs to produce a final hourly Excel file. The pH data from the SeaFET sensor are corrected for salinity. The SeaFET software corrects for oxygen. Pulled into Level 1 file: raw data corrected for temp. and salinity; Level 2: flag data gaps or bad data; Level 3: final data product. Use the discrete pH data to do a ballpark matchup with pH sensor data.

Omega is calculated on an hourly basis using a Matlab computer software package called CO2SYS that is based on dissociation constants of carbonic acid (Lewis and Wallace, 1998). Using simultaneous measurements of pH,  $p\text{CO}_2$ , temperature, and salinity. CO2SYS calculates aragonite and calcite saturation state, as well as total alkalinity and DIC.

**Data Storage and Access:** Data are currently stored and processed at UNH, but ultimately sent to Casco Bay Estuary Partnership. There is a desire to integrate the data into the NERACOOS data architecture as well.

## DATA COLLECTION, PROCESSING, AND STORAGE METHODS

### MASSBAYS

**Data Collection Interval:** 15 minutes

**Data Retrieval:** Cellular telemetry will transmit the collected data to the Center for Coastal Environmental Sensing Networks (CESN) at University of Massachusetts, Boston in real time.

**Data Processing:** No data collected to date.

**Data Storage and Access:** Data will be stored at CESN at UMass Boston. Following data QA/QC, the data will be submitted to NERACOOS. That organization has agreed to include MassBays' data in a new web-based module to share coastal acidification data. The data will be made public through [neracoos.org](http://neracoos.org).

### LONG ISLAND SOUND

**Data Collection Interval:** 15 minutes

**Data Retrieval:** Data telemetry

**Data Processing:** Data are initially stored in a database as provisional. As QA/QC protocols are developed and installed, the data are reviewed and flagged as to quality and archived for public access.

**Data Storage and Access:** The pH data are provisional and are not publicly available from the internet. Data for other parameters are shared publicly via the University of Connecticut LISICOS website (<http://lisicos.uconn.edu>). Complete dataset is archived at University of Connecticut (Jim O'Donnell's Lab).

### BARNEGAT BAY

**Data Collection Interval:** 30 minutes

**Data Retrieval:** The data are both stored internally and transmitted to a Campbell datalogger. A cellular telemetry network relays the data on an hourly basis back to the NEP.

**Data Processing:** [No information provided.]

**Data Storage and Access:** Data are stored with Dr. James Vasslides at Ocean County College. Data from the YSI instrumentation is shared with the NJ DEP webpage, where it is possible to view data in real time and share archived post-QC data (<http://njdep.rutgers.edu/continuous/>). The CO<sub>2</sub> Pro and SeaFET data are not currently available on the website; there is a note indicating that these data can be requested.

## DATA COLLECTION, PROCESSING, AND STORAGE METHODS

### TAMPA BAY

**Data Collection Interval:** Hourly

**Data Retrieval:** The Tampa Bay Land/Ocean Biogeochemical Observatory (LOBO), Ocean Carbon System (OCSv2) system uses an Integrated Seabird Storx data logger to collect variable and common time and date and communicates with the LOBOviz cellular telemetry system. The OCSv3 system is integrated into the existing COMPS C12 Campbell Scientific logger and satellite telemetry system. The OCSv3 data are served online on the existing COMPS C12 data website and transmitted via the NOAA GOES satellite system.

**Data Processing:** Data delivered via telemetry are raw data values as output from each sensor. All raw sensor data are synthesized approximately quarterly and undergo preliminary QA/QC using a manual two-step procedure to remove outliers. During the first step, data beyond acceptable measurement ranges for the sensors are flagged to indicate bad data. After preliminary QA/QC of sensor data, advanced data processing is performed. The SeapHOx pH data are corrected to salinity and temperature of the Sea-Bird SBE 37-SMP-ODO MicroCAT C-T-ODO (P) Recorder data through a MS Excel macro provided by Satlantic. The Satlantic macro is also used to perform a single point calibration of the SeapHOx pH data using discrete pH measurements determined *in-situ* and concurrently with OCS sample acquisition. Discrete pH measurements are performed using spectrophotometric pH methods. Once corrections have been completed, parameter data are plotted to examine sensor performance and identify non-trending outliers. Cross validation of sensor parameters is performed to further analyze outliers and identify questionable or bad data points. Further validation of pH and CO<sub>2</sub> sensor data is performed by comparing sensor values to values measured in discrete water samples throughout the duration of deployment. Discrete pH is measured using spectrophotometric measurements. CO<sub>2</sub> is calculated from discrete measurements of pH and dissolved inorganic carbon (performed using carbon coulometry methods).

**Data Storage and Access:** Land/Ocean Biogeochemical Observatory (LOBO), Ocean Carbon System (OCS) data is provided in near real-time through an interactive website called LOBOviz at <http://tampabay.loboviz.com/>. LOBOviz can be used to see data in real time and graph any parameter using archived data. These data are not quality assured, but incorrect data can be excluded, for example when the sensor is being moved. Quality assured data are archived at USGS and are available online as a USGS Data Release: <https://coastal.er.usgs.gov/data-release/doi-P9BAFC7L/>. Data quality is indicated using the data flagging approach of NOAA National Centers for Environmental Information (NCEI) [https://www.nodc.noaa.gov/GTSP/Document/codetbls/gtsppcodes/gtspp\\_qual.html](https://www.nodc.noaa.gov/GTSP/Document/codetbls/gtsppcodes/gtspp_qual.html)

The OCSv3 can be viewed at: <http://comps.marine.usf.edu>.

### MOBILE BAY

**Data Collection Interval:** Every 30 minutes

**Data Retrieval:** No telemetry. Data will be stored on instruments and downloaded periodically

**Data Processing:** No data collected yet

**Data Storage and Access:** Data will be archived and made available via the ARCOS site (<https://arcos.disl.org>)

## DATA COLLECTION, PROCESSING, AND STORAGE METHODS

### COASTAL BEND BAYS

**Data Collection Interval:** Hourly

**Data Retrieval:** No telemetry. Data collected by the sensors (pH,  $p\text{CO}_2$ , salinity, and temperature) were saved in the onboard data loggers for periodic download during biweekly or monthly trips to the UTMSI pier. During servicing of the instruments, the SAMI- $\text{CO}_2$  and SeaFET sensors were taken out of the cooler, and the cooler was cleaned to remove sediment. Data from the prior deployment period were then downloaded to a laptop computer before placing the sensors back into the cooler.

**Data Processing:** [No information provided.]

**Data Storage and Access:** Real-time data not hosted online. Data are archived at Texas A&M University – Corpus Christi.

### SANTA MONICA BAY

**Data Collection Interval:** Hourly

**Data Retrieval:** No telemetry. Data are downloaded directly from the devices on a quarterly basis.

**Data Processing:** Data analysis is conducted by the Los Angeles County Sanitation District. An Excel spreadsheet and Macro utility CO2SYS (Lewis and Wallace, 1998) were used to calculate the  $\Omega_{\text{arag}}$  levels for every data record with a valid pH and  $p\text{CO}_2$  reading (LACSD, 2019).

**Data Storage and Access:** Data are archived at Southern California Coastal Water Research Project (SCCWRP) and in house.

### SAN FRANCISCO ESTUARY

**Data Collection Interval:** 1 hr/15 minutes

**Data Retrieval:** Surface mooring has data telemetry. However, the NEP has been unable to connect the newer SeaFET with the telemetry system, so pH data are downloaded from the sensor. The deep-water mooring does not have telemetry, and the sensors are retrieved every six to eight weeks for service and data download.

**Data Processing:** [No information provided.]

**Data Storage and Access:** Telemetered data go through NOAA Pacific Marine Environmental Laboratory (PMEL) and are uploaded to an ERDDAP server, and then broadcast on the San Francisco State University Estuary and Ocean Science Center (EOS) webpage (<http://coastalobservations.sfsu.edu/tiburón>). Data are archived on the ERDDAP server (<https://oceanview.pfeg.noaa.gov/erddap/tabledap/rtcco2buoy.html>) and are sent to the Central and Northern California Ocean Observing System (CeNCOOS) data portal as well. (<https://data.cencoos.org/>). The NEP downloads and stores the data locally on Cloud-based servers.

## DATA COLLECTION, PROCESSING, AND STORAGE METHODS

### TILLAMOOK ESTUARY

**Data Collection Interval:** 15 minutes

**Data Retrieval:** No telemetry. During regular 2-4-week servicing, data are downloaded from the sensors.

**Data Processing:** Custom Matlab programs have been coded to post-process SeaFET pH data (both internal and external) using factory, *in-situ* check sample, and laboratory CRM calibration coefficients. Appropriate corrections for temperature, salinity, and pressure are applied. pH results are compared with *in-situ* check samples for measurement offset and/or drift. The SAMI Client program is used to post-process the SAMI-CO<sub>2</sub> data.

**Data Storage and Access:** Real-time data are not hosted online. The downloaded data are archived at the US EPA ORD and will be transferred to the NEP for archiving. Oregon Department of Environmental Quality (DEQ) has agreed to support data management and long-term data storage for the project. DEQ will assimilate continuous and discrete data from the project into its Ambient Water Quality Monitoring System (AWQMS). The AWQMS database is publicly accessible and will be used for data sharing and storage.

## 3.6

### Cost Information and Funding Sources

Understanding the full cost of coastal acidification monitoring with continuous sensors requires characterization not only of the capital cost of the equipment, but also the cost of regular maintenance and service, data collection, and analysis. Below is a summary of approximate cost information provided to EPA by the NEPs identified in this report for the acquisition, calibration, maintenance, and operation of their acidification instruments. In addition, examples of funding sources that these NEPs use to conduct these programs are also provided.

#### Equipment/Sensor Approximate Cost

- pH sensor: \$11,500–\$12,000
- pCO<sub>2</sub> sensor: \$15,000–\$17,500
- Telemetry system: \$12,500–\$15,000
- YSI Exo2 sondes and probes: \$28,000
- Frame fabrication: \$4,000–\$6,500
- Mounting package hardware: \$2,500
- Installation: \$600–\$800 in materials and \$750 in labor.
- Significant cost savings have been achieved by using existing moorings or buoys and as more experience is gained in the deployments.

### **Annual Calibration Approximate Cost**

- pH sensor: \$1,500–\$3,000
- $p\text{CO}_2$  sensor: \$1,000–\$2,500
- YSI Exo2–\$750
- EcoPAR: \$625
- CT (Conductivity, Temperature) Sensor: \$350

### **Annual Maintenance and Operations Approximate Cost**

- Personnel: Typically, two technicians are needed for field, lab and data analysis work (e.g. \$40–70,000/year + fringe benefits, indirect costs per person, this estimate varies)
- Discrete sampling–\$7,000
- Laboratory costs: \$2,000 (such as consumables; Dickson Certified Reference Material (CRMs))
- Equipment replacement and repair: See equipment cost above
- Telemetry annual maintenance fee for web and technical service–\$2,000 (less in some cases)

### **Funding Sources**

- EPA Office of Wetlands Oceans and Watersheds, Ocean and Coastal Acidification program funding for sensor purchase and EPA Office of Research and Development
- EPA funding CWA Section 320 Comprehensive Conservation and Management Plan (CCMP)
- The NEPs provide in-kind match of staff time, laboratories or vessels
- Some NEP partners provide funding
- Regional Integrated Ocean Observing Systems (e.g. Central and Northern California Ocean Observing System (CeNCOOS) support for San Francisco Bay)

# Deployment and Data Management Challenges and Lessons Learned

---

## 4.1

### Deployment Challenges and Lessons Learned

Several of the NEPs identified in this report experienced challenges deploying their equipment and have developed unique approaches to resolving these problems. Their experiences are lessons for future monitoring efforts. A top challenge was found to be biofouling which inhibits effective sensor operation. These NEPs addressed this issue with frequent cleaning and by working directly with the manufacturers to develop copper fittings, using copper duct tape, sheets and antifouling paint. Other challenges were difficult weather conditions, such as winter icing and hurricanes, and red tides that prohibit dive operations. These situations result in the temporary cessation of the sensor deployments and consequently data gaps. Two NEPs avoided biofouling and inhospitable environmental conditions by deploying the instruments in weatherproof coolers with flow-through systems. The ability to incorporate telemetry to transmit data real-time

was seen as a very valuable asset to allow the NEPs to know about an equipment failure and or other reason for a lapse in data collection. However, incorporating telemetry can be a challenge if there is not a land-side power source or insufficient solar power at the deployment site. To address several of the challenges, these NEPs recommend purchasing redundant sensors so that one sensor can be exchanged for another if cleaning is needed due to biofouling, there are delays in calibration or repair of the equipment at the manufacturer, a malfunction occurs or other issues. This practice minimizes any gaps in data collection. However, all of these NEPs found it cost prohibitive to purchase additional sensors. Below is a summary of the various deployment challenges and lessons learned by the NEPs conducting coastal acidification monitoring.





## CHALLENGES

## LESSONS LEARNED

### COSTS

- The cost of sensors is changing, but they remain expensive.
  - As a result, when the sensors are out of the water for calibration, maintenance, or data download (if there is no telemetry), then data gaps result. It is often cost prohibitive to purchase a redundant sensor.
  - It is difficult to find an entity to insure the equipment. Tillamook Estuaries Partnership can Casco Bay insured their equipment.
  - One of the buoys (ARTG) is pulled during the winter (Long Island Sound).
  - It is difficult to predict repair costs for any given funding year.
  - Building an innovative system for year-round deployment is more costly and challenging, therefore taking longer (MassBays).
- Opt for sensor redundancy and telemetry at each site, if budget allows, to solve many challenges (multiple NEPs).
  - Develop better cost estimates for long term maintenance and replacement of the sensors (Santa Monica Bay).

### ENVIRONMENTAL CONDITIONS

- Icing during winter can lead to equipment freezing (Casco Bay, MassBays, Barnegat Bay).
  - Pier where sensors were deployed was destroyed by Hurricane Harvey (Coastal Bend Bays).
  - It is difficult to get access to sensors in the fall and winter due to weather (Long Island Sound).
  - The dock can get significant splash over during storms and the pumping housing can warp due to cold temperatures (MassBays).
  - During red tide, no dive operations can occur (Tampa Bay).
  - Storm events dragged moorings, with one lost. (Tillamook Estuary).
- Pull equipment in winter or deploy in a cooler on a pier (Casco Bay, Long Island Sound, MassBays, Barnegat Bay).
  - Use a flow-through pumping system so that they sensors are not immersed in seawater (MassBays).
  - To avoid downtime due to red tide, reinvent mounting package. Installed lever arm to raise equipment to surface for maintenance during red tide. This helped to reduce lapses in data and equipment failures due to biofouling. The use of scrap materials resulted in a cost savings of \$1000 (Tampa Bay).

## CHALLENGES

## LESSONS LEARNED

### LOCATION/SITING

- Deployment location has 12 ft tidal ranges, creating very shallow (<3 ft) conditions at low tide (MassBays).
  - Deployment of array was selected so not to be unduly influenced by point sources and to avoid discharge plumes (Santa Monica Bay).
  - Due to boat strikes on the mooring, equipment was breaking free from mooring and from the buoy (Santa Monica Bay).
  - Tillamook Estuary is a shallow bay with strong tidal forcing, difficult to navigate. The initial EPA ORD deployment site was chosen at a site that is always submerged and not emergent. The additional deployment by Tillamook Estuaries Partnership was placed in a more central location in the bay
- Use floating pump for constant depth sampling (MassBays).
  - Use existing pilings or buoys for equipment deployment that results in cost savings and co-located data (Long Island Sound, Tampa Bay, Santa Monica Bay, Tillamook Estuary). For example, Tampa Bay saved \$200,000 by using an existing piling for their deployment.
  - To try to avoid boat strikes, use a radar reflector surface spar buoy and file a notice to mariners with the Coast Guard identifying the location of the mooring (Santa Monica Bay).

### LOGISTICS

- Design and construction of a flow-through system took longer than anticipated (MassBays).
  - Concern about the adequacy of solar power to run telemetry resulted in redesigning to make the system run on the electrical grid. Logistical challenges to obtain power resulted in a longer process to deploy the system (MassBays).
  - No real-time power/data available, no running water at the pier. If power was available, the site would be ideal for very robust sampling (Casco Bay).
  - Occasional pump or sensor failures; discovered only after checking on the site (no telemetry to diagnose problems in real time) (Coastal Bend Bays).
  - No spare instrumentation when malfunctions happen. At the mercy of the manufacturer to fix equipment and ship back (San Francisco Estuary, Barnegat Bay, Casco Bay).
  - Sensor and equipment outages – cost for charter on boat for extra day to travel and service equipment (San Francisco Estuary).
- Use sensor redundancy and telemetry at each site to solve many challenges (multiple NEPs).
  - Consider reliability of solar vs. landside power to run telemetry system. Chose year-round landside power to be installed at the deployment pier to avoid concerns of the inadequacy of solar (MassBays).
  - Remove data during known instances of pump failure (Coastal Bend Bays).

## CHALLENGES

## LESSONS LEARNED

### DESIGN

- Constructing a custom-made system to fit the sensors inside a weatherproof housing resulted in increased time and cost versus using off-the-shelf materials (MassBays).
- Integrating sensors together (three different manufacturers) resulted in uncertainty about where to send the array for service and calibration (Barnegat Bay).
- Delay in deployment due to manufacturer's error in instrument assembly (Santa Monica Bay, Tillamook Estuary).
- Uncertainty regarding battery life for long deployments (Santa Monica Bay).
- The SeaFET instrument flooded. The NEP staff did not realize there was a flooding issue, because no telemetry is available at the deep-water deployment location and the instrument was deployed for a long time period before the issue was found. The instrument was sent to Seabird, who did not know why it flooded. They said it was a manufacturing error, and they would fix it for free (San Francisco Estuary). However, Seabird did not provide a free replacement in a similar situation at the Tillamook Estuaries Partnership deployment.
- Due to the problems experienced with surface deployment of the SeaFET (not even under pressure) and concerns about the design of the SeaFET case, a non-commercial case was deployed multiple times mostly without incidence (San Francisco Estuary).
- Modify sensors to fit into the weatherproof housing unit (MassBays).
- Ensure these sensors are robust for long-term deployments (Long Island Sound).
- Be creative. For example, develop a sliding rail system to allow easy access for cleaning the devices quickly and efficiently (Barnegat Bay).
- Encourage two-way learning exchanges between the sensor manufacturers and researchers (Tampa Bay).
- Confidently secure sensors to the mooring and safely retrieve by using a custom strongback cage and utilize telemetry to alert NEP staff of instrument failure (Santa Monica Bay). Consider deploying a non-commercial version of the sensor case (particularly the SeaFET case) due to design flaw with commercial case (San Francisco Estuary).
- Battery life will be tested when the instruments are serviced in July (Santa Monica Bay).

## CHALLENGES

## LESSONS LEARNED

### BIOFOULING

- Biofouling of the sensors is a challenge for most of the NEPs, including Santa Monica when the sensors were deployed at the 50 feet depth (but not at the 200-foot depth).
- The pH and  $p\text{CO}_2$  sensors both fouled, which led to membrane or sensor failure (Long Island Sound, Tampa Bay, Tillamook Estuary).
- $\text{CO}_2$  probe had barnacle growth inside, which punctured membrane (Tampa Bay).
- Main challenge was biofouling with  $\text{CO}_2$  Pro CV – high eutrophic estuarine environment (Barnegat Bay).
- Siltation which appears to be uneven across devices (Barnegat Bay).
- Potential siltation issue in which sediment accumulated in the pH sensor housings where it got partially buried (Casco Bay).



*Biofouling  
(Casco Bay)*



*Biofouling  
(Santa Monica Bay)*



*Biofouling  
(Long Island Sound)*



*Biofouling  
(Barnegat Bay)*



*Biofouling  
(Tillamook Estuary)*

- Double the number of sensors to minimize the impact of biofouling because the sensors could be swapped out and cleaned in the lab, if budget allows (multiple NEPs).
- Frequently clean the sensors (e.g., every two to three weeks during summer/fall) to remove biofouling (Casco Bay, Long Island Sound, Barnegat Bay, Tampa Bay, Tillamook Estuary). For Casco Bay, cleaning every 4-6 weeks was more realistic given time and resource constraints.
- Deploy sensors in PVC tube with antifouling paint (inside and out) (Barnegat Bay).
- Develop a sliding rail system (Barnegat Bay) or pulley system (Tillamook Estuary) to allow the cleaning of the devices quickly and efficiently.
- To overcome biofouling, work with manufacturer to develop copper fittings to use at instrument flow inflow points. Reinvent mounting system using copper plating and wrap instruments in copper tape to combat biofouling (Tampa Bay).
- Increase flow rate through SeapHOx by routing outflow from  $\text{CO}_2$  Pro to SeapHOx to help prevent sedimentation inside of measurement chambers.
- Deploy the instruments in a cooler to reduce biofouling (Coastal Bend Bays).
- Use a flow-through pumping system to avoid biofouling on sensors altogether (MassBays).
- Swap out the YSI sensor and replace it with another pre-calibrated YSI during service trips instead of cleaning one sensor biofouling at each visit, especially during seasonal increased temperatures when biofouling increases and substantial drift in the salinity signal can occur (Coastal Bend Bays, Tillamook Estuary).
- Make modifications such as copper sheeting on key parts of the instruments, and a minimal amount of slow-dissolving tributyltin in the SeapHOx water intake opening (Santa Monica Bay).
- Keep spare instruments so one can be swapped out while one is being serviced and cleaned in the laboratory (Long Island Sound, Tillamook Estuary).

## CHALLENGES

## LESSONS LEARNED

### CALIBRATION/MAINTENANCE

- Most of the NEPs have found that manufacturers' calibration of the sensors, which is usually conducted annually, is both costly and time consuming. It can take months to get the calibrated instrumentation back from the manufacturer, which results in large breaks in the data when back up instruments are not available. For example, Casco Bay indicated that the Satlantic SeaFET and SAMI-CO<sub>2</sub> both have a 2 to 3-month turnaround time for calibration that can result in data gaps.
- SAMI-CO<sub>2</sub> performance pre-check is done at UNH Coastal Marine Lab (Casco Bay).
- SeapHOx and CO2Pro validation is performed at USGS Carbon Lab prior to deployment (Tampa Bay).
- The instruments are not satisfactorily robust yet and require a lot of fixing and cleaning. (Long Island Sound)
- The NEPs must rely on the manufacturers for annual maintenance (Santa Monica Bay).
- The NEP saw biofouling issues starting with the CO<sub>2</sub> sensor (Barnegat Bay).
- Issues related to ionic strength/salinity dependence of SeaFET and SeapHOx pH measurements. Tidal flushing results in rapid salinity changes that exceed the response time of the external reference electrode (Tillamook Estuary).
- Use a Seabird instrument to perform the calibration of the SeaFET. Use a certified Tris buffer from A. Dickson to perform a one-point calibration check of SeaFET, but this is not always a reliable solution (Casco Bay).
- Use a flow-through design to reduce the need for factory-dependent calibration (the system includes internal standards for calibration of the IR detector) (MassBays).
- Use a redundant SAMI sensor deployed side-by-side in the laboratory to compare the results of both sensors (Tillamook Estuary).
- Participate in monitoring partnerships to advance the technology (Long Island Sound).
- Only use pH<sub>int</sub> measurements with SeaFET and SeapHOx. Use multiple calibration coefficients to calculate pH, including those from factory, *in situ* check samples analyzed for pH, and lab-based Dickson CRM checks (Tillamook Estuary).
- Use discrete water sampling and concurrent sensor measurements in the laboratory to validate system performance (Tampa Bay).
- Collect adequate, contemporaneous QA/QC samples to compare to sensor results to address calibration and biofouling errors (Casco Bay).

## CHALLENGES

## LESSONS LEARNED

### INSTRUMENT MALFUNCTION/FAILURE

- In 2015, the SAMI-CO<sub>2</sub> had an issue with blank readings and UNH removed the sensor in post-processing (Casco Bay).
  - In 2016, the SAMI-CO<sub>2</sub> temperature sensor failed and UNH removed the data in post-processing (Casco Bay).
  - The SeaFET was retrieved on January 25, 2017. Readings were consistently two times measurement units higher than the EXO2 sensor. The instrument was serviced at Seabird from January 30, 2017 to June 2017 and found the device had a bad DuraFET sensor (Barnegat Bay).
  - The CV-Pro was down for two months due to user error in the end of the summer of 2017, and then a bad power supply board in Spring 2018. In the summer of 2019, there was a mystery short that has taken out the telemetry system, CV-Pro, and SeaFET (Barnegat Bay).
  - Lapses in telemetry were periodically caused by flooding of the modem, and or failure of communications and instrument cables due to biofouling (Tampa Bay).
  - Field cleaning introduced moisture into the unit. The problem was quickly diagnosed by Pro-Oceanus (Barnegat Bay).
- Encourage two-way knowledge exchanges between the sensor manufacturers and researchers (Tampa Bay).
  - Identify the weaknesses of the sensors in order to sustain long-term observing systems. Encourage more sensors to be built and deployed so that they become reliable. This project has moved advances in the technology forward substantially (Long Island Sound).
  - Comparisons between YSI pH and SeaFET/SeaPHOX are useful for detecting sensor problems, as well as inter-relationships between variables (Tillamook Estuary).
  - Be careful to keep the SeaFET sensor wet during retrieval (Casco Bay).

## 4.2

### Data Management Challenges and Lessons Learned

#### DATA MANAGEMENT CHALLENGES

- There is a backlog of samples for TA/DIC so calculations for the saturation state (or omega) are not complete (Casco Bay).
- Telemetry and data logger breakdowns; wait for commercial provider to fix (Barnegat Bay).
- Incompatible data format and firewall issues prevent host institution from posting collected data to their website (Barnegat Bay).
- Telemetry is user friendly and versatile, but when it breaks, need to wait for commercial provider to fix connection (Tampa Bay).
- Issues with individual sensors not connecting to the telemetry system. For example, sensor firmware update broke the code that links to the instruments. This happened to the pH instrument, which was collecting and sending raw files but connection to LOBOviz was broken after firmware updates.
- Changing telemetry system because Seabird is closing offices that designed and engineered LOBOviz data management software, prefer to control the system in-house (Tampa Bay).
- No telemetry at the site at any point during the data collection period. Unable to identify and diagnose equipment and pump failures in real-time (for example, four months of data lost due to biofouling contamination) (Coastal Bend Bays, Santa Monica Bay).
- Lack of funding for data quality control and data management (San Francisco Bay).

#### DATA MANAGEMENT LESSONS LEARNED

- Ensure that institutional knowledge and documentation exists before using or changing telemetry systems (Barnegat Bay).
- Use a telemetry system that you and your partners have the ability to fix if issues occur. For example, Tampa Bay is looking to move to a cellular telemetry system at University of South Florida, funded by Southeast Coastal Ocean Observing Regional Association (SECOORA) because it can be fixed in-house. The system is run by NOAA and universities.
- Use the Ocean Acidification Information Exchange to post your web data and share comments about when instruments down or in lab (Tampa Bay).
- Share real-time updates related to data (Tampa Bay).
- Have a system with telemetry, it's important for data continuity (San Francisco Estuary).
- Partner with the regional IOOS systems. CeNCOOS has invested in the data system, so NEP's level of effort to post data has been small. One of their priorities is to share the data (San Francisco Estuary).
- Understand that all of the regional IOOS systems run differently and have different governance and different priorities. It depends on the regional organization how it would work (San Francisco Estuary).

## 4.3

### Data Interpretation Challenges and Lessons Learned

#### DATA INTERPRETATION CHALLENGES

- Guidance from EPA on which data to report would be helpful (Casco Bay).
- Development of management and outreach ideas for the next report (Casco Bay).
- Lower quality sensors are picking up diurnal changes and algal blooms, but to calculate saturation state, more expensive equipment may be required (Casco Bay).
- Comparison of data between NEP, Friends of Casco Bay and Bigelow, which use instruments of varying precision (Casco Bay).
- Measuring changes is difficult because of the large fluctuations in pH. A decade of data will be required to detect trends in pH and the link between DO and pH (Long Island Sound).
- Comparison of discrete versus continuous data – different temporal scales and methodologies (Barnegat Bay, Tampa Bay).
- Lack of funding for data interpretation (San Francisco Bay).
- Due to strong tidal forcing and highly advective environment, rapid changes in carbonate chemistry can occur which hinders assessing accuracy through comparison of discrete and continuous data (Tillamook Estuaries).

#### DATA INTERPRETATION LESSONS LEARNED

- Due to annual variability, be careful about making generalizations about the data from one year to the next (Casco Bay).
- Ensure that other types of associated *in situ* data (chlorophyll *a*, nitrogen, PAR) are collected in order to interpret acidification in the context of inshore processes, such as hydrodynamics, mixing, primary production, etc. (Casco Bay).
- Use high quality equipment, like these sensors, to attract high quality partners with expertise (Casco Bay).
- Look at similar coastal acidification questions across the country with common hypotheses (Casco Bay).



## 4.4

### Data Quality Challenges and Lessons Learned

#### DATA QUALITY CHALLENGES

- Writing the Quality Assurance Management Plan (QAPP) for this monitoring program was a challenge (Casco Bay).
- Efforts to cross calibrate with other organizations is a challenge when they are using lower quality equipment (comparing apples and oranges) (Casco Bay).
- The SeaFET was shipped from the manufacturer with bad sensors. Redundant measurements made on EXO instrument and discrete samples showed lots of drift in the SeaFET measurement (Barnegat Bay).
- The pH and CO<sub>2</sub> data validation (*in situ* versus discrete) (Tampa Bay).
- Data needs to be removed during known instances of pump failure (Coastal Bend Bays).
- Observed potential issues with SeapHOx pH data collected during the latter part of the second year that are being addressed with the manufacturer (Santa Monica Bay).
- Delays in receiving the discrete sample data from an analytical laboratory hinder ability to detect issues with instrumentation (Tillamook Estuary).

#### DATA QUALITY LESSONS LEARNED

- Attract high quality monitoring partners like UNH, to bring a level of expertise that is unparalleled (Casco Bay).
- Use high quality data to show that the NEP is obtaining a good understanding of the carbonate system in the estuary (Casco Bay).
- Select periods with no data collection problems (such as biofouling) to highlight high quality data (Barnegat Bay).
- Improve accuracy of *in situ* versus discrete data by improving the timing of sampling to avoid fast currents, improving temperature control, and shortening the length of the sampling tube from the boat to the sensor. Time sampling to slack tide (Tampa Bay).
- Need to correct discrete pH measurements analyzed in the lab to *in situ* temperature and pressure before comparison with field sensor measurements (Santa Monica Bay).
- Discrete samples from Tillamook are now being analyzed for *p*CO<sub>2</sub> and TCO<sub>2</sub> by US EPA ORD to reduce delays in analysis of discrete samples (Tillamook Estuary).

# Monitoring Partnerships and Public Outreach

## 5.1

### NEP Monitoring Partnerships

In order to conduct these intensive and technologically advanced programs, the NEPs identified in this report have built partnerships to share information and maximize limited funds. Below is the list of the NEP's partners and their roles in the coastal acidification monitoring programs.

NEP MONITORING PARTNERS	
EAST COAST	
Casco Bay	<ul style="list-style-type: none"> <li>• U.S. EPA Region 1 (project management)</li> <li>• University of New Hampshire (conducts the monitoring, sensor maintenance, data collection and processing)</li> <li>• Southern Maine Community College (location for monitoring)</li> </ul>
MassBays	<ul style="list-style-type: none"> <li>• The Center for Coastal Environmental Sensing Networks (CESN), University of Massachusetts Boston (system design, construction and deployment)</li> <li>• North &amp; South River Watersheds Association (train citizen scientists for the collection of discrete samples)</li> <li>• U.S. EPA-Office of Research and Development (ORD) Atlantic Ecology Division, Narragansett, RI (discrete sample analysis)</li> </ul>
Long Island Sound	<ul style="list-style-type: none"> <li>• University of Connecticut (conducts the monitoring including operating the buoy system, maintaining instruments, and data sharing)</li> <li>• University of Connecticut Long Island Sound Integrated Coastal Observing System (LISICOS) (provides buoys for instrumentation deployment, data hosting)</li> </ul>
Barnegat Bay	<ul style="list-style-type: none"> <li>• NOAA NMFS James J. Howard Marine Sciences Laboratory and Milford Laboratory (quality control, discrete sampling, data analysis)</li> <li>• N.J. Department of Environmental Protection, Bureau of Marine Water Monitoring (provides technical assistance with telemetry systems and houses real-time data and archived data portal)</li> </ul>
GULF OF MEXICO	
Tampa Bay	<ul style="list-style-type: none"> <li>• U.S. Geological Survey, St. Petersburg Coastal and Marine Science Center (conducts monitoring, data collection and data analysis)</li> <li>• University of South Florida Physical Oceanographic Real-Time System (PORTS) and the Coastal Ocean Monitoring and Prediction System (COMPS) provides use of existing monitoring platforms for deployment of monitoring packages and annual research vessel support for offshore system maintenance.</li> <li>• USF Center for Ocean Technology provides engineering and data management assistance for linkage of offshore monitoring system to the COMPS telemetry, data delivery and data storage system.</li> </ul>

## NEP MONITORING PARTNERS

Mobile Bay	<ul style="list-style-type: none"> <li>• University of South Alabama (conducts monitoring, data collection, and data analysis)</li> <li>• Alabama’s Real-Time Coastal Observing System and Dauphin Island Sea Lab provides the web site for hosting the data (<a href="https://arcos.disl.org">https://arcos.disl.org</a>), the platform for deploying the instruments, and ship time and technician support for maintaining the instruments</li> <li>• Funding to purchase the instruments, perform the bay-wide discrete sampling, and data analysis and interpretation is provided by a competitive grant from the NOAA Restore science program.</li> </ul>
Coastal Bend Bays	<ul style="list-style-type: none"> <li>• Texas A &amp;M University—Corpus Christi (conducts the monitoring, data collection and data analysis)</li> <li>• University of Texas Marine Science Institute (UTMSI) (provided the deployment platform and helped with designing and mounting the monitoring structure on their research pier)</li> <li>• Mission-Aransas National Estuarine Research Reserve (MANERR) (provided monitoring data [salinity and temperature] for cross validation)</li> </ul>
<b>WEST COAST</b>	
Santa Monica Bay	<ul style="list-style-type: none"> <li>• City of Los Angeles Environmental Monitoring Division (analyzes discrete measurements)</li> <li>• Los Angeles County Sanitation Districts (maintains the OAH sensors and mooring, including deployment, retrieval, all servicing and data downloading, conducts supplemental monitoring (e.g. CTD), and manages data analysis)</li> <li>• Southern California Coastal Water Research Project (SCCWRP) (archives the data)</li> </ul>
San Francisco Estuary	<ul style="list-style-type: none"> <li>• Estuary and Ocean Science Center, San Francisco State University (conducts the monitoring, data collection and data analysis)</li> <li>• Coastal Marine Sciences Institute, University of California Davis (shares staff, technical expertise, conducts data analysis)</li> <li>• CeNCOOS (houses the data, QA/QC of telemetered data)</li> </ul>
Tillamook Estuary	<ul style="list-style-type: none"> <li>• U.S. EPA Office of Research and Development (ORD) Center for Public Health and Environmental Assessment (conducts the monitoring, data collection and data analysis of instrument deployed at Garibaldi). This is funded through US EPA Region 10 (RARE Project) and US EPA ORD funding.</li> <li>• Oregon Department of Environmental Quality (Manages and provide long-term data storage. Also contributes to YSI equipment maintenance)</li> <li>• Tillamook Estuaries Partnership (Acquired funding to expand project, implements instrument deployment at second site and partnership coordination for data integration)</li> <li>• Oregon State University (SeaFET maintenance and data analysis)</li> <li>• Oregon Health Sciences University (data analysis)</li> <li>• Oregon Department of Fish and Wildlife (Project integration to state-wide strategy and project implementation in Tillamook Bay)</li> <li>• Pacific Seafood (Project mooring and site support)</li> </ul>

## 5.2

### Partnership Challenges and Lessons Learned

Many of the NEPs have found that establishing robust partnerships has helped to support the execution and advancement of their coastal acidification monitoring programs. By working with universities, federal, state and local governments and other organizations with experience working with continuous monitoring systems they have worked together to creatively advance the equipment and deployments. The NEPs identified in this report have expressed that their participation in this monitoring project has increased the perceived importance of the coastal acidification issues in their region. Below is a summary of the lessons learned and challenges regarding the development of sustainable partnerships to conduct the coastal acidification monitoring.

Casco Bay NEP established the first inshore monitoring of acidification in the region. Their efforts have spurred more coastal acidification monitoring in the Bay using the sensors by three other groups: Friends of Casco Bay (partly funded by CBEP), Bigelow/Island Institute (partly to look at influence of kelp farming); Bowdoin College (located at marine station). This project has helped to change regional thinking and collaboration.

#### PARTNERSHIP LESSONS LEARNED

- Casco Bay has robust partnerships, such as the Northeast Coastal Acidification Network (NECAN), the Maine Ocean and Coastal Acidification Partnership (MOCA) and Ocean Acidification Study Commission, State Ocean and Coastal Acidification Partnership (MOCA) and Ocean Acidification Study Commission, State legislature, aquaculture. Data are helping to fuel conversations, such as the temperature change effect on acidification. They saw that the high-quality monitoring sensors attracted high quality partners with expertise.
- MassBays has a strong relationship with its partners and citizen scientists which makes it easy to coordinate. They will work with their partners to communicate this regional issue of growing importance (coastal acidification and its impact to local shellfish resources). They have begun to communicate with the Harbormaster and local fishermen in the area to make them aware of this project.
- Long Island Sound has found that coordination with NOAA at the level of the regional association and university has been effective.
- Barnegat Bay has found that the shellfish aquaculture community, such as early life stage operators and hatcheries, is interested in the monitoring program. The aquaculture community would like to increase collaboration with other partners conducting water quality monitoring and be more involved. For example, they are interested in learning more about the deployment set up of the NEPs conducting coastal acidification monitoring.
- Tampa Bay found that forming true partnerships is a grass roots effort, which may involve cost sharing and in-kind funding when budgets are tight. Partnerships also provide a solid foundation for proposals. Dedicated effort is required to identify the proper team members who are willing to participate as needed and to motivate and facilitate partnership creation. Demonstrating a need for the monitoring work is also required in order to obtain seed money to get started.

## PARTNERSHIP LESSONS LEARNED

- Santa Monica Bay's acidification monitoring has allowed for the development of a collaborative, multi-discipline team (local, state, federal, non-profit) to work together to solve a common issue. This common interest has helped to decrease adversarial relationships between industry and regulatory groups and improve relationships. Santa Monica Bay is also collaborating with coastal ocean acidification networks in California, such as the Southern California Bight Ocean Acidification and Hypoxia (OAH) modeling project, and the California Current Acidification Network (C-CAN)/Southern California Coastal Ocean Observing System (SCCOOS), to provide data and establish future acidification monitoring locations.
- San Francisco Estuary has found great enthusiasm and interest from the public and a diversity of stakeholders in this work. People are becoming more interested in the lower estuary, which has been understudied. There are also more students working on the project. The California Ocean Protection Council recently funded an eelgrass restoration project in San Francisco Estuary that includes assessing the effects of eelgrass on pH and carbonate chemistry and how the eelgrass may ameliorate ocean acidification.
- A wide variety of partners are involved in Tillamook Estuary's monitoring program, including federal and state agencies, local port authority, universities, and shellfish industry. In addition, the South Slough National Estuarine Research Reserve (NERR) has been conducting coastal acidification work and providing Tillamook Estuaries Partnership with information and assistance. There are also a number of statewide and regional partnerships focused on coastal acidification and hypoxia. The Oregon Ocean Acidification and Hypoxia Monitoring Workgroup brings monitoring partners together and helps to standardize monitoring techniques and share lessons learned. The Oregon Coordinating Council influences state legislation around acidification and hypoxia. The Pacific Coast Collaborative is coordinating ocean and coastal acidification and monitoring across the west coast (Oregon, Washington, California, and British Columbia).

## PARTNERSHIP CHALLENGES

- There is a need for more robust funding and staffing for this type of long-term monitoring program. Two water quality specialists are really required to maintain a sustainable program.
- It is difficult to maintain consistency when monitoring, data analysis, maintenance, calibration, troubleshooting and other critical tasks are done by part-time technicians. Without attractive pay scales, retaining experts can be difficult.
- It is difficult to find sustainable funding for long-term monitoring program. Coastal acidification monitoring is not entrenched in ongoing monitoring programs.
- Research "project" funds won't support the commitment that is needed.
- Partnerships take a long time to evolve and are quite vulnerable at the pilot stage. Sustainable, baseline funding from the state or federal level is needed to maintain long-term monitoring program.
- It can be difficult to gain the attention of funding agencies to support acidification monitoring because local, state and federal agencies are interested in regulatory issues, restoration, and permitting.
- It is important that there is a bridge between the different scientific drivers and needs of academics, local and regional non-governmental organizations and regulators that can satisfy shorter-term scientific studies and longer term management needs.
- It is important to create interest among partners and stakeholders but there are challenges. It can be difficult to get people excited about this type of monitoring. It is a challenge to determine how to publicize this monitoring data to the partners. Long-term datasets are really needed to see trends.

## 5.3

### Public Outreach Efforts

The NEPs see that an important role they play within their study areas is to serve as a platform to engage the public on issues specific to their estuaries. The NEPs have been working to share the status and progress of their coastal acidification programs with their partner organizations and the public via news releases and newsletters. Initial monitoring findings are being presented at scientific conferences and workshops, and informally with shellfish partners and industry.

The NEPs have found opportunities to leverage partner-coordinated events and public interest at the deployment locations themselves to educate the public about coastal acidification and ongoing monitoring efforts.

The NEPs have found some challenges in engaging the public on ocean and coastal acidification issues. It was found that in some areas, it is difficult to get the attention of the public because they are unaware of the status of acidification impacts in their estuary and speaking about climate change impacts can be a difficult topic. They have found that the science is very complex, especially in inshore waters. It is difficult and takes much time to determine how to communicate monitoring results to lay audiences. In the San Francisco Estuary, it was found that people are more interested in the restoration of native species and marshes and eelgrass that is occurring in the lower estuary. There is interest in carbon sequestration and the carbon budget of marshes and eelgrass, but not much interest in the ocean and coastal acidification. The public is interested in the National Marine Sanctuary and the outflow of the bay into the sanctuary.

Another challenge is that there are very limited funds to do public outreach. The funding for the monitoring has been used to get the instrumentation working and obtaining and maintaining data quality. Good data quality is critical for meaningful outreach. A more comprehensive program that included outreach would



*Credit: Christopher Hunt, UNH, Casco Bay*

require more funds to reach the larger public. For example, Long Island Sound communicates with the science community and management agencies in Long Island Sound and there is an additional cost, mainly staff time, associated with greater participation.

These NEPs have shared the following lessons learned in conducting outreach:

- Use the monitoring data to fuel conversations with stakeholders, particularly the shellfish industry (**Barnegat Bay, Casco Bay**).
- Use the monitoring data to support state legislation. Since establishment of the Maine Ocean Acidification Commission, the public is aware of coastal acidification impacts, local fisherman are interested, and acidification gets front page stories in Maine newspapers (**Casco Bay**).
- Use the deployment locations to attract attention. For example, the monitoring at the pier provides visibility for the monitoring program and an opportunity to explain coastal and ocean acidification to the people that visit the pier (**Casco Bay**).
- Use a variety of media outlets and scientific forums to share information about the acidification monitoring, including social media (Facebook), Bay Area Scientific Information Symposium (BASIS) 2015, Tampa Bay Regional Planning Council, Ocean

Acidification Information Exchange ([www.oainfoexchange.org](http://www.oainfoexchange.org)), University of South Florida and Southeast Coastal Ocean Observing Regional Association (SECOORA) news releases, Tampa Bay Water Atlas, Gulf of Mexico Coastal Ocean Observing System (GCOOS) meeting management and policy committee, Science Working Group SOCAN (**Tampa Bay**).

- Publish articles about the monitoring in local newsletters. For example, check out Baywire newsletter ([July-September 2016](#) and [October-November 2016](#)) (**Santa Monica Bay**).
- Participate in local events. For example, EPA ORD participated in the 2016 and 2021 Hatfield Marine Science Days, which is a public outreach event by agencies. Visitors to Hatfield Marine Science Center were given demonstrations of the coastal and ocean acidification instruments. EPA ORD researchers presented a summary of OA monitoring efforts and results at the 2019 Tillamook Science Symposium (Pacella et al., 2021). The goal of the

symposium was to promote projects and expand partnerships. A local retired scientist became interested in contributing volunteer time to the project based on the symposium outreach. Check out the 2021 presentation on [Youtube](#). A summary of the acidification monitoring was incorporated into Tillamook Estuaries Partnership's "[2020 State of the Bays Report](#)" (**Tillamook Estuary**).

- Promote the monitoring program through the education of university students and integrate into student research opportunities. For example, Texas A&M includes the coastal acidification project in its class lectures. They also present the preliminary data at scientific conferences. They have found that although they have a short dataset, it is a good dataset. They presented their data at the Gulf of Mexico Estuarine Biennial Meeting in November 2018 and at the Association for the Sciences of Limnology and Oceanography (ASLO) in February 2019 (**Coastal Bend Bays**).

## Preliminary Monitoring Results

Through their monitoring efforts to date, the NEPs and their partners have begun to observe diel, seasonal, and interannual variability of pH and  $p\text{CO}_2$  and the relationship between these two parameters. They have also analyzed the relationships between carbonate parameters and temperature, salinity, dissolved oxygen and other variables that help distinguish between land-based inputs and ocean influxes (e.g., upwelling). The measured parameters can also indicate biological process such as primary production and microbial decomposition. The preliminary monitoring data show:

- Evidence of the correlation of temperature and salinity with short-term (daily-weekly) and longer-term trends in  $p\text{CO}_2$  concentrations.
- Observations of biological signals (photosynthesis and respiration) through dissolved oxygen and pH dynamics.
- The relative influences of land-based sources (rivers, runoff) versus ocean waters (upwelling).

Moreover, it is the goal of the NEPs and their partners to analyze patterns and trends in aragonite saturation. Aragonite saturation state is commonly used to track ocean and coastal acidification because it is a measure of carbonate ion concentration. As aragonite saturation

state decreases, it is more difficult for organisms to build and maintain calcified structures, such that when saturation state is less than 1, shells and other aragonite structures can begin to dissolve. Calculating aragonite saturation requires that, in addition to temperature and salinity, at least two of the carbonate parameters ( $p\text{CO}_2$ , total alkalinity, DIC, pH) be known. However,  $p\text{CO}_2$  and pH data from the sensors are not an ideal set of input parameters for calculating aragonite saturation (i.e. using the CO2SYS software package) because they carry the most uncertainty (Orr et al, 2018). Discrete samples analyzed for dissolved inorganic carbon (DIC) and/or alkalinity can be used in conjunction with pH and/or  $p\text{CO}_2$  to calculate aragonite saturation states and act as validation data for the *in situ* sensors, but many of the NEPs do not yet have the required discrete data available to make these calculations and therefore do not yet report time series of calcium carbonate saturation states. Those NEPs that have analyzed aragonite saturation have found that saturation levels are lower in the summer and are influenced by biological activity such as phytoplankton blooms and by freshwater and oceanic (upwelling) inputs. Below EPA summarizes the observations made by each of the NEPs.





## CASCO BAY

### Observed Patterns in pH and $p\text{CO}_2$

- Expected seasonality of pH,  $p\text{CO}_2$ , temperature, dissolved oxygen and salinity have been observed (Figures 3 and 4). The observations show that pH increases in the spring and decreases in the fall (Figure 5) and  $p\text{CO}_2$  decreases in the spring and increases in the fall (Figure 6).

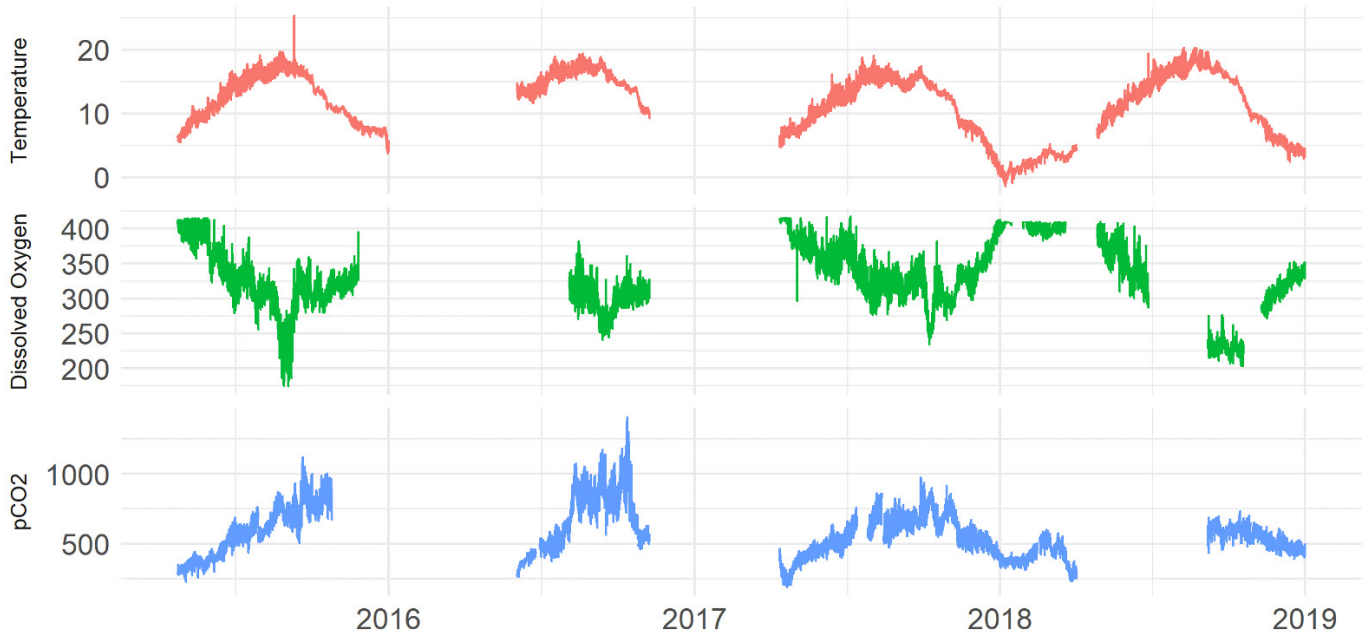

Figure 3. Observed seasonality of  $p\text{CO}_2$  ( $\mu\text{atm}$ ), DO (mg/L) and temperature ( $^{\circ}\text{C}$ ) observed. Casco Bay.

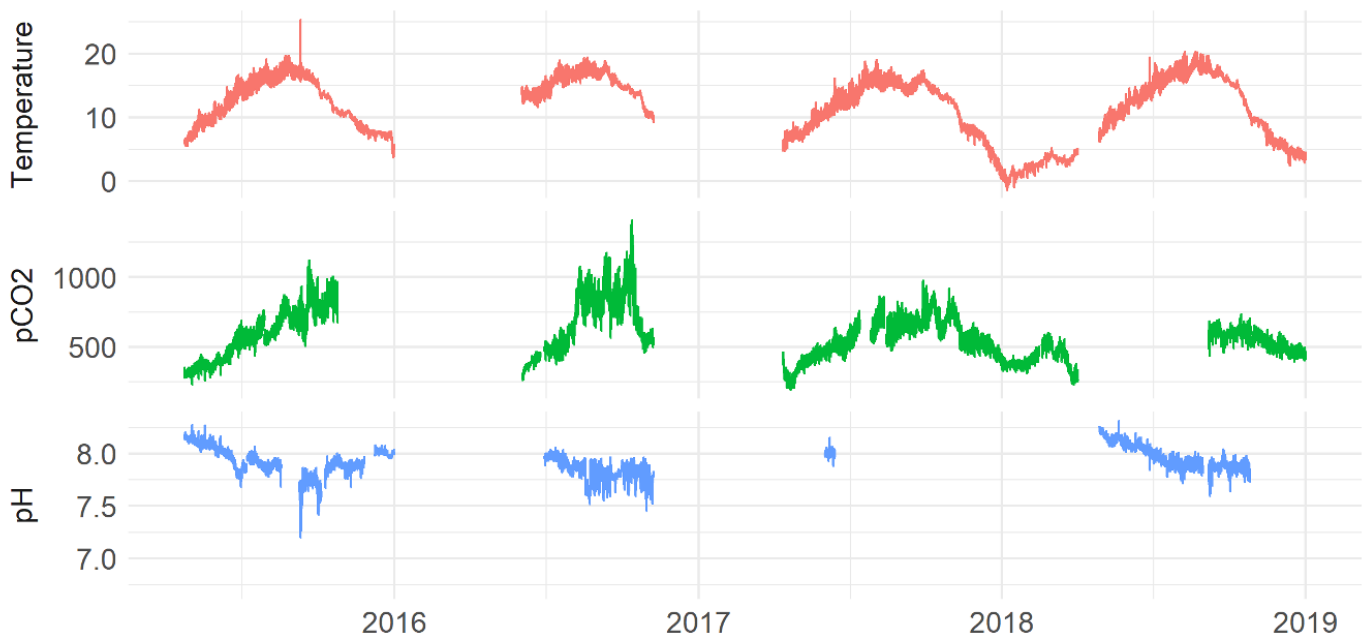

Figure 4. Observed seasonality of pH,  $p\text{CO}_2$  ( $\mu\text{atm}$ ), and temperature ( $^{\circ}\text{C}$ ) observed. Casco Bay.

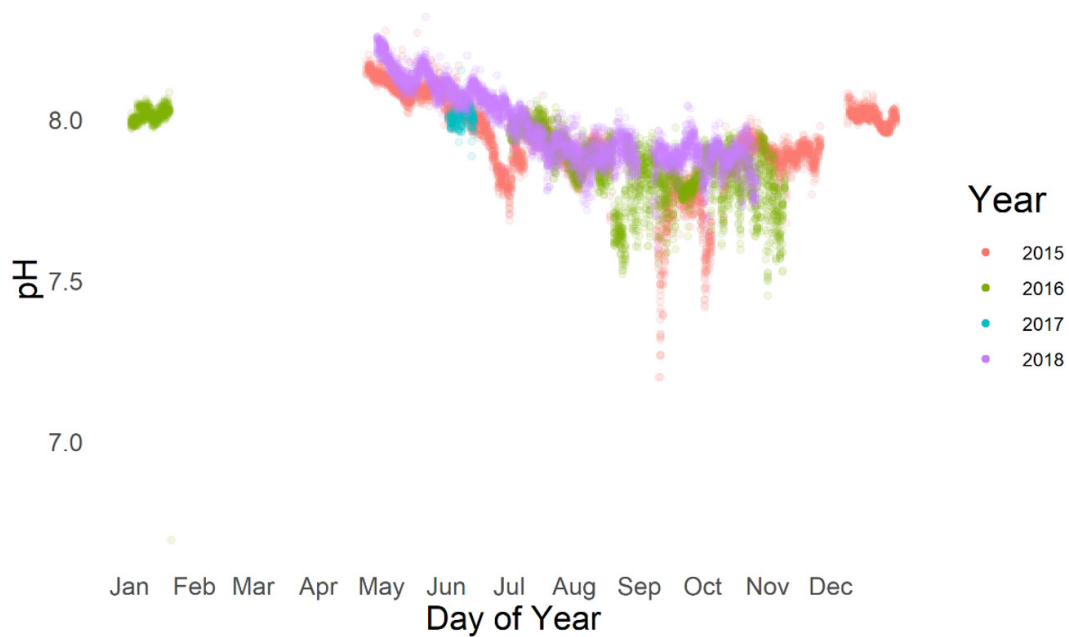

Figure 5. Observed pH increases in the spring and decreases in the fall. Casco Bay.

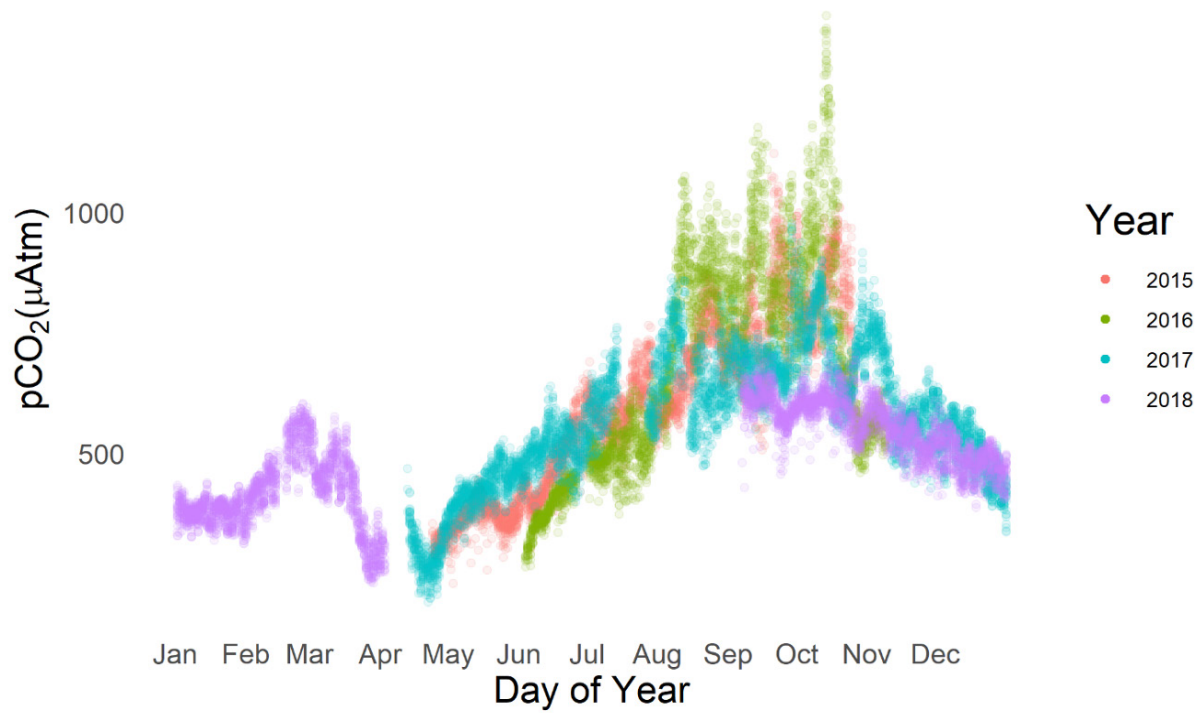

Figure 6. Observed pCO<sub>2</sub> decreases in the spring and increases in the fall. Casco Bay.

Relationship between carbonate parameters and other parameters

- Daily cycle in summer show the potential influence of production and respiration (indicated by DO) and tidal exchange on  $p\text{CO}_2$  levels (green arrows show elevated salinity, red arrows indicate times of low  $p\text{CO}_2$ ) (Figure 7). In 2016, tidal amplitude appears to influence  $p\text{CO}_2$  (Figure 8). Lower tidal amplitudes result in higher  $p\text{CO}_2$  in summer and fall. Water is less well mixed during neap tides, and respiration will result in higher  $p\text{CO}_2$  in bottom waters at our site. Casco Bay (Figure 8).

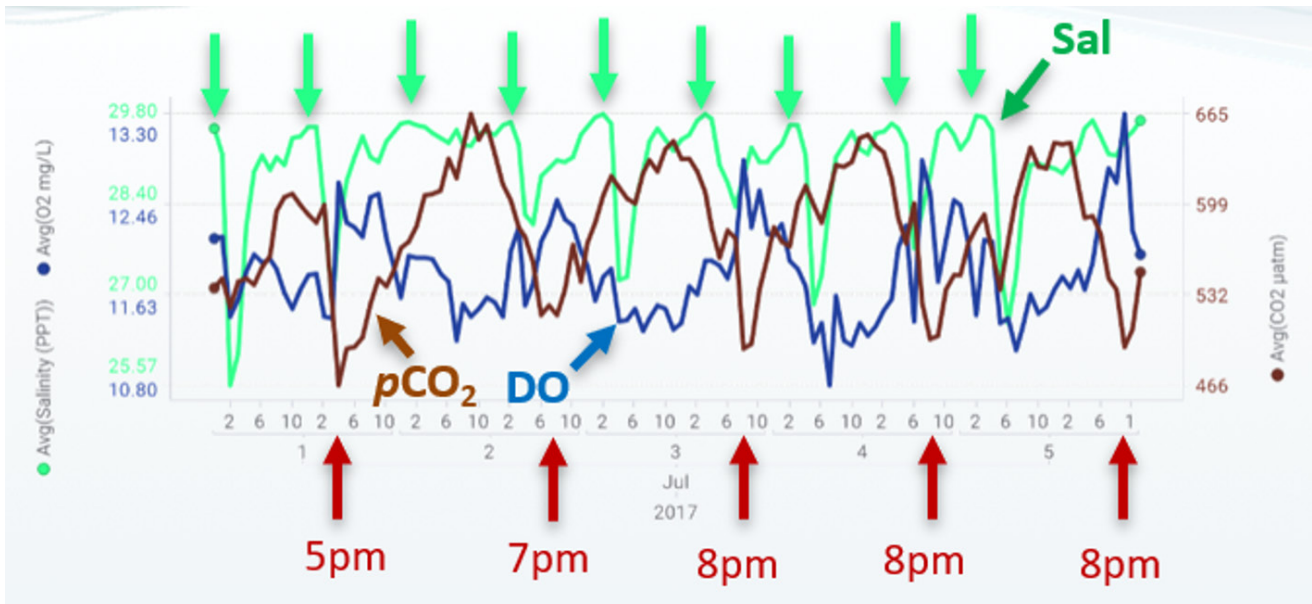

Figure 7. Observed daily variability of  $p\text{CO}_2$ , DO, and salinity (July 1-5, 2017).

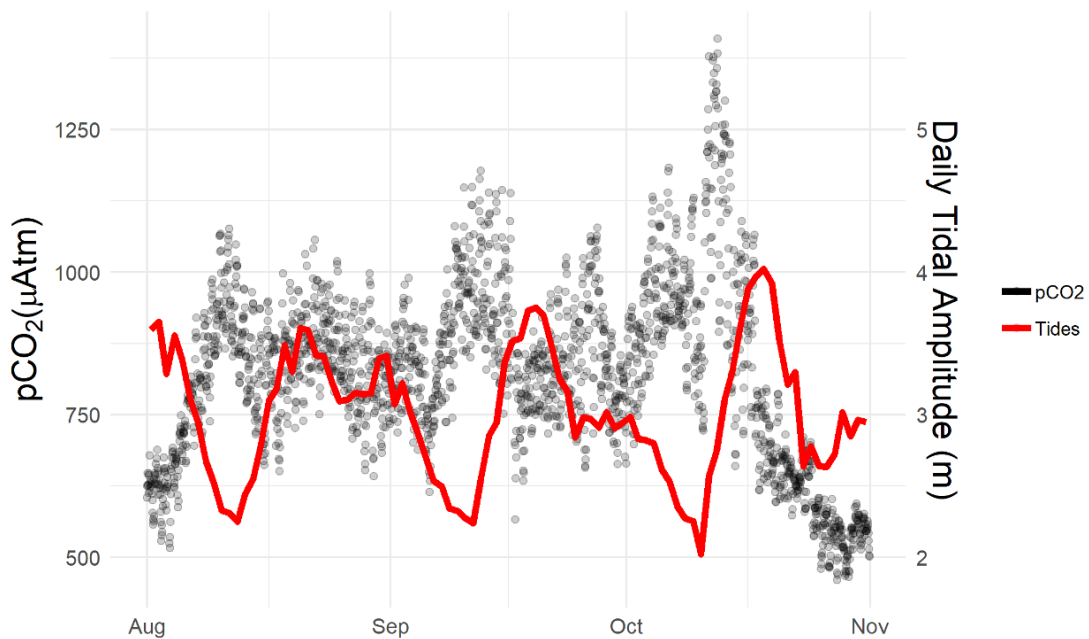

Figure 8. Observed tidal amplitude and pH,  $p\text{CO}_2$  in 2016. Casco Bay.

### Patterns in Aragonite Saturation

- In the first year (2015), aragonite saturation declined in July after a spring phytoplankton bloom (Figure 9). Over several years, aragonite saturation (omega) was typically lower in the fall (Figure 10). The influence of fresh water was detected. Saturation state influenced by rainfall and salinity. Precipitation brings in lower pH waters from watershed sources (Figure 11).

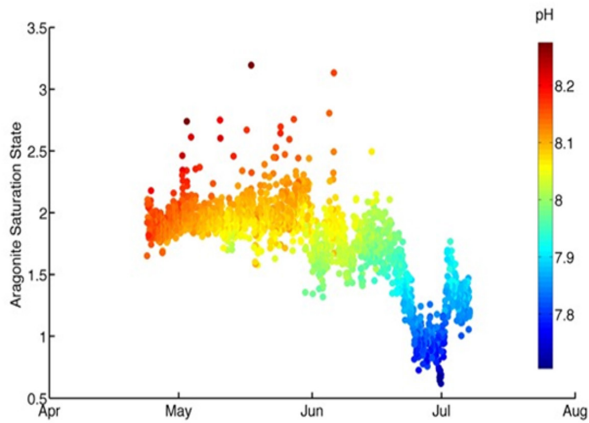

Figure 9. Aragonite Saturation State in 2015. Casco Bay.

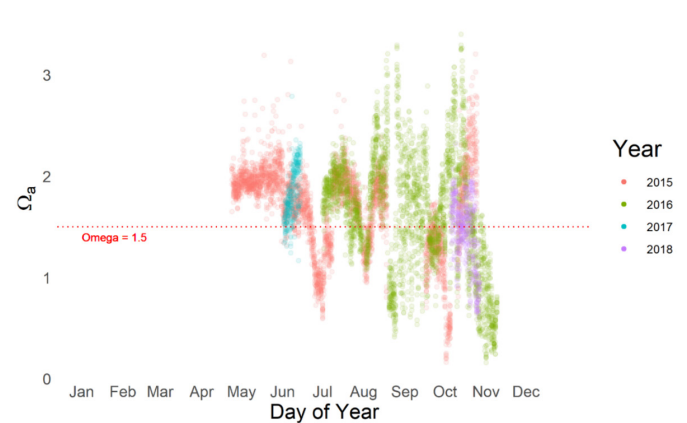

Figure 10. Aragonite Saturation State 2015–2018. Casco Bay.

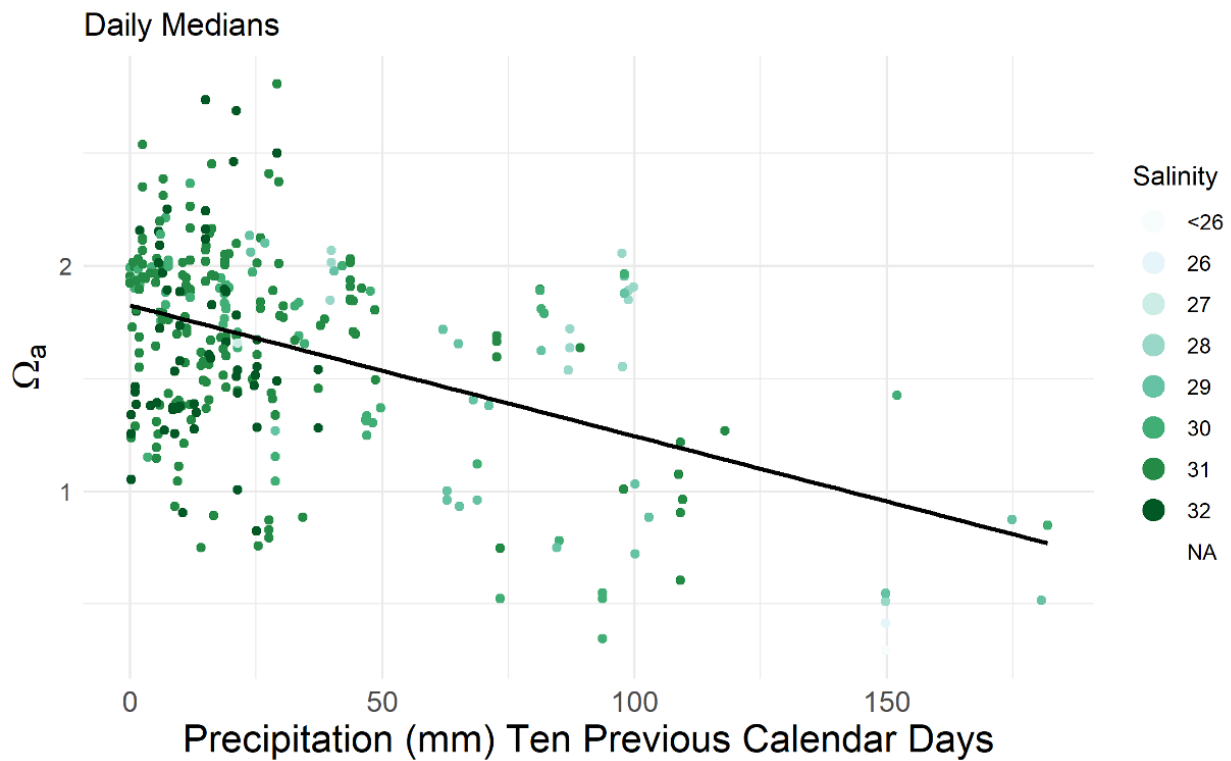

Figure 11. Observed aragonite saturation and precipitation. Casco Bay.

## LONG ISLAND SOUND

### Observed Patterns in pH and $p\text{CO}_2$

- A typical pattern of pH and  $p\text{CO}_2$  observed in Long Island Sound is shown in Figure 12 from the Western Long Island Sound (WLIS) station. The pH variability in Long Island Sound is five to ten times larger than the variability that occurs on the continental shelf. An inverse relationship between pH and  $p\text{CO}_2$ , where pH decreases as  $p\text{CO}_2$  increases can be observed, and is not unexpected as hydrogen ions are released as the  $\text{CO}_2$  is dissolved and dissociates.

### Relationship between carbonate parameters and other parameters

- The rate of change of  $\text{O}_2$  in the bottom waters is consistent with pH, because both are influenced by respiration. However, because of the large inter-annual variation in temperature and salinity, it will take a decade or two to see trends in the data.

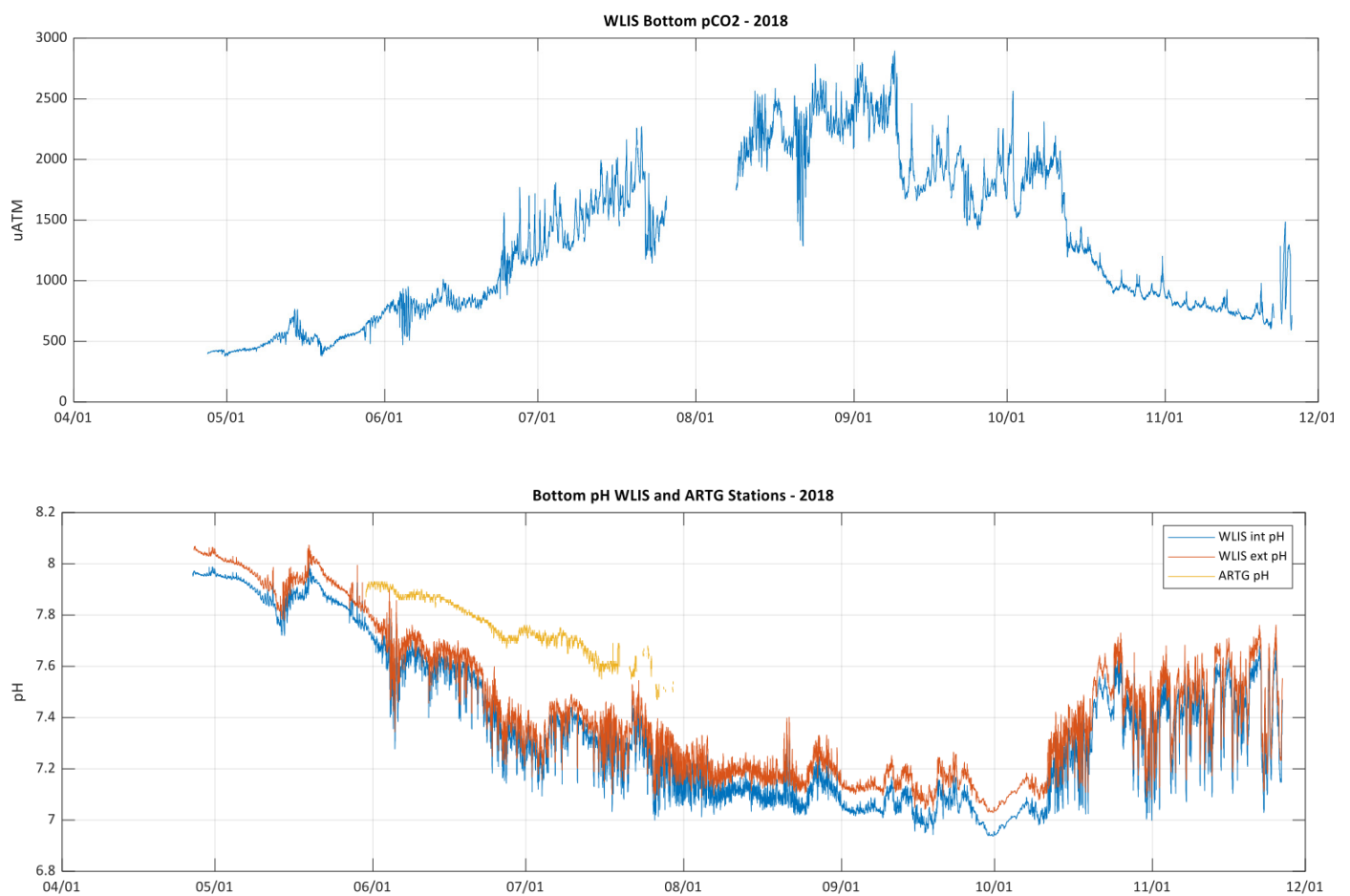

Figure 12. Time Series of pH and  $p\text{CO}_2$  from the WLIS station in Long Island Sound, April through December 2018. Bottom pH from ARTG is also shown, however the sensor failed and was removed in July.

## BARNEGAT BAY

### Observed Patterns in pH and $p\text{CO}_2$

- Data collected to date show a strong relationship between the pH and  $p\text{CO}_2$  (Figure 13), as  $p\text{CO}_2$  variability explained 93% of the variation in pH. This indicates that legacy pH data collected in the area (e.g., J.C. NERR station in Little Egg and New Jersey Department of Environmental Protection data) may be able to be used to estimate  $p\text{CO}_2$  and other carbonate parameters. This relationship will be explored further, when the instrumentation is redeployed at the estuary.

### Relationship between carbonate parameters and other parameters

- DO and pH relationships are indicative of photosynthesis and respiration processes. Where these parameters separate, other causes may be having an effect, such as freshwater input and upwelling.
- The NEP will need data from multiple years to see trends and relationships. The NEP would like to collect data over a couple of growing seasons to cover upwelling events more clearly (one upwelling event observed to date).

### Patterns in Aragonite Saturation

- Limited data collection in Little Egg harbor did not indicate pH conditions of concern for bivalves, although omega values can drop below 1 at night (see Figure 14).

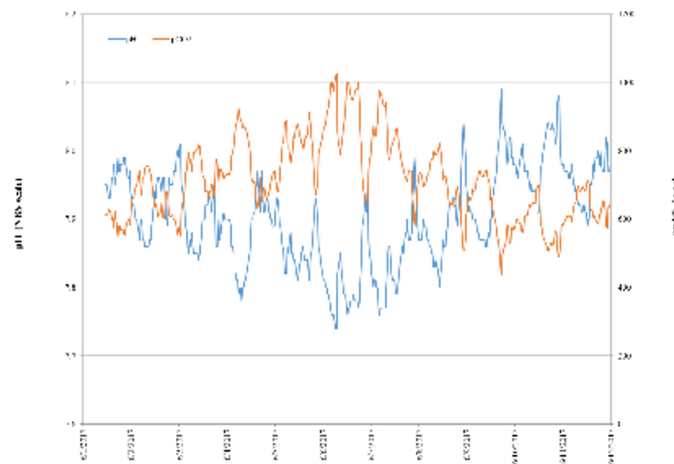

Figure 13. Barnegat Bay—Relationship of pH and  $p\text{CO}_2$

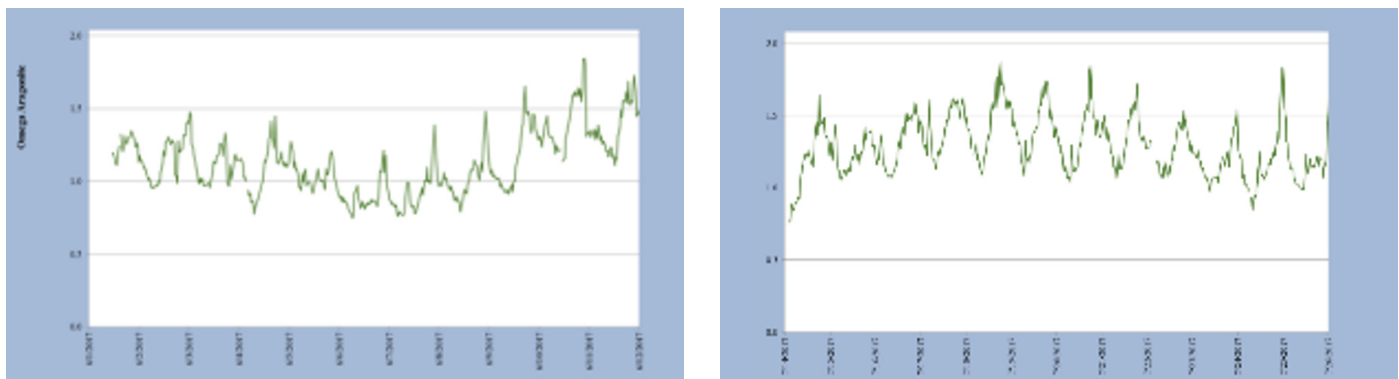

Figure 14. Barnegat Bay—Omega Aragonite in June and July 2017.

## TAMPA BAY

Observed Patterns in pH and  $p\text{CO}_2$  and other parameters

- The data (Yates et al. 2019) indicates evidence for tidal control (pressure) on pH and  $p\text{CO}_2$  on daily time scale (Figure 15). In addition, the data shows evidence for temperature control over weekly to monthly time scale (Figure 16).

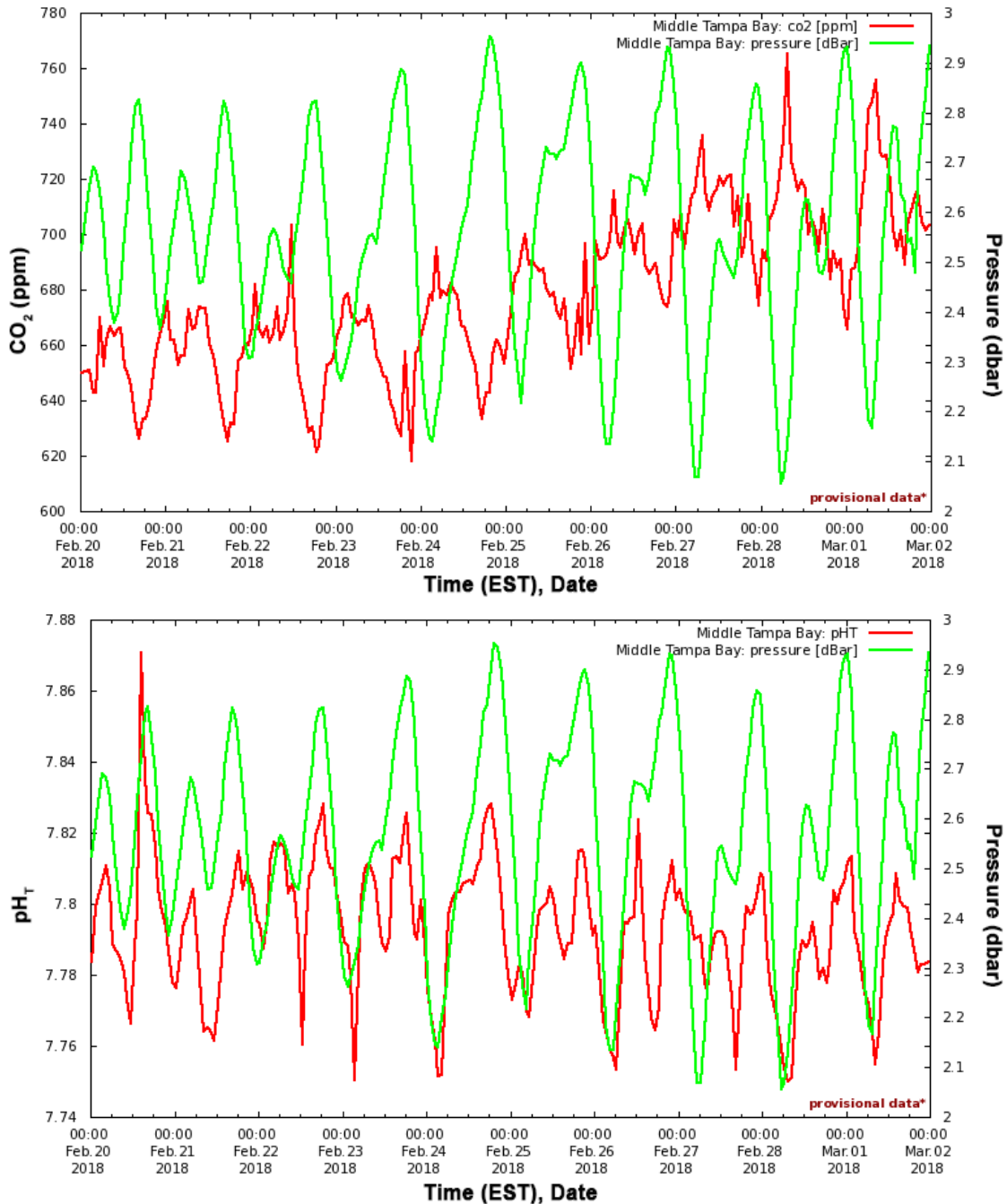

Figure 15. Tampa Bay—pH and  $p\text{CO}_2$  at Middle Tampa Bay in February and March 2018.

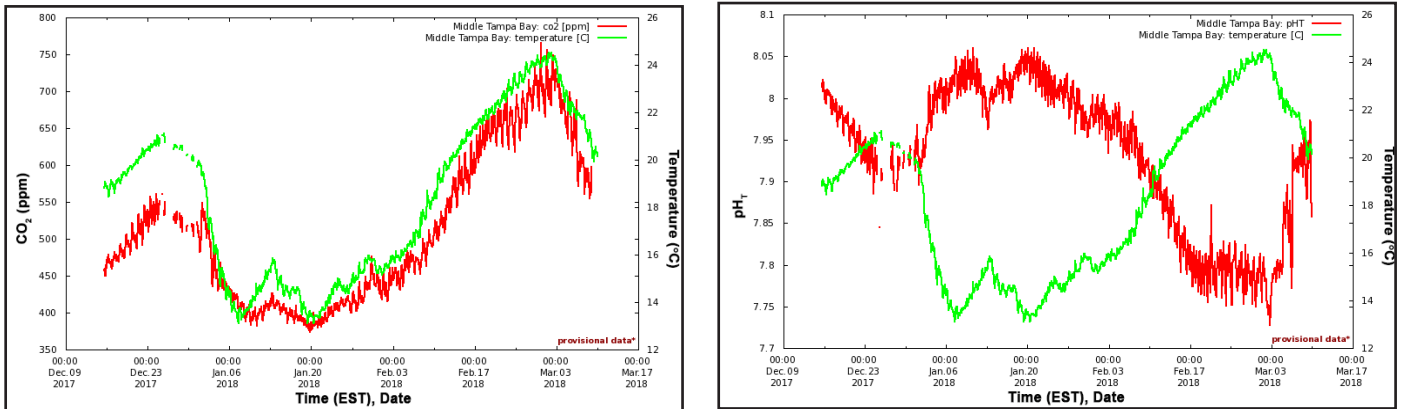

Figure 16. Tampa Bay – pH and  $p\text{CO}_2$  and Temperature (December 2017 to March 2018).

## COASTAL BEND BAYS

### Observed Patterns in pH and $p\text{CO}_2$

- High pH was observed for a majority of the monitoring period (Figure 17). During the approximately 10-month monitoring period, significant temporal variations of both  $p\text{CO}_2$  and pH were observed with a range of 251.2 to 619.7 micro atmosphere ( $\mu\text{atm}$ ) and 7.789 to 8.451, respectively.
- Seasonal fluctuations and diel variability were observed. Higher  $p\text{CO}_2$  and lower pH were observed during summer and lower  $p\text{CO}_2$  and high pH were observed during winter. Diel variability was higher during the summer months for  $p\text{CO}_2$  and during the winter months for pH.

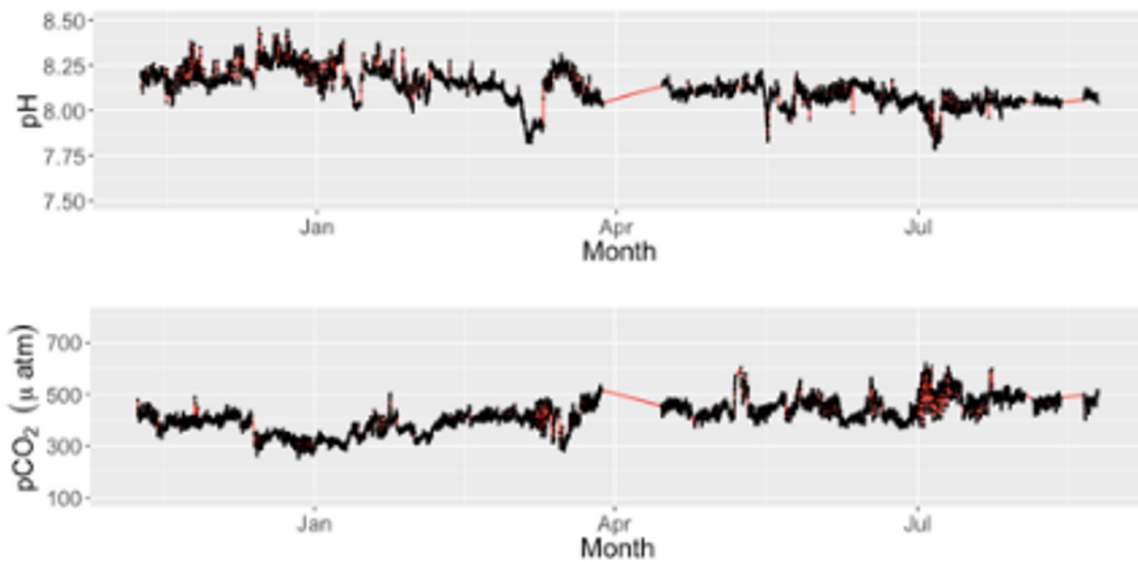

Figure 17. Coastal Bend Bays – pH and  $p\text{CO}_2$  data during the deployment period. The black data points represent hourly measurements. Gaps between points occur when there were outliers due to various reasons.



#### Relationship between carbonate parameters and other parameters

- Salinity and temperature both exerted controls on the variations of  $p\text{CO}_2$  and pH at different extents, indicating sensitivity of the estuarine water carbonate system to changes in both hydrological condition and temperature. Carbonate alkalinity (C-Alk) was calculated based on  $p\text{CO}_2$  and pH data and was generally higher in winter months and lower in summer months. C-Alk also showed an inverse relationship with salinity.
- River discharge does not correlate well with salinity variability. There were no observed large pulses of freshwater inflow during the time period to impact salinity or carbonate system. Salinity variability was likely from local precipitation, evaporation, and tidal influence.

#### Patterns in Aragonite Saturation

- Carbonate saturation state with respect to omega aragonite ( $\Omega_{\text{Ar}}$ , the mineral for larval stage oysters) had a mean of 4.50, but it did drop to undersaturation (minimum 0.91) for a short period of time. Nevertheless,  $\Omega_{\text{Ar}}$  was greater than 1 for 99.8% of the time, and greater than 2 for 95.9% of time, indicating overall optimal but occasional sub-optimal condition in the Aransas Ship Channel, which serves as a conduit for the Mission-Aransas Estuary and the Gulf coast (Figure 18). More details can be found in Hu et al. 2018.

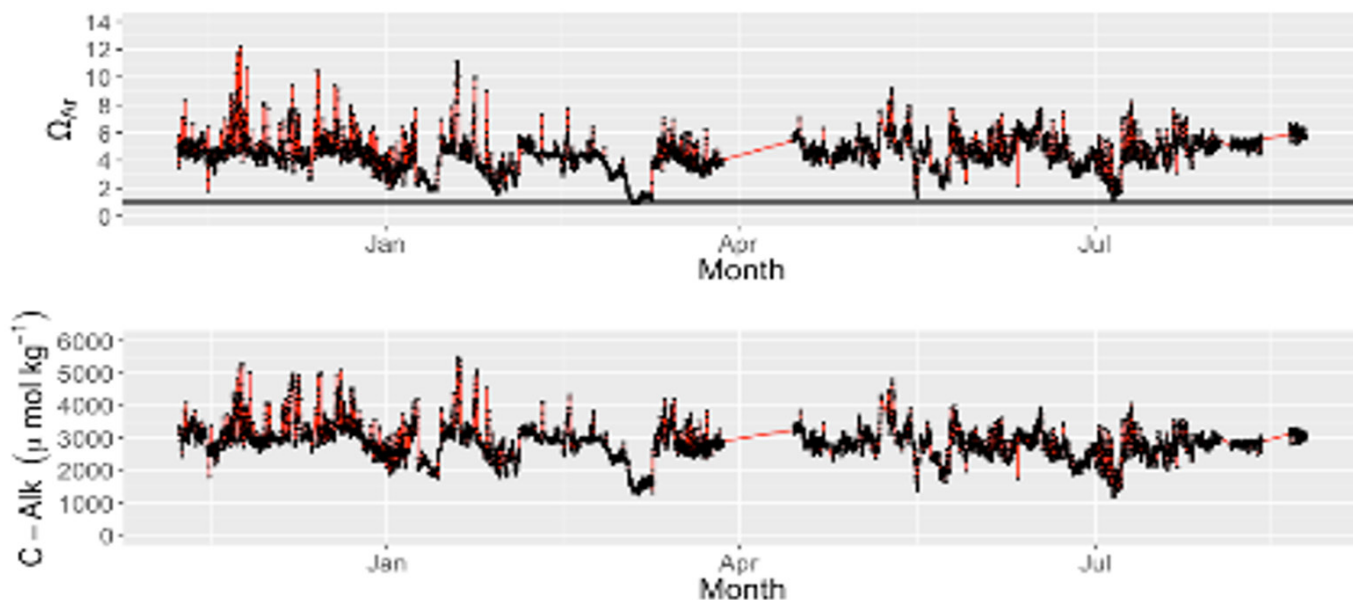

Figure 18. Coastal Bend Bays—Calculated saturation state of aragonite and carbonate alkalinity during the deployment period. The black data points represent hourly measurements. Gaps between points occur when there were outliers due to various reasons.

## SANTA MONICA BAY

### Observed Patterns in pH and $p\text{CO}_2$

- Year 1 deployment data show significant temporal variability in pH at the fixed depth of 15 m (Figure 19) (LACSD, 2019). Significant temporal variability in pH was also observed during the Year 2 deployment at 60 m. These time series suggest that vertical water movements at tidal to seasonal time scales are likely responsible for much of the observed variability in pH at the mooring.
- $p\text{CO}_2$  values during the first period of the deployment were relatively constant, but during the spring upwelling season (March through May), the  $p\text{CO}_2$  levels rose considerably, and more high frequency variability was observed (Figure 20) (LACSD, 2019). Relative to the shallower first year data, the Year 2 deployment at 60 m show less variability in the  $p\text{CO}_2$  measured at this deeper depth. Levels are generally higher than those observed during the first year, which was expected because this deeper location was consistently below the pycnocline (the layer where the water density gradient is greatest).  $p\text{CO}_2$  levels were highest during the spring upwelling period.

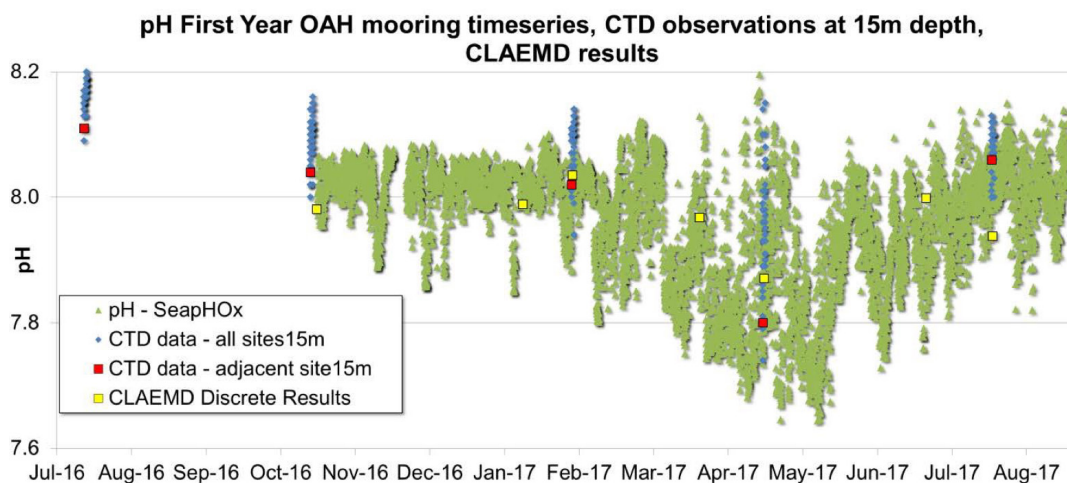

Figure 19. Santa Monica Bay—First Year pH time series. CLAEMD results are adjusted for temperature and pressure.

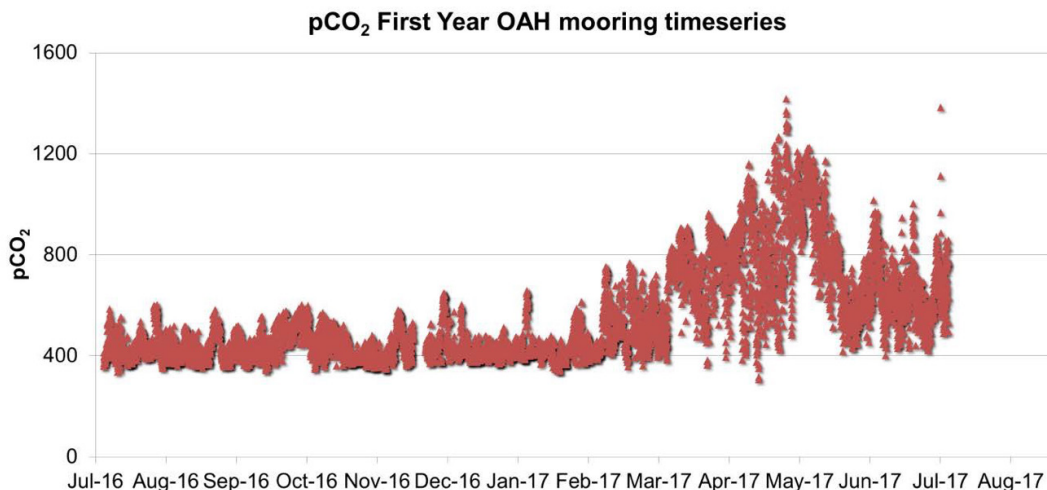

Figure 20. Santa Monica Bay—First Year  $p\text{CO}_2$  Time Series.

### Relationship between carbonate parameters and other parameters

- Consistent with expected oceanographic stratification, the pH and temperature correlate quite closely,  $p\text{CO}_2$  is roughly inversely correlated with temperature, pH and  $p\text{CO}_2$  are inversely correlated, and oxygen and pH are strongly correlated (LACSD, 2019). The relatively strong relationships between parameters suggest that it may be possible to directly compute pH or  $p\text{CO}_2$  using temperature, salinity, and oxygen. This could provide a simple way to estimate  $\Omega_{\text{arag}}$  and could be used to check and confirm that directly measured pH and  $p\text{CO}_2$  values were valid (Figure 21).

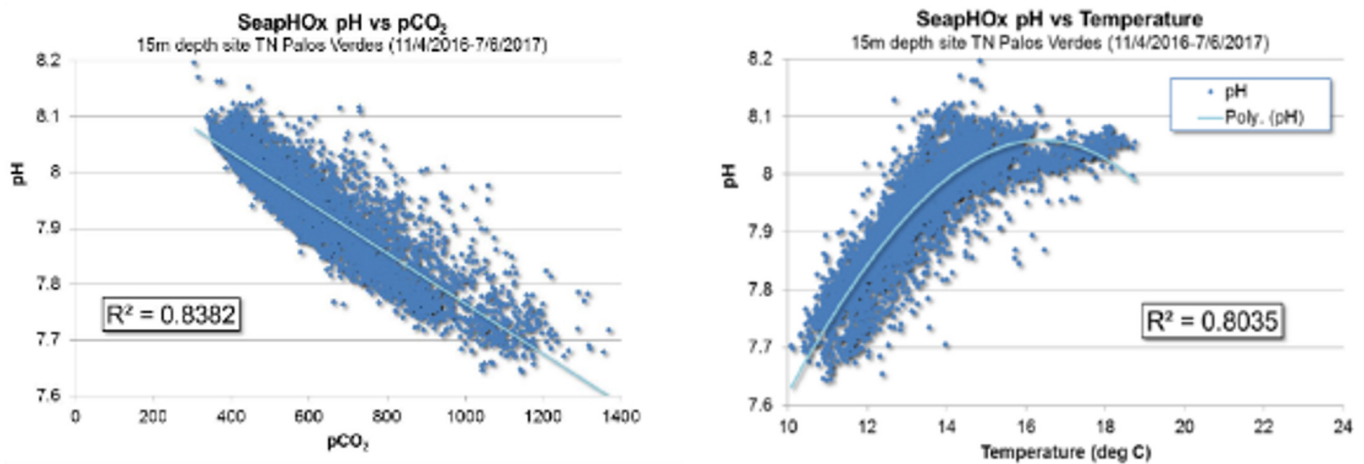

Figure 21. Santa Monica Bay—Relationship of pH and  $p\text{CO}_2$  (left) and pH and temperature (right) in Year 1

## Patterns in Aragonite Saturation

- During the later period of the Year 1 deployment, and during the spring upwelling period, the aragonite saturation level drops, and high frequency variability increases (Figure 22) (LACSD, 2019). Based on the collected mooring data, the lowest aragonite saturation values occurred in the spring, and were likely due to upwelling, which pushes colder water with lower pH and higher  $p\text{CO}_2$  towards the surface, thereby decreasing aragonite saturation. Year 2 aragonite saturation levels were far less variable than the first year, since the mooring at 60 m was below the pycnocline at all times. Lowest levels were seen during the spring upwelling period (Figure 23). In all seasons, the aragonite saturation was generally above 1.7, and unlikely to be a concern for shell building organisms. Biologically significant levels of saturation below 1.7 and 1.4 were only observed during the spring upwelling periods and were almost never below 1.

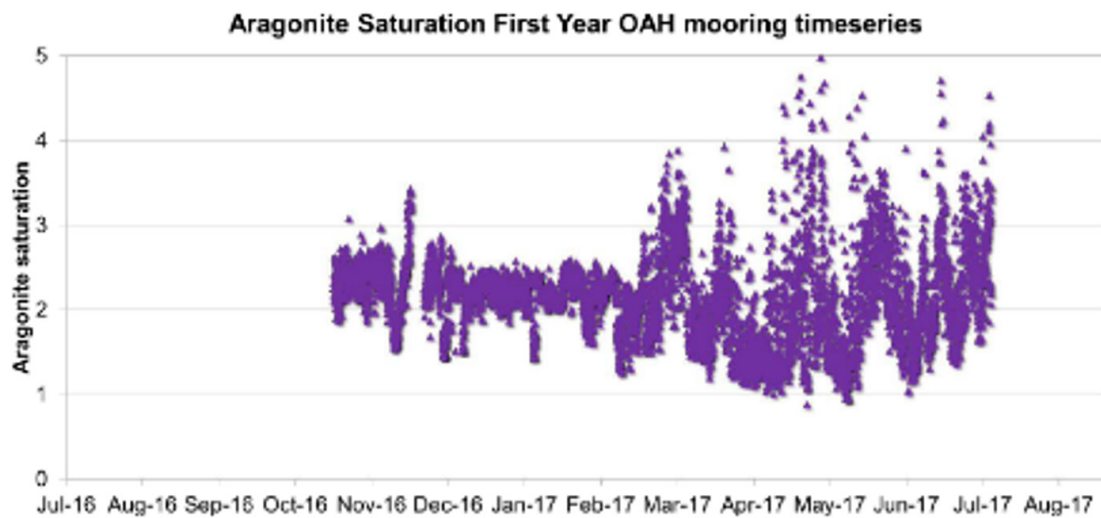

Figure 22. Santa Monica Bay–First Year Aragonite Saturation Time Series

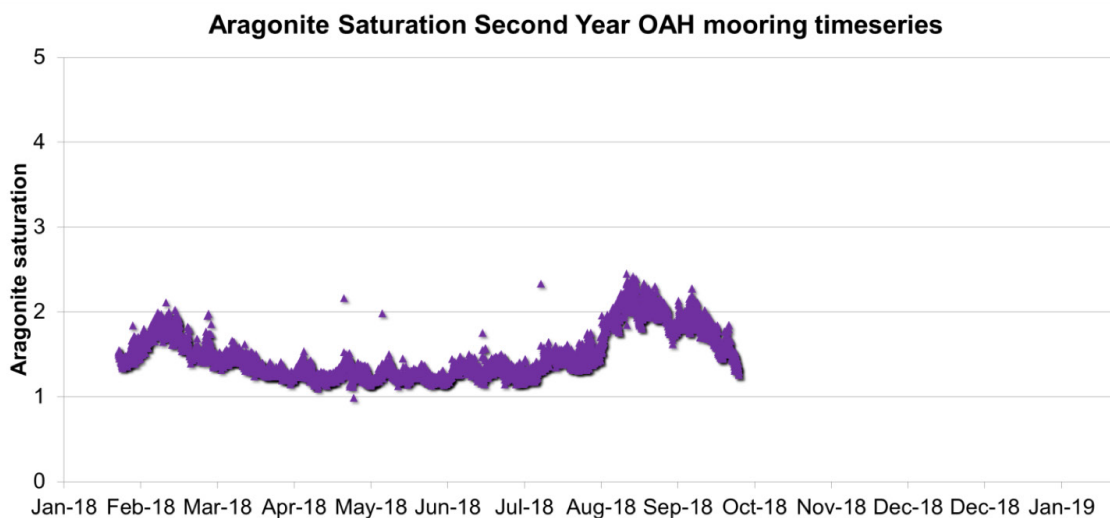

Figure 23. Santa Monica Bay–Second Year Aragonite Saturation Time Series

## SAN FRANCISCO ESTUARY

### Observed Patterns in pH and $p\text{CO}_2$

- Ocean and watershed sources of high  $p\text{CO}_2$  were observed. In addition, the ocean was identified as the source for low DO (Figure 24).
- Tidal correlation between salinity and  $p\text{CO}_2$  was observed, but it shifts between positive correlation (e.g., February 2018) and negative correlation (e.g., March 2018) (Figure 25).
- There is a clear signal of low-pH water coming in from the ocean. Signals of upwelling and land runoff (freshwater) are seen in the data. Physical data are aligned with the working hypothesis that there is a confluence of oceanic inputs with high freshwater runoff in the spring and influence of both runoff and ocean water are seen in the data.
- No true data interpretation has happened yet due to limited funding.

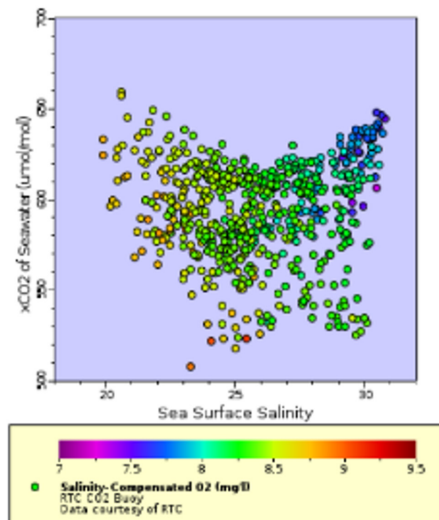

Figure 24. San Francisco Estuary–Ocean and watershed sources of high  $p\text{CO}_2$

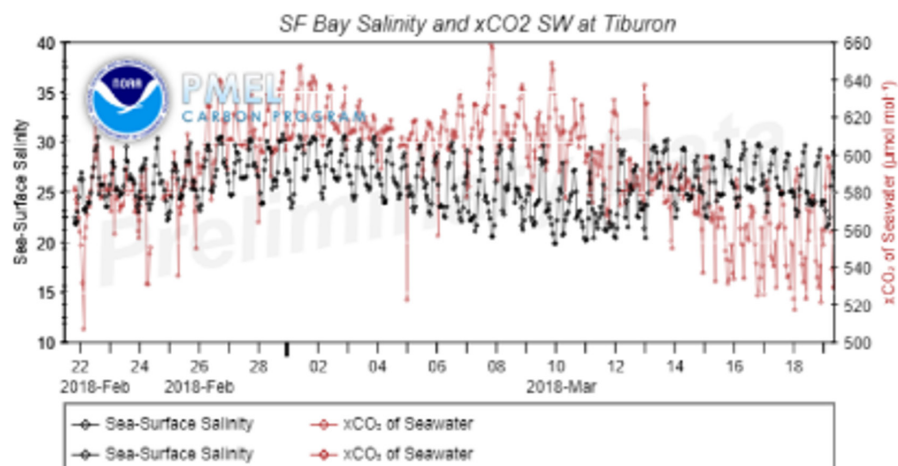

Figure 25. San Francisco Estuary–Salinity- $p\text{CO}_2$  relationship

## TILLAMOOK ESTUARY

### Observed Patterns in pH and $p\text{CO}_2$

- Tillamook Estuary is just beginning to analyze aragonite saturation state data (Figure 26). To date, they have observed that aragonite saturation is lowest during the summer indicating upwelling and coastal influence, as well as during winter low salinity periods associated with freshwater inflow.

### Relationship between carbonate parameters and other parameters

- River surveys in the Tillamook watershed are being used to understand how seasonal changes in river end-member chemistry impact estuarine carbonate chemistry.
- They used mixing models to distinguish watershed versus oceanic influences in the estuary (Figure 26).

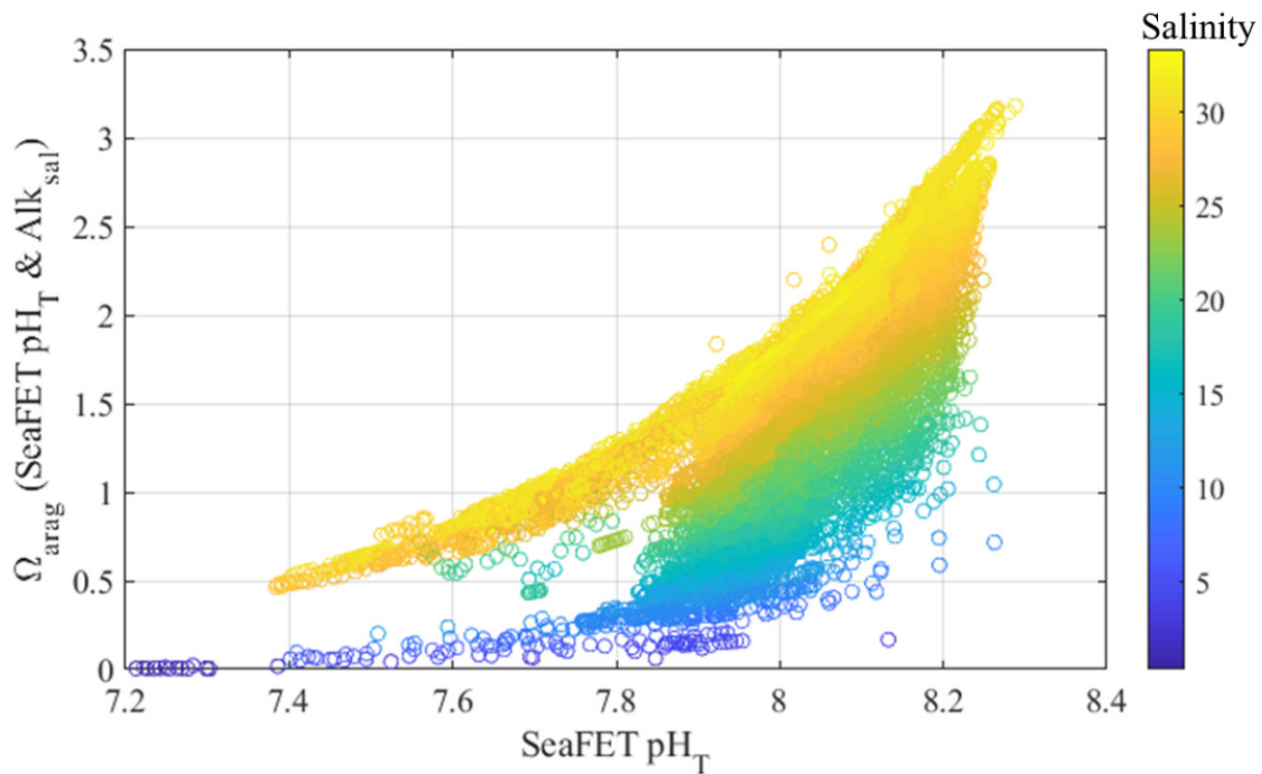

Figure 26. Scatterplot of SeaFET  $\text{pH}_T$  and  $\Omega_{\text{arag}}$  (calculated with SeaFET  $\text{pH}_T$  and salinity-derived alkalinity) at the Garibaldi Dock mooring in Tillamook Estuary, OR from August 2017 to August 2019.

## Next Steps

While these preliminary data provide important baseline information necessary to elucidate trends and the potential drivers of acidification, long-term measurements are needed to clarify and confirm trends. The inherent challenge of characterizing carbonate chemistry in estuarine systems underscores the value of continuous data and sustained monitoring programs. EPA believes that sharing the methodologies and lessons learned in this report will lead to information sharing and technology transfer that will benefit the NEP community and other coastal monitoring groups.

The NEPs identified in this report are at various stages in their deployments, collecting discrete measurements, analyzing their data, reporting, performing outreach, seeking additional funding, and identifying opportunities for collaboration. The NEPs are integrating their preliminary results into actionable plans in several ways including their Comprehensive Conservation and Management Plans (CCMP), State of the Bay reports and other opportunities in which stakeholders can work together to access and use the data to inform future monitoring efforts and other actions of the NEPs. Below is a summary of next steps for coastal acidification monitoring actions within the ten NEPs.

NEP	NEXT STEPS
<b>EAST COAST</b>	
Casco Bay	<ul style="list-style-type: none"> <li>• Submit the data to an on-line repository.</li> <li>• Publish the monitoring data in a peer review journal and include in the next State of the Bay report.</li> <li>• The NEP will collaborate with the ocean acidification information exchange (OAIE) set up by NECAN/NERACOOS and with the MOCA Partnership to share the data.</li> <li>• Casco Bay does not currently plan to continue this monitoring; however, a non-profit partner, Friends of Casco Bay has established a water quality monitoring station and is planning to have two additional stations operating by the end of the year, which will include coastal acidification parameters, at different locations in the Bay.</li> </ul>
MassBays	<ul style="list-style-type: none"> <li>• As some challenges have been addressed, the system was deployed in spring 2020. This was undertaken through a staged deployment. In January 2020, the pumping system was installed and tested as to how it will hold up to cold temperatures, possible icy conditions, storms, and wind. In June 2020, seawater was pumped through the system for several hours to monitor the temperature, bubble, and flow conditions. The system was tested for several months during which time a new thermosalinograph was installed and technical improvements made to refine the system. The system will be retested <i>in situ</i> in April 2021 and will be ready to start compiling data. Finally, telemetry will be added in order to download data directly to UMass Boston. Train volunteers for sample collection (Spring 2021).</li> <li>• Collect discrete samples to ground-truth data (bi-weekly samples starting June 2021).</li> <li>• Coordinate with Narragansett Lab to analyze water samples for TA and DIC (ongoing).</li> <li>• Develop outreach to share information with local communities on what the system seeks to measure. Materials will be developed and a system to stream data online will be developed.</li> <li>• Make data available to the Massachusetts Ocean Acidification Commission established by the Massachusetts legislature in 2018, the Massachusetts Shellfish Initiative, the shellfish industry, and other stakeholders.</li> </ul>

NEP	NEXT STEPS
Long Island Sound	<ul style="list-style-type: none"> <li>• Developing the budget to secure funding to make the system more reliable, integrate it and sustain over the next two to three years.</li> <li>• There is a need to establish a program in all the estuaries to understand what the variability in trends of pH and saturation concentrations are going to be.</li> </ul>
Barnegat Bay	<ul style="list-style-type: none"> <li>• Continue deployments and collect data during non-winter months.</li> <li>• Develop partnerships to collect discrete samples for comparisons/validations.</li> <li>• Work with other monitoring programs to develop a shared robust QA/QC procedure.</li> <li>• Identify an appropriate open-access repository for the data.</li> </ul>
<b>GULF OF MEXICO</b>	
Tampa Bay	<ul style="list-style-type: none"> <li>• Migrate satellite telemetry system to University of South Florida system, because the Southeast Coastal Ocean Observing Regional Association (SECOORA) and the National Centers Environmental Information (NCEI) did not have graphing capability. COMPS team updating website and add graphing capabilities.</li> <li>• Continue collaboration with Dr. Bob Weisberg and J. Law, USF to examine hydrodynamic controls on water chemistry.</li> <li>• Synthesize data and compare trends and variability at Tampa Bay and Gulf of Mexico monitoring locations.</li> </ul>
Mobile Bay	<ul style="list-style-type: none"> <li>• SeapHOX and SAMI-<math>p\text{CO}_2</math> Instruments will be deployed in the field in fall 2021.</li> <li>• Monthly bay-wide discrete sampling program began in spring 2020 and will continue through at least 2024.</li> <li>• Biogeochemical model is being developed for the Bay to understand drivers of coastal acidification such as trends and variability in freshwater inflows, eutrophication, and mixing with Gulf of Mexico waters.</li> </ul>
Coastal Bend Bays	<ul style="list-style-type: none"> <li>• Since the pier was destroyed, seeking another site in productive waters to deploy the system or wait for the research pier to be rebuilt.</li> <li>• Continue discrete water collection.</li> </ul>



## WEST COAST

## Santa Monica Bay

- In early 2019, the Los Angeles Sanitation Districts received approval from the Los Angeles Regional Water Quality Control Board for a new Special Study, which will include continued use of the SMB/NEP sensors in coordination with a Wirewalker mooring with a full CTD package, fluorescence sensors, and an on-board pH sensor. This mooring will be deployed in Santa Monica Bay for a 12-month period beginning in Spring 2021. The Wirewalker will allow the sensor array to measure vertical profiles from the surface to 330 feet and transmit real-time data with a telemetry system (<http://delmarocean.com/wirewalker/>).
- The data from the Wirewalker will allow continued bay-scale assessment of causes and dynamics of acidification: When and at what depths is acidification and hypoxia occurring? What is the role of seasonal cycles, phytoplankton blooms, and other local drivers on observed ocean acidification and hypoxia? Can any anthropogenic associated local effect on ocean acidification and hypoxia be determined?
- Support ongoing research to determine if local, nutrient-related sources (wastewater discharges) to the Bay are contributing to ocean acidification (at ecologically significant levels). Ultimately provide supporting data for any management actions.
- Determine if coastal acidification can be ameliorated by increasing uptake via restoration of submerged aquatic vegetation, which has been shown to have some muted, but potentially significant, benefits in increasing pH, increasing DO, and decreasing pCO<sub>2</sub>. We are in the research stage and looking into growing giant kelp forests and eelgrass offshore populations.

## San Francisco Estuary

- There is a lot that we still do not know about the carbonate chemistry of the San Francisco Estuary. Our focus so far has been on the deeper main channel dynamics, with an emphasis on understanding the characteristics of source waters arriving in the Central SF Bay, and the processes delivering them.
- We continue to work on identifying low-pH and low-oxygen events due to intrusion of upwelled water from the ocean and assessing its impact through determining in-bay modification and residence of these hypoxic intrusions.
- We also continue to explore importance of freshwater inflow concurrent with intrusion of low-pH, hypoxic ocean waters.
- Next steps include a focus on the shallower areas outside of the main channel and the role of biological processes, especially by submerged aquatic and intertidal macrophytes and benthic algae, in driving biogeochemical changes in the less studied shallow habitats of the estuary which support a diversity of ecologically important species and functions.
- There is a need to raise funding to sustain operations and conduct data analysis. We are engaging with additional regional collaborators and stakeholders toward this end.
- We look forward to collaborating with the NOAA Coastwide cruise in the future, as the conditions of the pandemic allow, to conduct comparative, cross-calibration of samples.

## NEP

## NEXT STEPS

### Tillamook Estuary

- Exploring estuary-scale assessment of causes and dynamics of acidification to inform mitigation and adaptation strategies: When and where are acidification and hypoxia occurring? What is the role of local drivers versus ocean conditions on occurrence of estuarine acidification and hypoxia? Developing approaches to identify anthropogenic signals in acidification.
- Tillamook Estuaries Partnership (TEP) and the Oregon Ocean Acidification and Hypoxia Monitoring Workgroup received a \$60,000 grant from the State of Oregon to purchase three additional SeaFET and YSI instruments and conduct additional data collection near oyster beds. This work will help build an ocean acidification monitoring network in Oregon. Instrumentation for this expedited two-year effort were deployed in July and August of 2019. TEP has met with significant challenges with implementation of this effort as identified in sections of this report. TEP will continue to refine its deployment strategies to overcome obstacles and coordinate with research partners to produce and disseminate results.
- TEP received EPA funding to purchase and install a telemetry system in Tillamook Bay. TEP will collaborate with EPA ORD staff to design and install the system, beginning in spring 2021. In addition to allowing provision of real-time data to partners, the telemetry system will allow TEP to seamlessly identify data abnormalities, biofouling, and equipment failure, without significant interruption in data collection.

## References

---

- Bushinsky, S.M., Takeshita, Y. & Williams, N.L. 2019. Observing Changes in Ocean Carbonate Chemistry: Our Autonomous Future. *Curr Clim Change Rep* 5, 207–220. <https://doi.org/10.1007/s40641-019-00129-8>
- Dickson, A. G., Sabine, C.L., and Christian, J.R. 2007. Guide to best practices for ocean CO<sub>2</sub> measurements. PICES Special Publication 3. 191 pp.
- Hönisch et al., 2012. The Geological Record of Ocean Acidification. *Science*. 335 (6072).
- Hu, X., McCutcheon, M.R., Saryk, C.J. 2018. [Ocean and coastal acidification monitoring. Final Report to the Coastal Bend Bays and Estuaries Program](#), Contract #1605. Department of Physical and Environmental Sciences, Texas A&M University-Corpus Christi, Corpus Christi, TX, 24 p.
- IAWGOA, 2014. Strategic Plan for Federal Research and Monitoring of Ocean Acidification. Prepared by the Interagency Working Group on Ocean Acidification (IAWGOA). March 2014.
- Kelly et al. 2011. Mitigating Local Causes of Ocean Acidification with Existing Laws. *Science*. Vol. 322 (6033): 1036-7.
- Lewis, E. and Wallace, D.W.R. 1998. Program Developed for CO<sub>2</sub> System Calculations, ORNL/CDIAC-105. Carbon Dioxide Information Analysis Center, Oak Ridge National Laboratory, U.S. Department of Energy, Oak Ridge, TN.
- Los Angeles County Sanitation Districts (LACSD). 2019. Baseline Assessment of Hypoxia and Ocean Acidification Events near the Seafloor in Santa Monica Bay (JWSS-16-002). Final Report May 15.
- National Research Council (NRC). 2010. Ocean Acidification: A national strategy to meet the challenges of a changing ocean. *National Academies Press*, ISBN: 978-0-309-15359-1.
- Northcott, D., Sevadjian, J., Sancho-Gallegos, D.A., Wahl, C., Friederich, J. and Chavez, F.P., 2019. Impacts of urban carbon dioxide emissions on sea-air flux and ocean acidification in nearshore waters. *PLoS one*, 14(3).
- Orr et al. 2005. Anthropogenic ocean acidification over the twenty-first century and its impact on calcifying organisms. *Nature* 437: 681-686.
- Orr, J.C., Epitalon, J.-M., Dickson, A.G. and Gattuso, J.-P., 2018. Routine uncertainty propagation for the marine carbon dioxide system. *Marine Chemistry*, 207, 84-107.
- Pacella, S, C. Brown, J. Kaldy, T. MochonCollura, R. Labiosa, E. Rutila, B. Hales and G. Waldbusser. Observations and drivers of coastal acidification in Pacific Northwest estuaries. Hatfield Marine Science Center Research Seminar Series, March 4, 2021, Newport, Oregon.
- Pimenta, A. R. and Jason S. Gear. 2018. [Guidelines for Measuring Changes in Seawater pH and Associated Carbonate Chemistry in Coastal Environments of the Eastern United States](#). EPA/600/R-17/483 Atlantic Ecology Division. National Health and Environmental Effects Research Laboratory, Narragansett, RI.
- Royal Society. 2005. Ocean acidification due to increasing atmospheric carbon dioxide. ISBN 0 85403 617 2.
- Sastri, Akash R. et al. 2019. Perspectives on in situ Sensors for Ocean Acidification Research. *Frontiers in Marine Science*. 6:653. <https://www.frontiersin.org/article/10.3389/fmars.2019.00653>
- Wallace, R. B., Hannes Baumann, Jason S. Gear. Robert C. Aller, and Christopher J. Gobler. 2014. Coastal ocean acidification: The other eutrophication problem. *Estuarine, Coastal and Shelf Science*. Elsevier Science Ltd, New York, NY, 148:1-13, (2014).
- Yates, K.K., Moore, C.S., and Lemon, M.K., 2019, Time series of autonomous carbonate system parameter measurements in Middle Tampa Bay, Florida, USA (ver. 3.0, March 2021): U.S. Geological Survey data release, <https://doi.org/10.5066/P9BAFC7L>.
- Yates, K.K., Moore, C.S., Goldstein, N.H., and Sherwood, E.T., 2019, Tampa Bay Ocean and Coastal Acidification Monitoring Quality Assurance Project Plan: U.S. Geological Survey Open-File Report 2019–1003, 35 p